

EIF SS Boys Individuals Central Div

EIF Qualifier 106

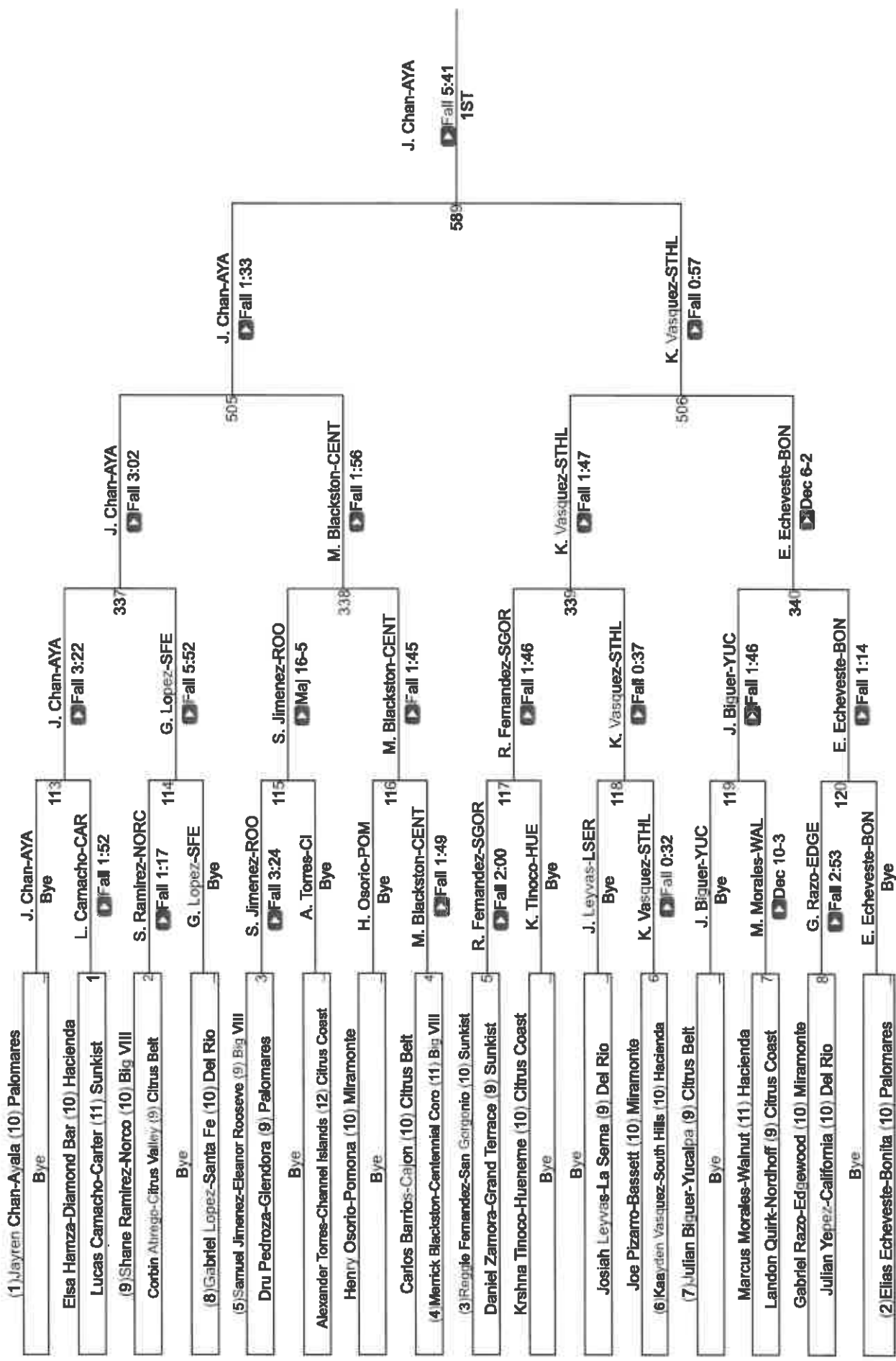

CIF Qualifier 106

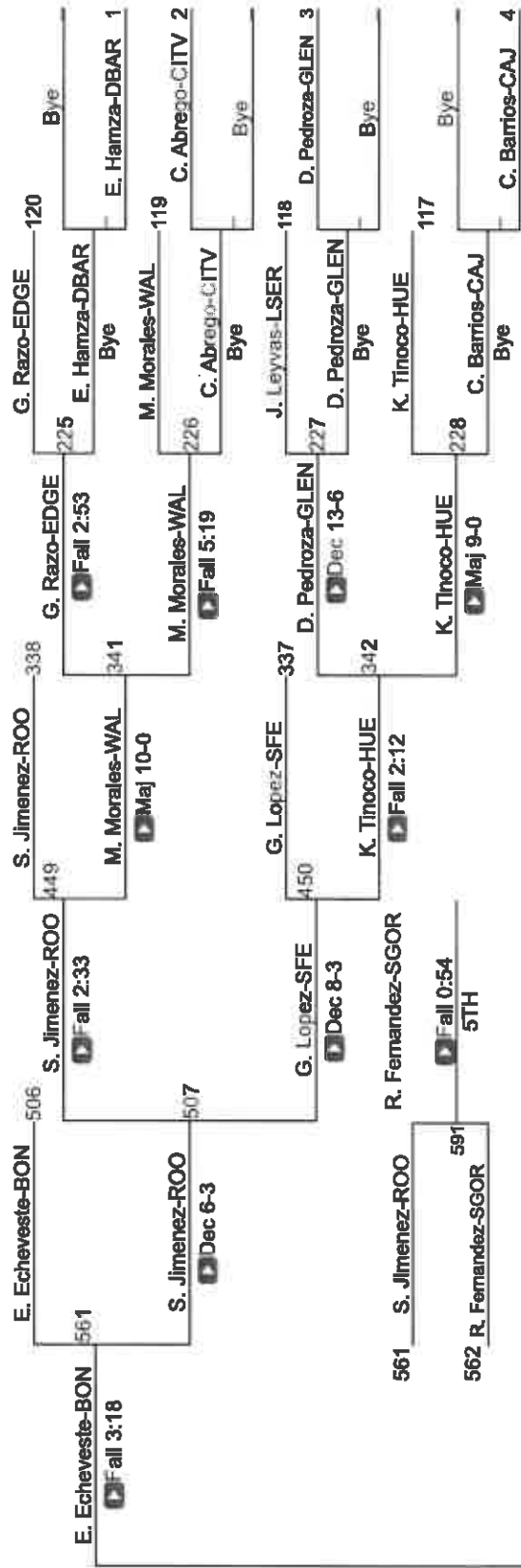

EIF SS Boys Individuals Central Div

EIF Qualifier 113

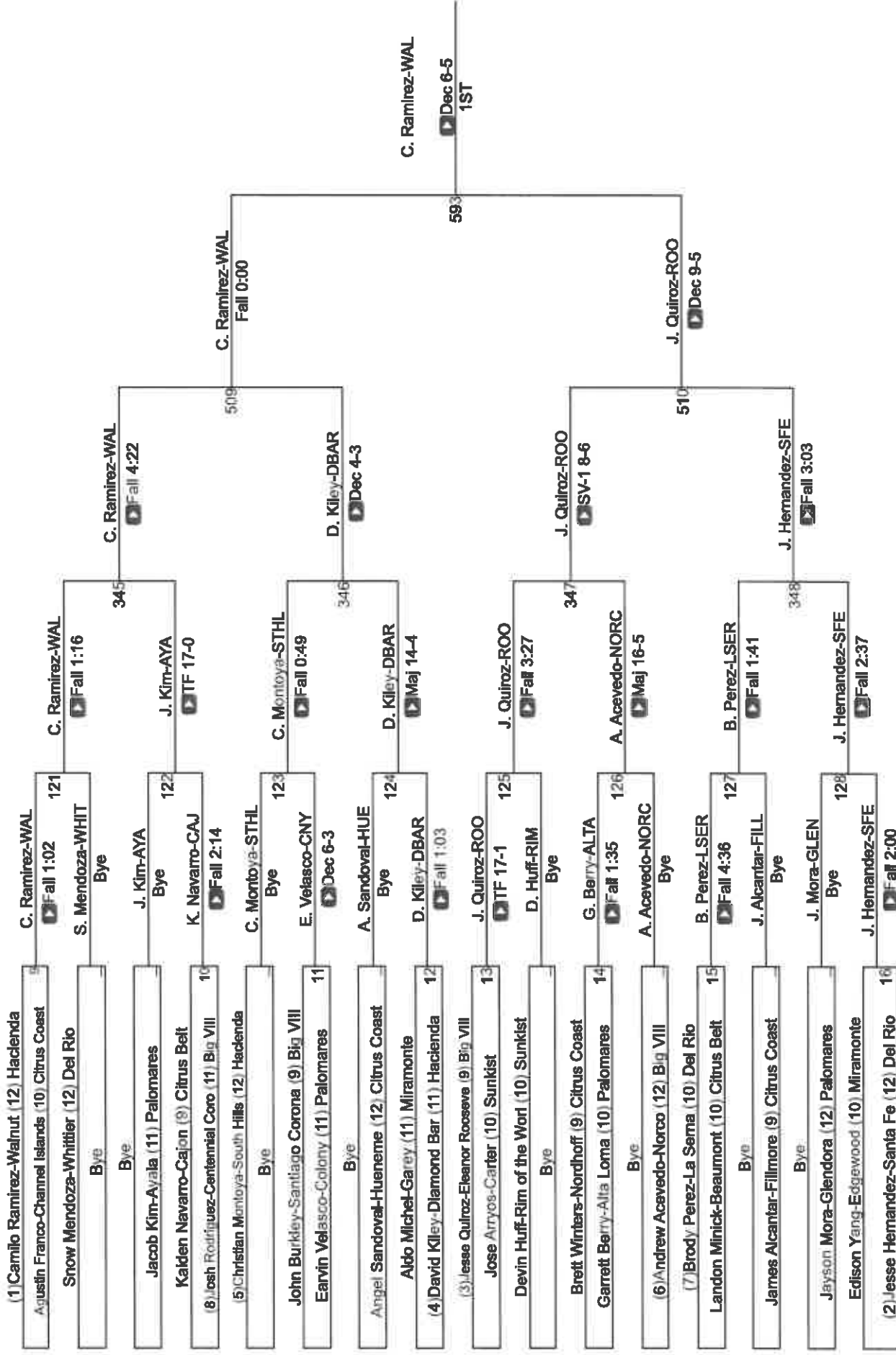

EIF SS Boys Individuals Central Div

EIF Qualifier 120

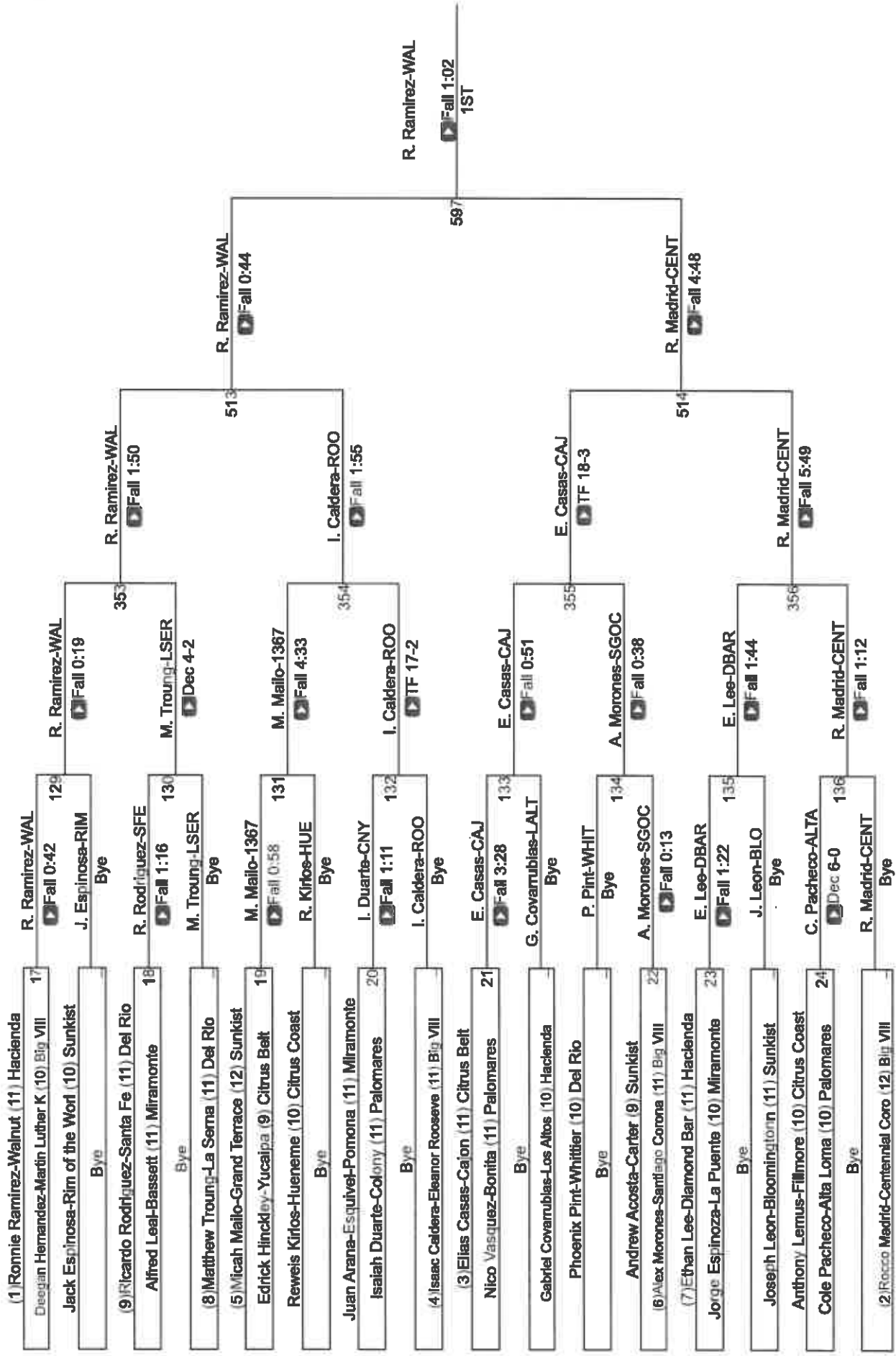

EIF SS Boys Individuals Central Div

EIF Qualifier 126

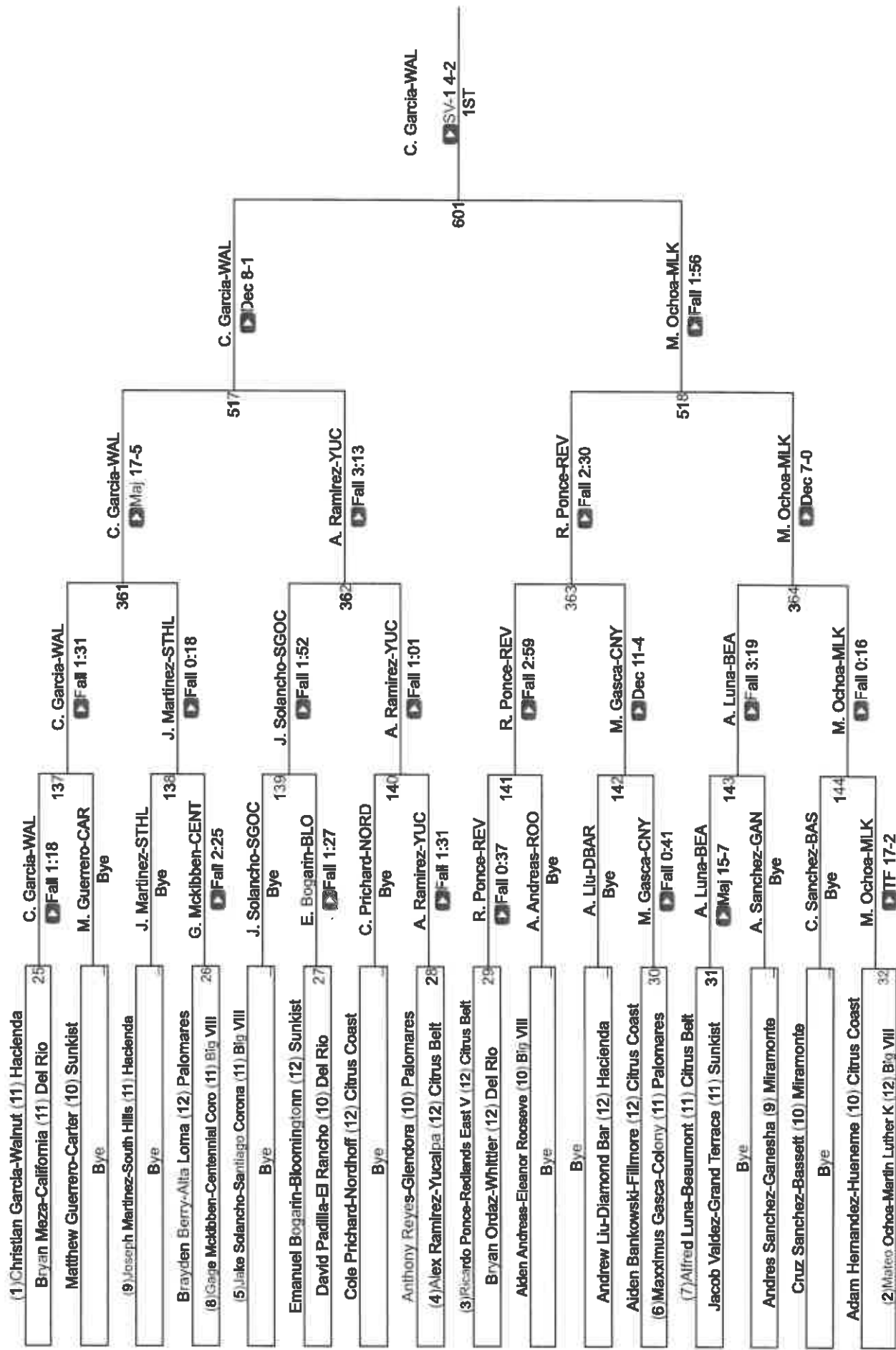

CIF SS Boys Individuals Central Div

CIF Qualifier 132

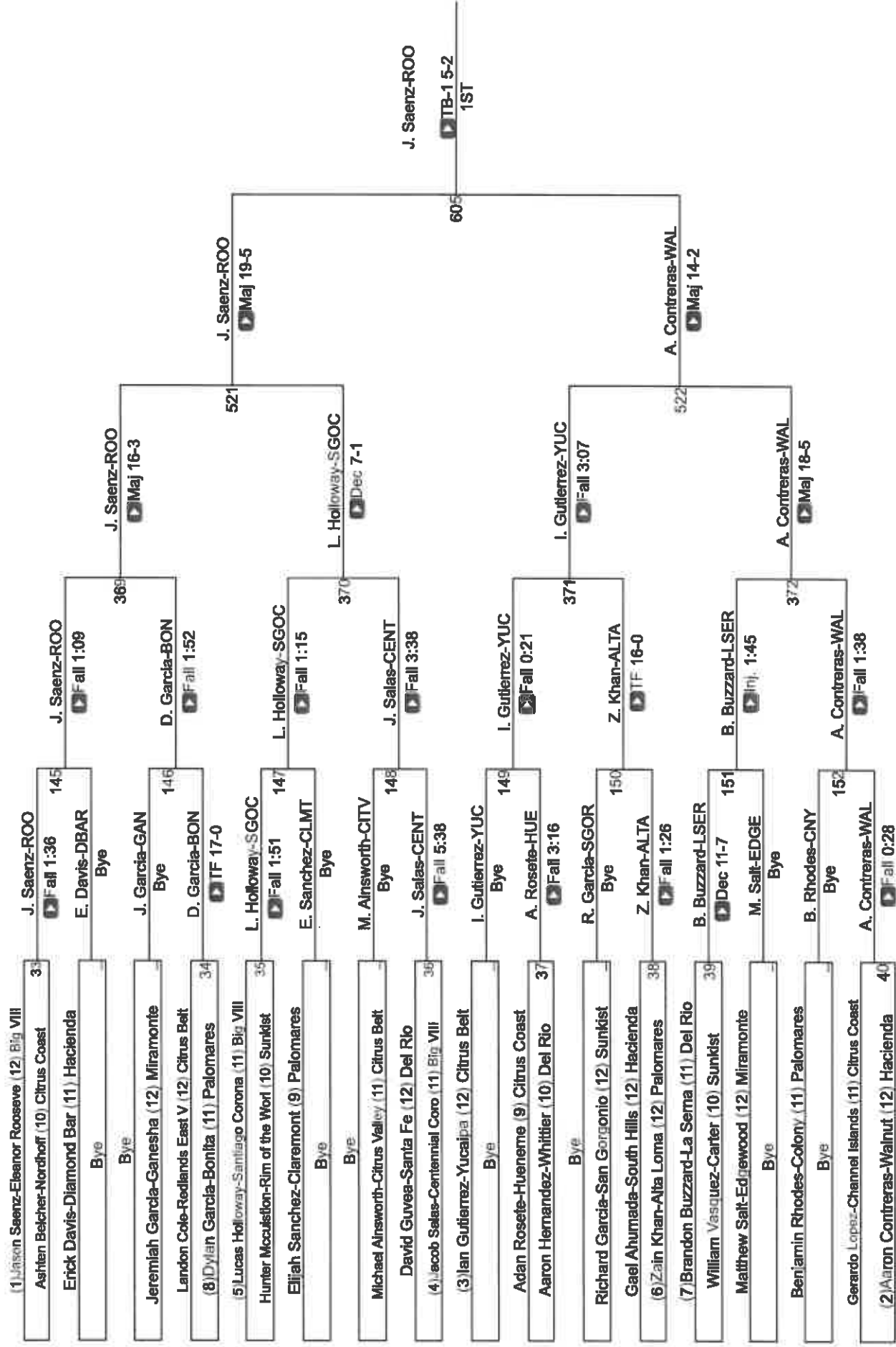

CIF SS Boys Individuals Central Div

CIF Qualifier 138

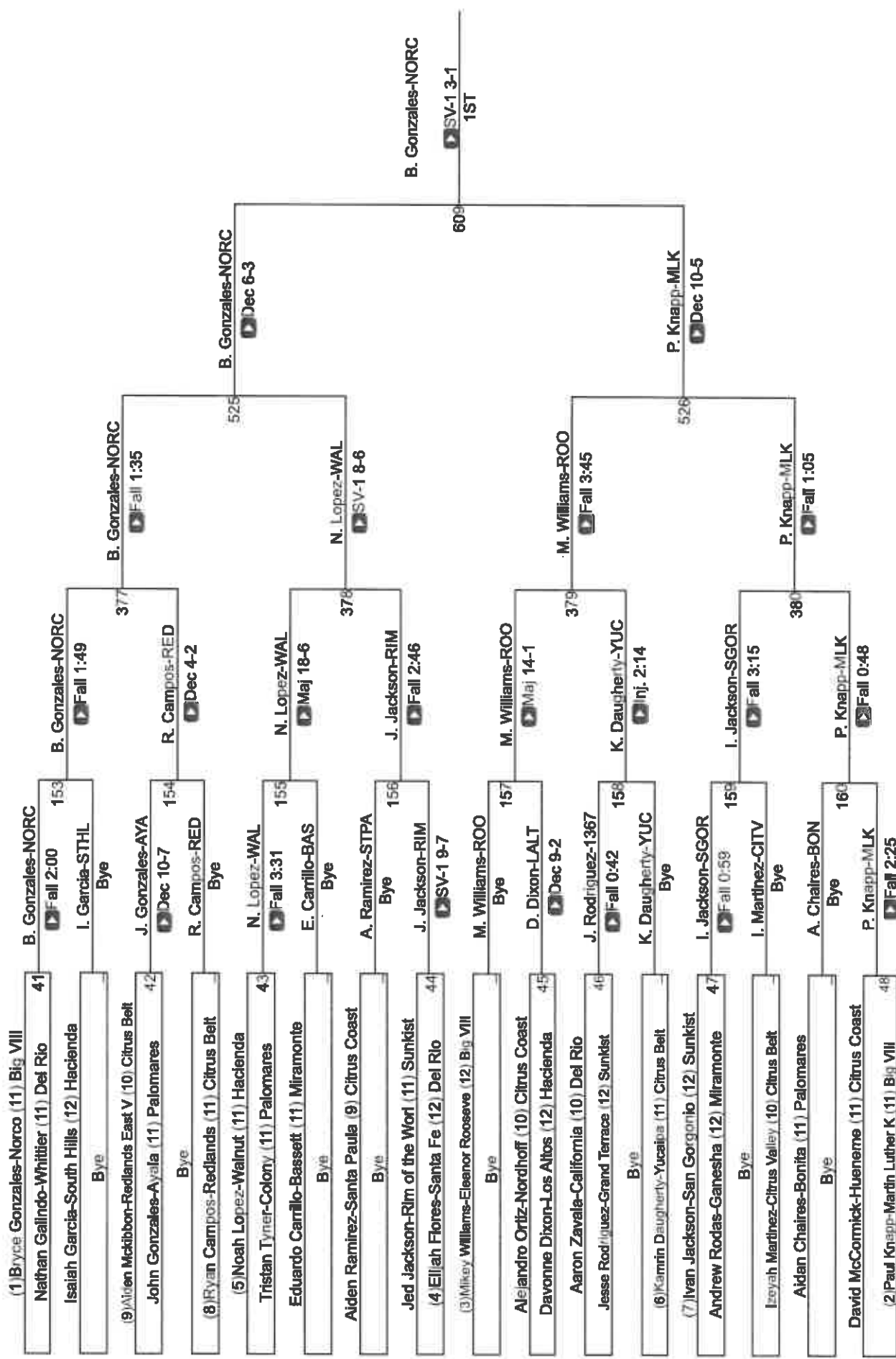

CIF Qualifier 138

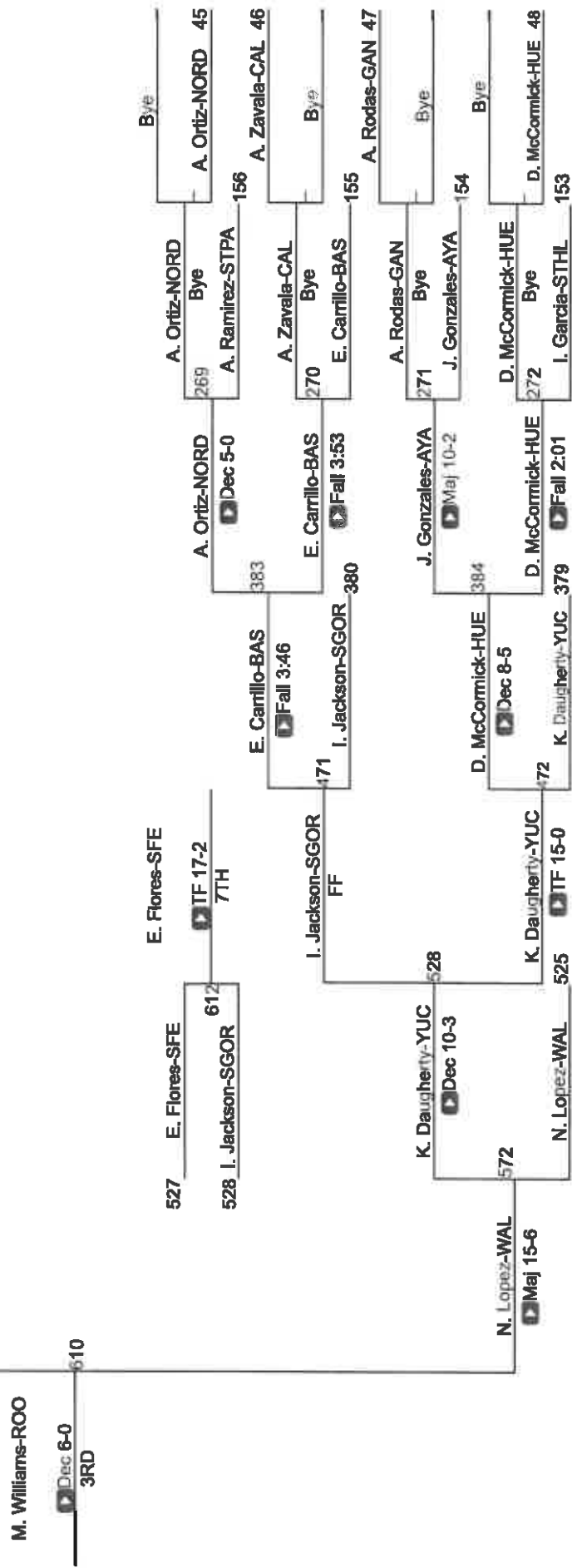
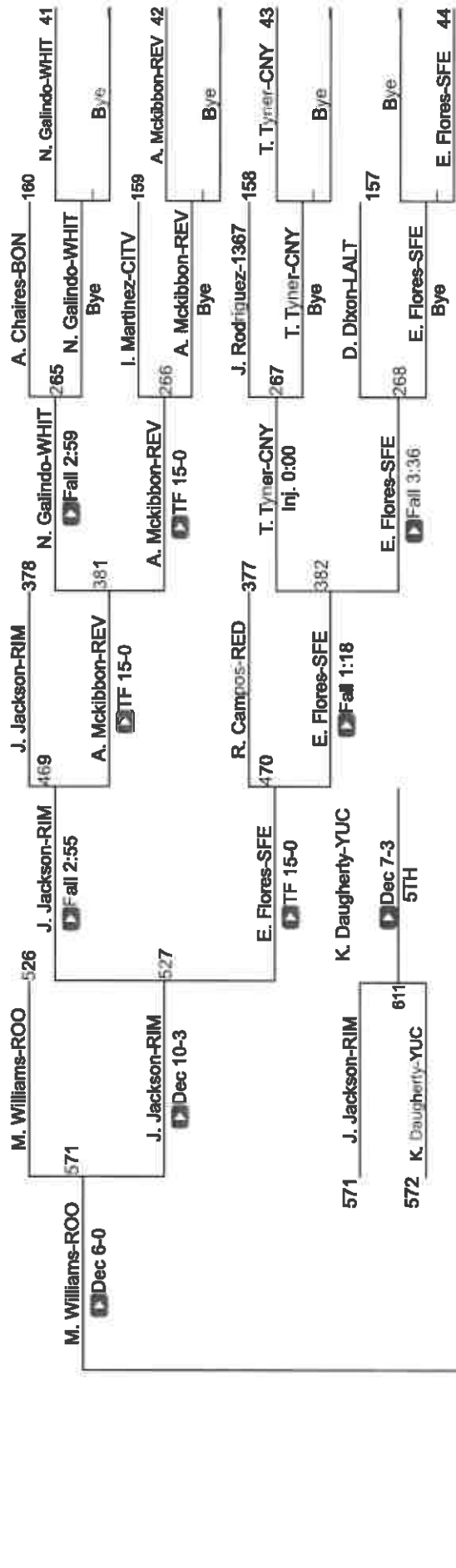

EIF SS Boys Individuals Central Div

EIF Qualifier 144

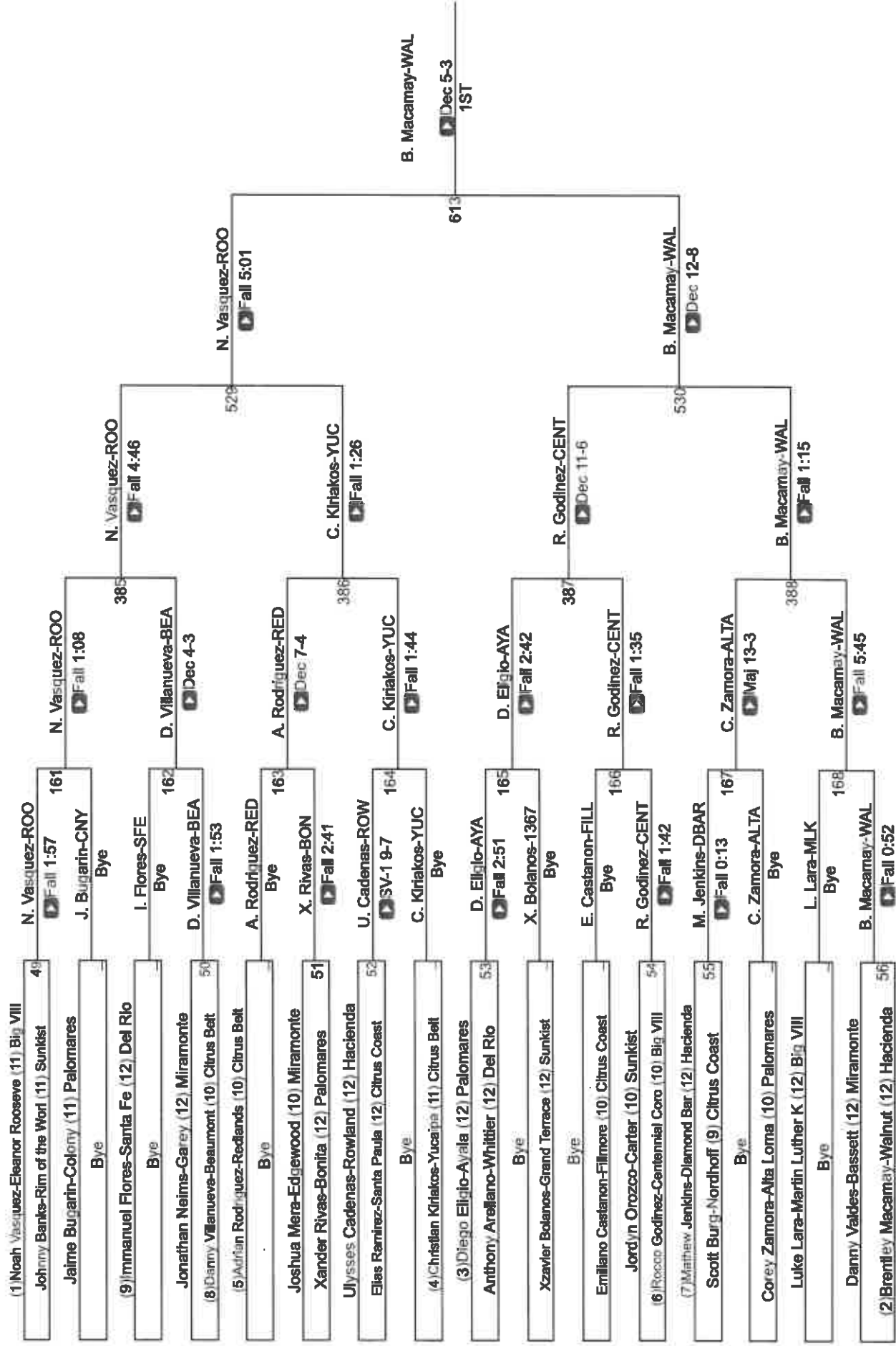

EIF Qualifier 144

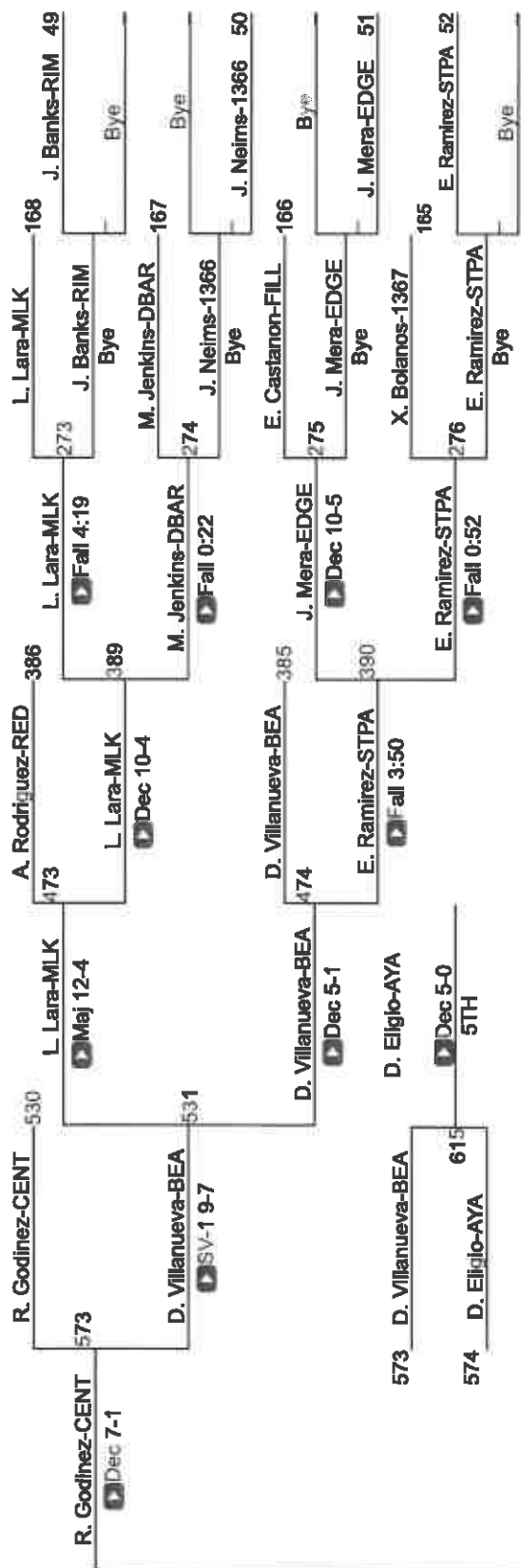

C. Kiriakos-YUC

Fall 0:32
3RD

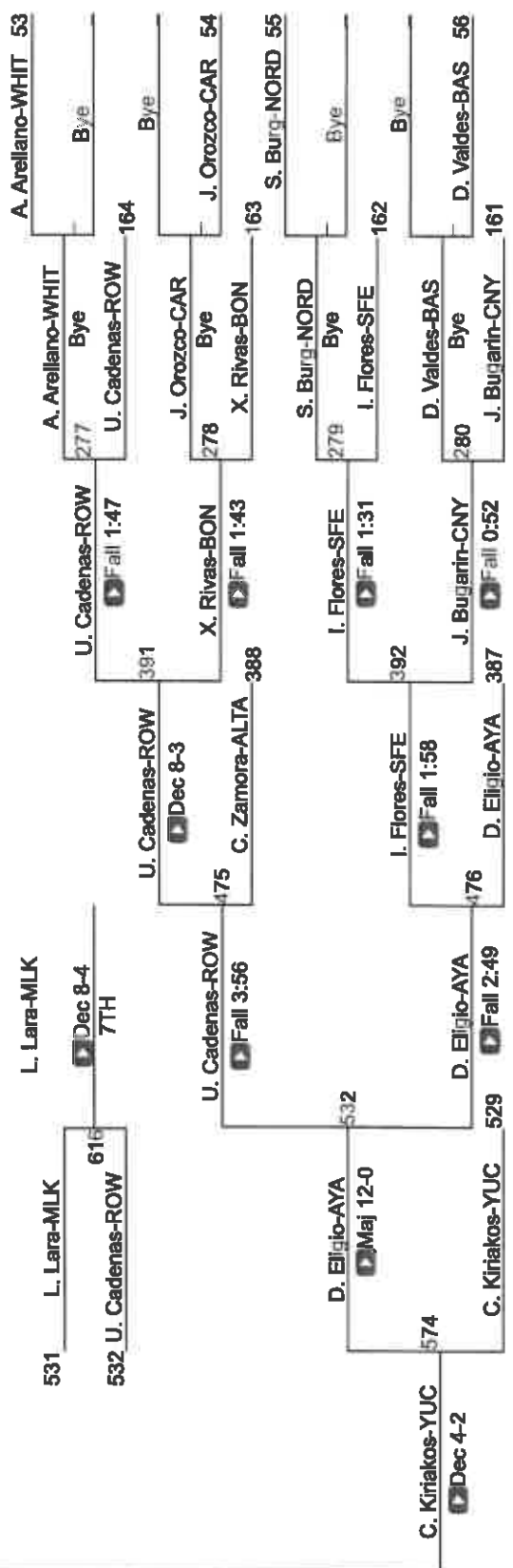

Dec 4-2

EIF SS Boys Individuals Central Div

EIF Qualifier 150

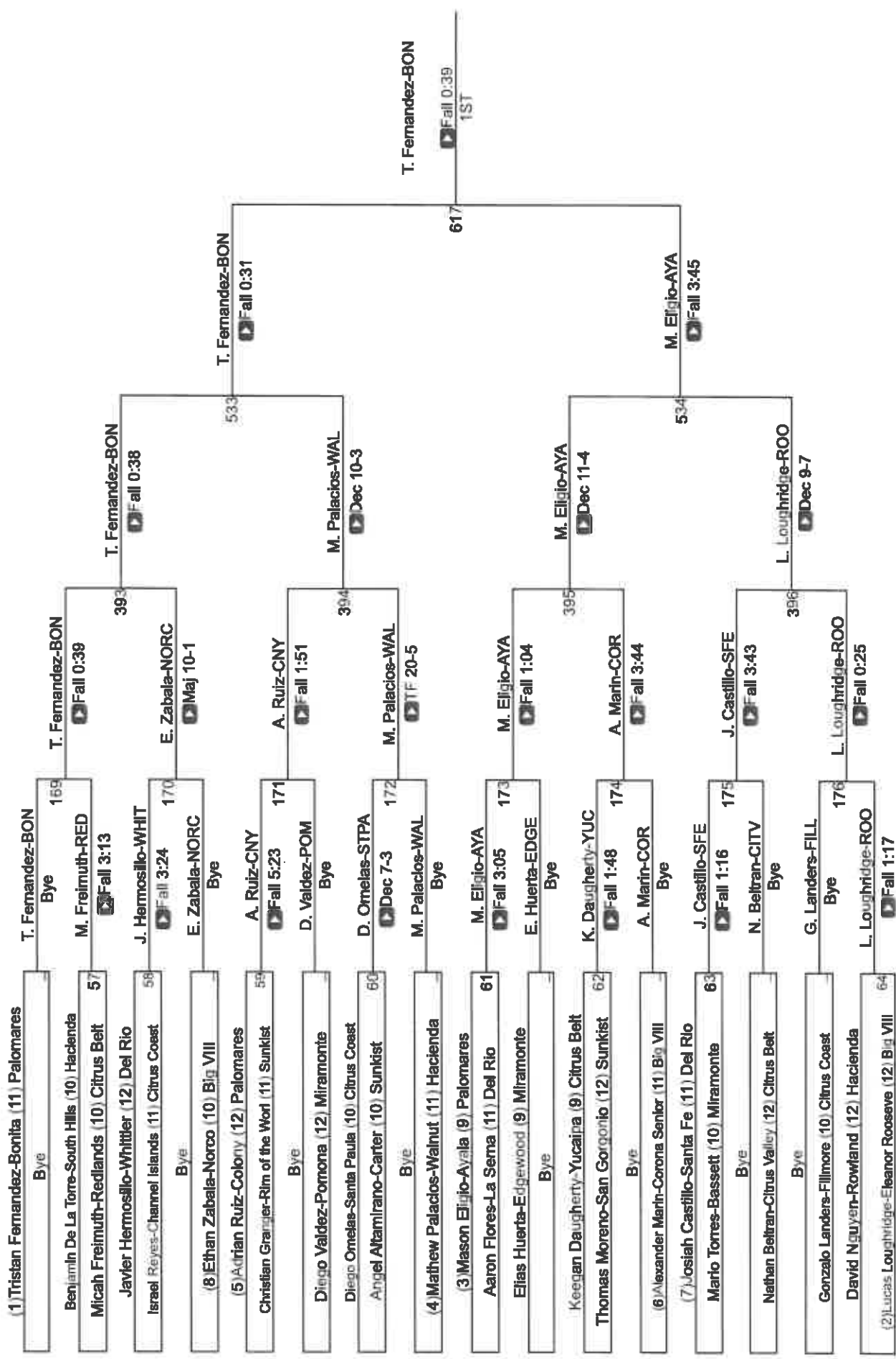

EIF SS Boys Individuals Central Div

EIF Qualifier 157

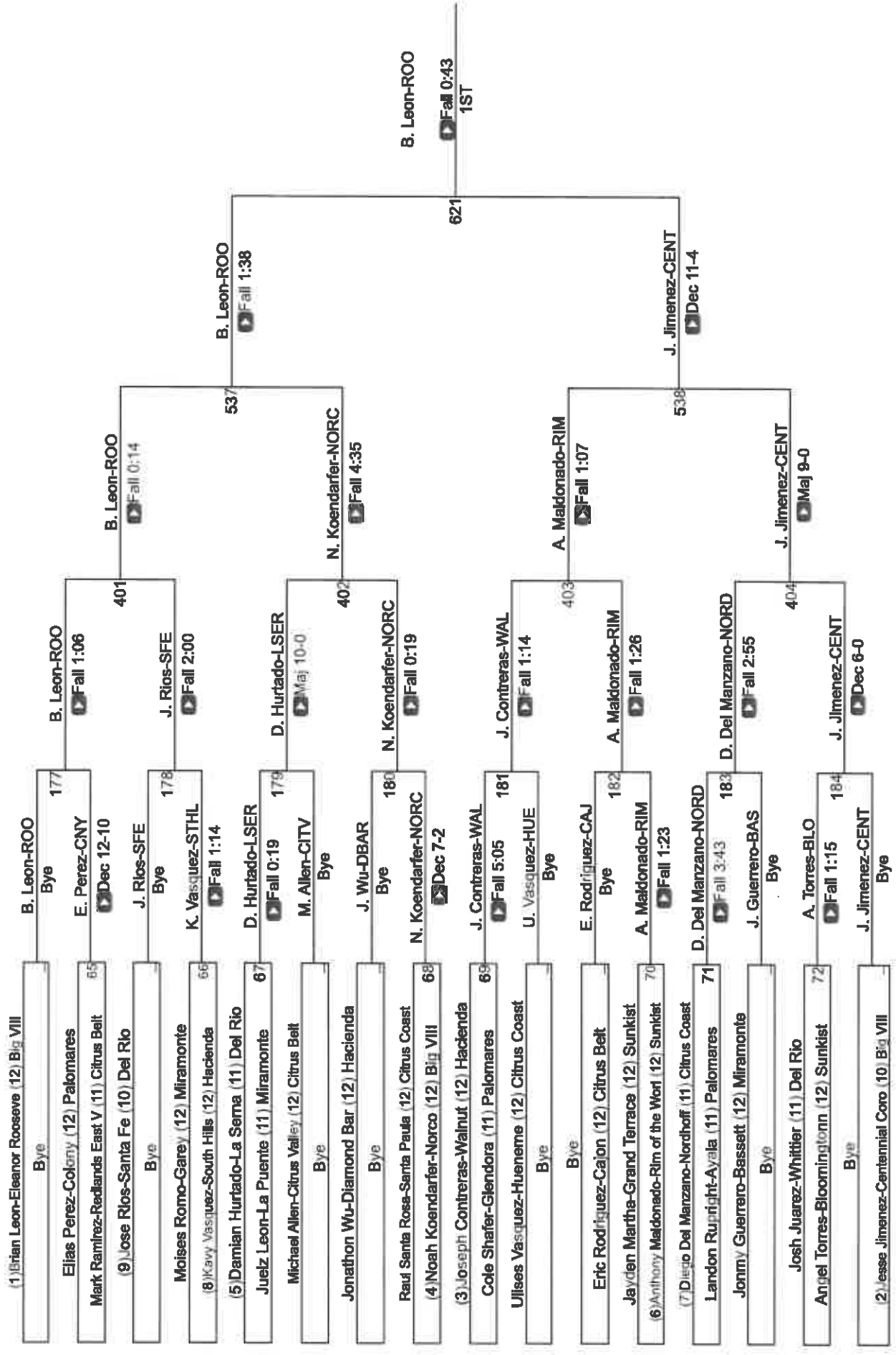

CIF Qualifier 157

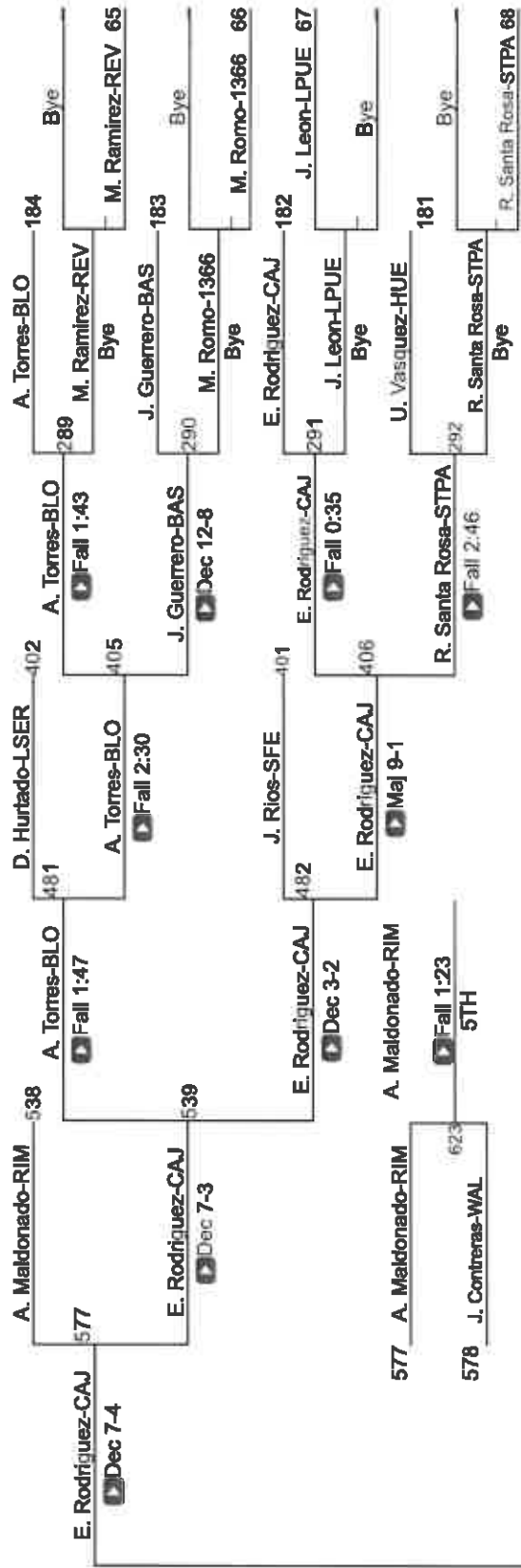

N. Koendarfer-NORC

Fall 0:23
3RD

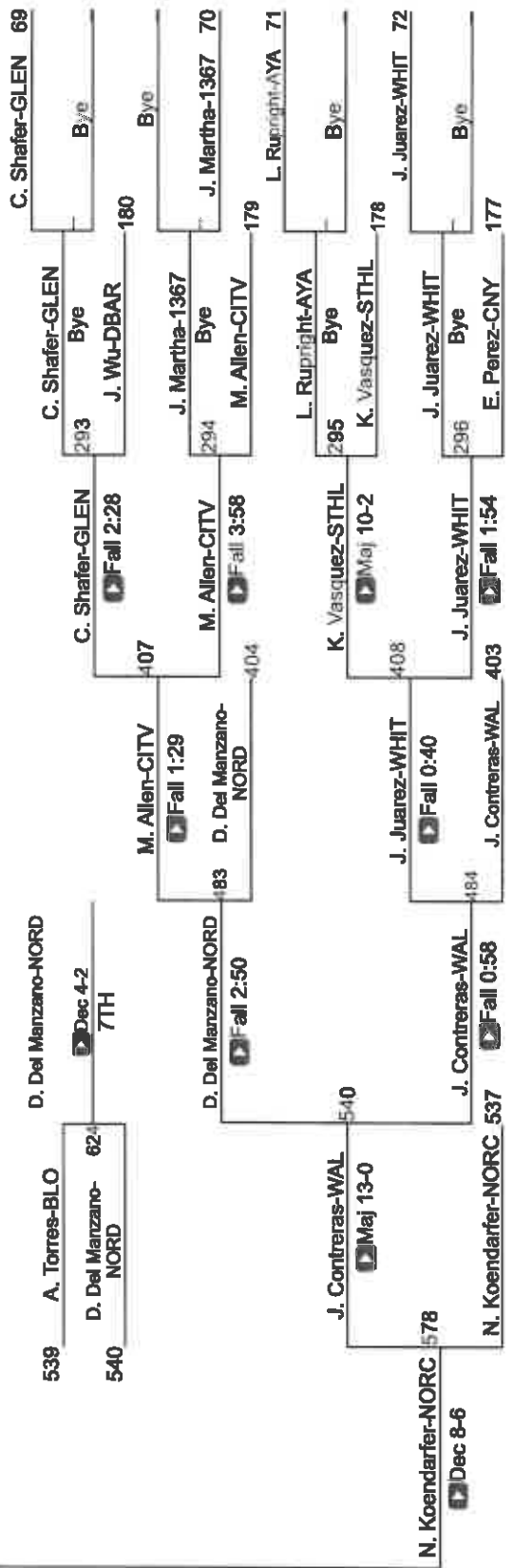

EIF SS Boys Individuals Central Div

EIF Qualifier 165

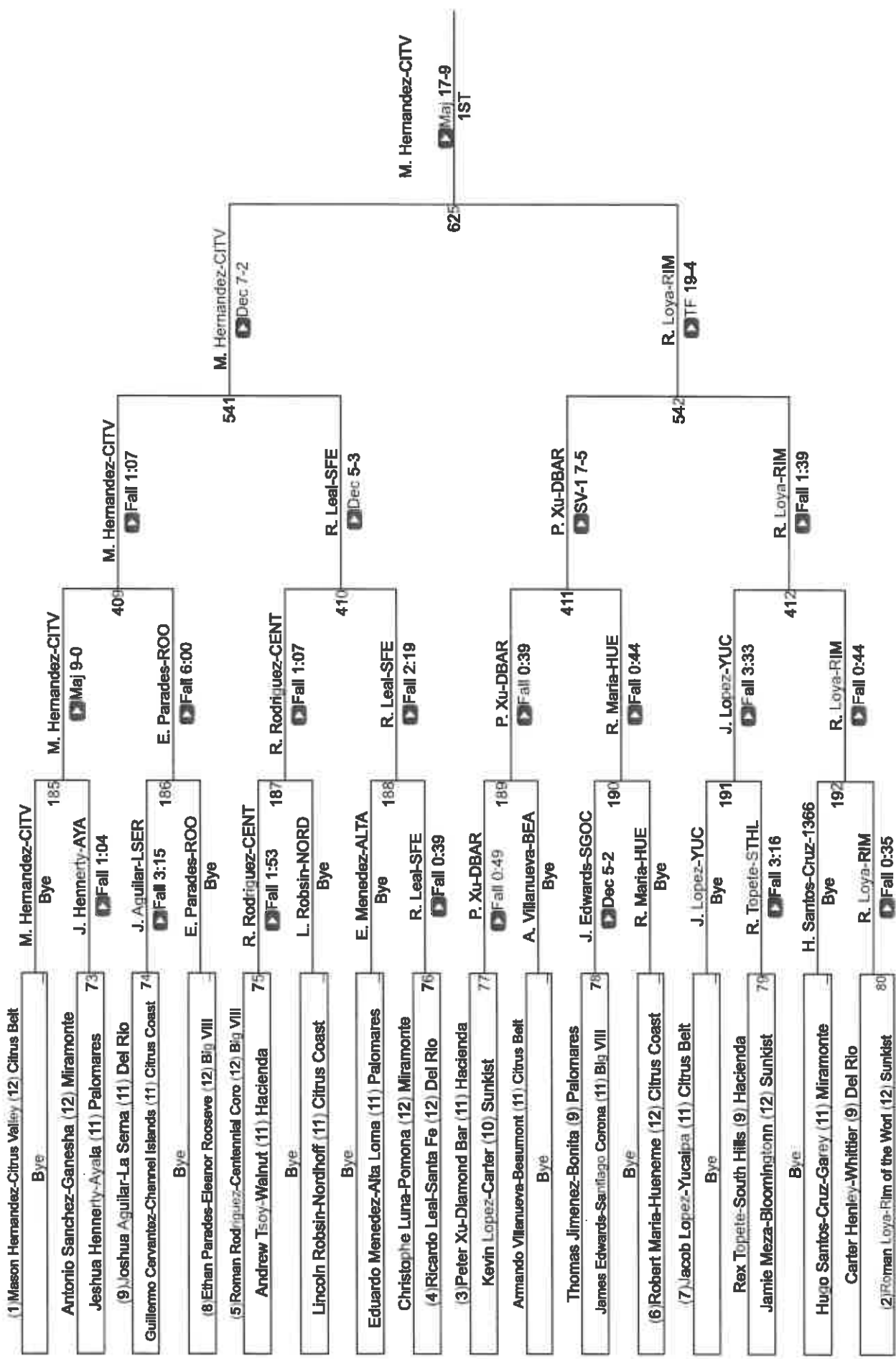

EIF SS Boys Individuals Central Div

EIF Qualifier 175

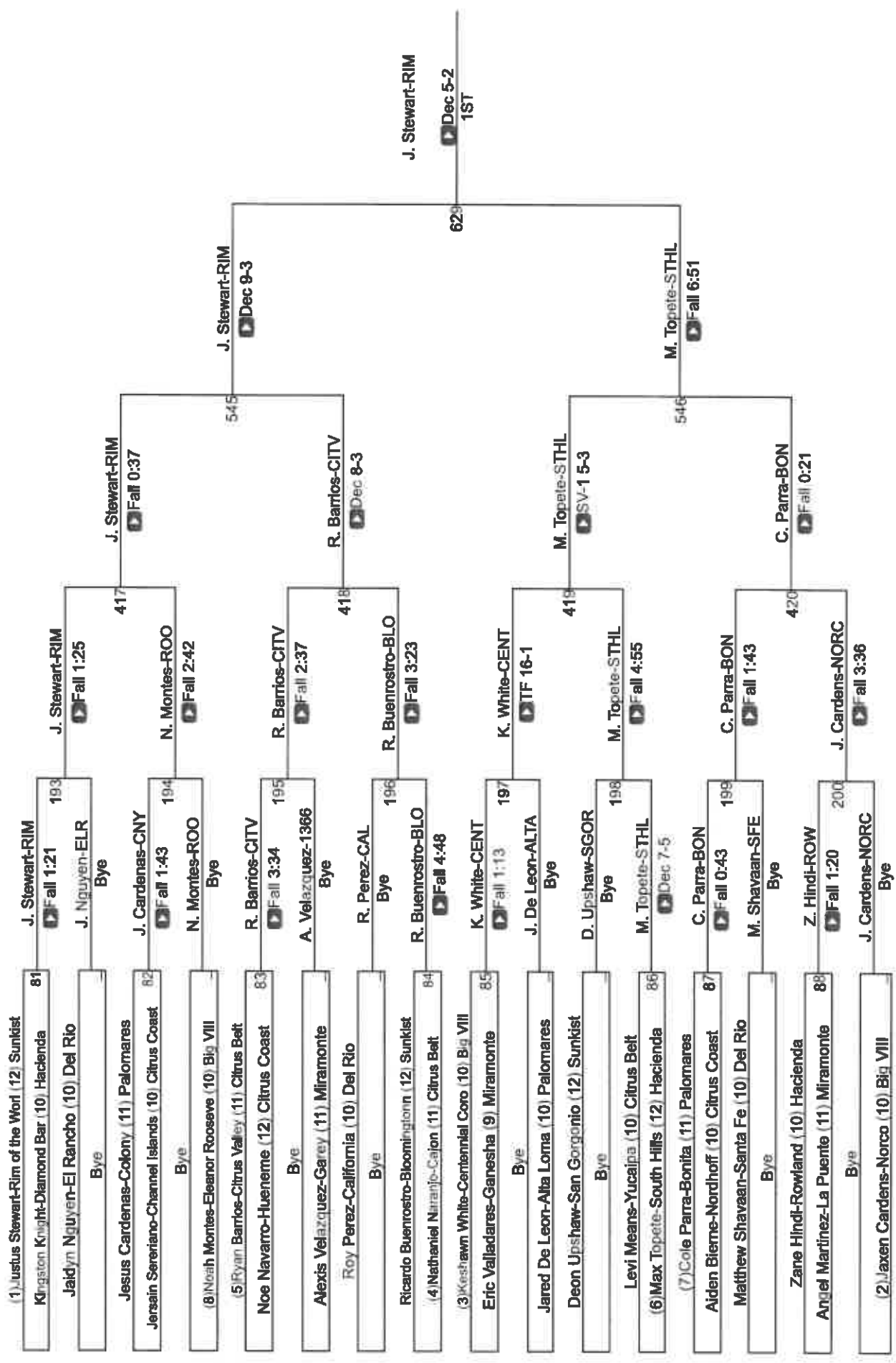

CIF SS Boys Individuals Central Div

CIF Qualifier 190

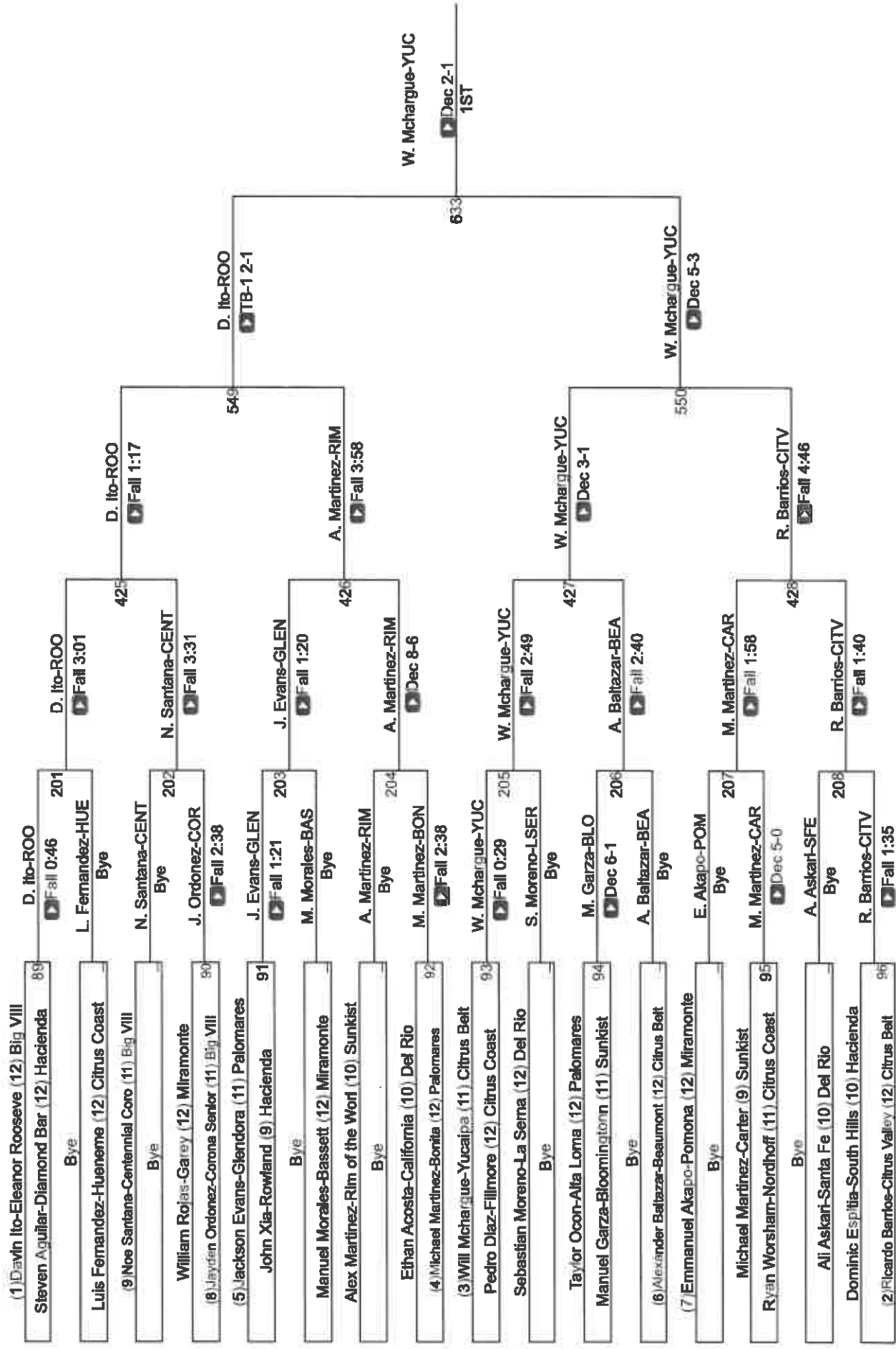

CIF SS Boys Individuals Central Div

CIF Qualifier 215

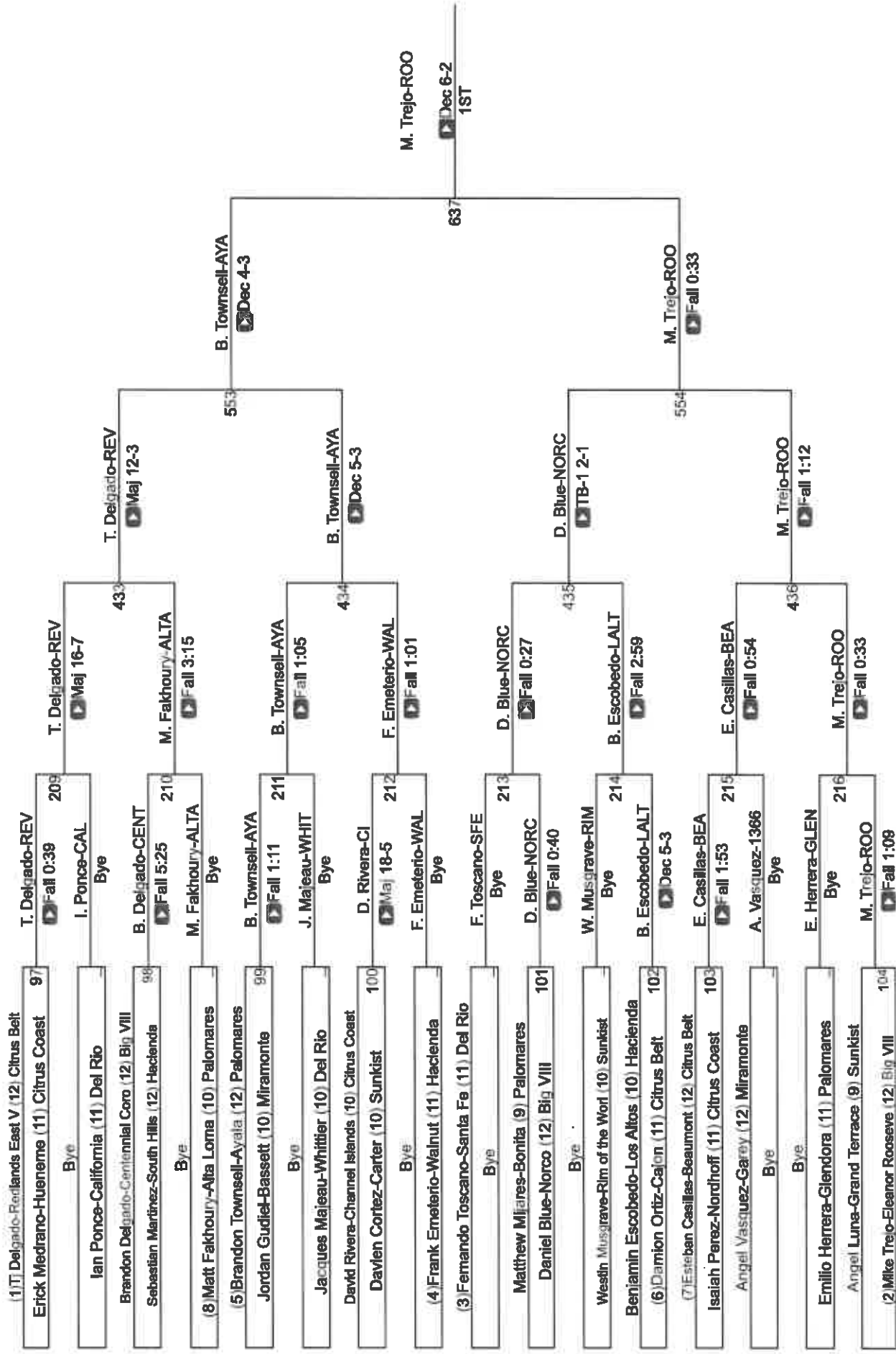

CIF SS Boys Individuals Central Div

CIF Qualifier 285

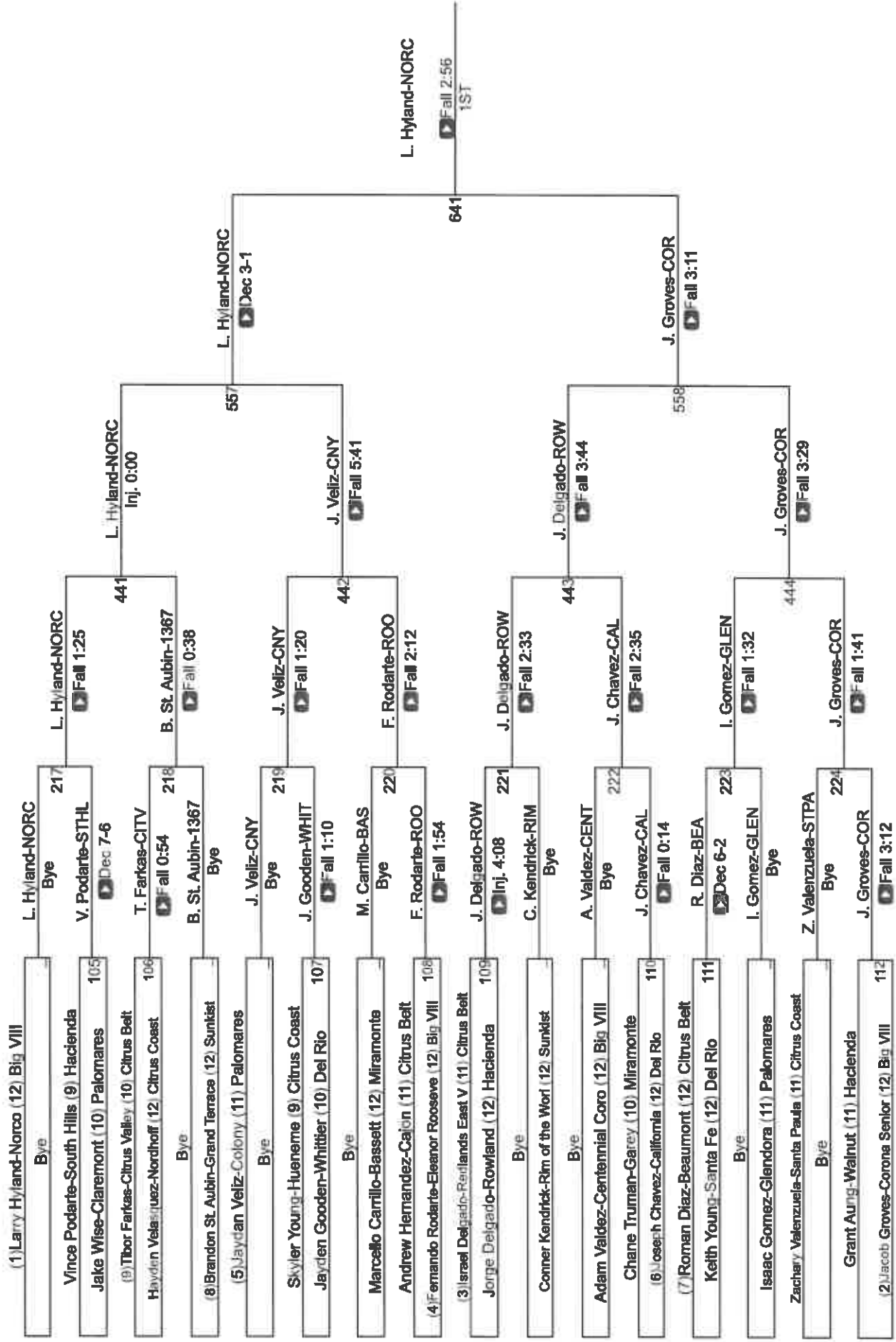

CIF Qualifier 285

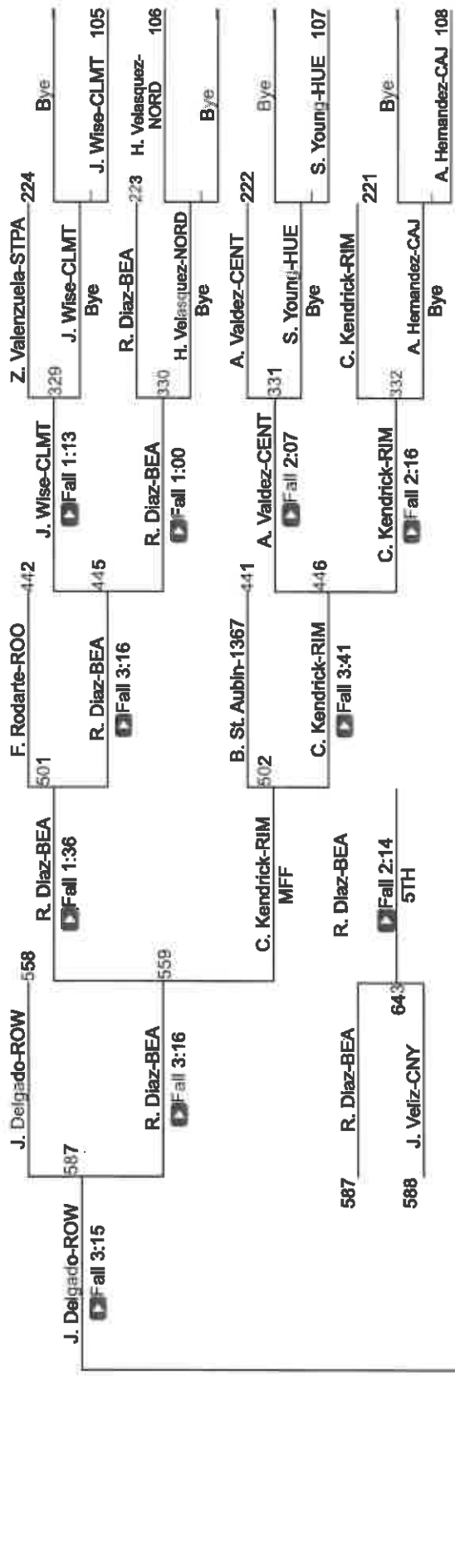

J. Chavez-CAL

Dec 5-2
 3RD

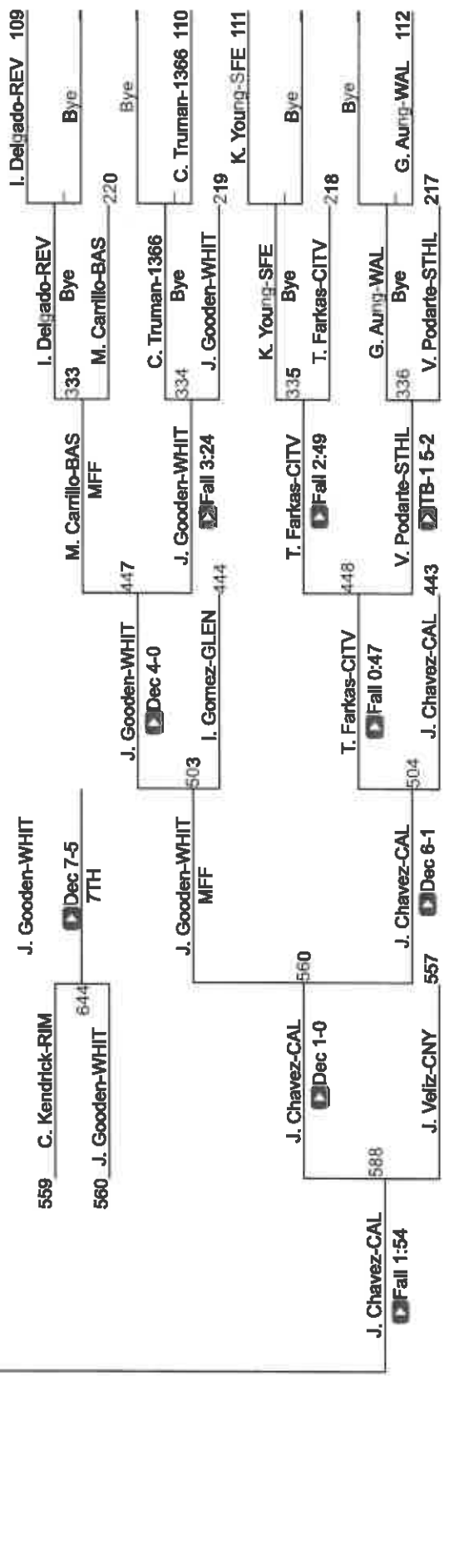

J. Chavez-CAL

Dec 5-2
 3RD

CIF SS Boys Individuals

Coastal Division

Westminster High School

February 9-10, 2024



Lower Weight MVP

Nathan Carrillo
St John Bosco
120 Pounds

Upper Weight MVP

Grigor Cholakyan
St John Bosco
157 Pounds

Placers

108 Pounds		
1st	Zachary Samano	Chino
2nd	Marcus Tolentino	Northview
3rd	Zaka Guerrero	Quartz Hill
4th	Aaron Contreras	West Covina
5th	Matt Hernandez	Rio Mesa
6th	Jason Ybarra	Pacifico Oxnard
7th	Brayden O'Neill	Mater Dei
8th	Jacob Hernandez	Ventura

160 Pounds		
1st	Mikel David Uyamura	San Marino
2nd	Yazir Tellez	St John Bosco
3rd	Michael Schrader	Ventura
4th	Adrian Harris	Highland
5th	Caden Camacho	Servite
6th	Miguel Moreno	Rio Mesa
7th	Cesar Navarro	Agoura
8th	Andrew Ferreyra	Westminster

Team Score Final	
1	St John Bosco 335.5
2	Northview 217.5
3	Servite 212
4	Chino 211
5	Ventura 147
6	Quartz Hill 125
7	Highland 115
8	San Marino 106.5
9	Westminster 95.5
10	Thousand Oaks 70
11	Rio Mesa 68
12	La Canada 67.5
13	Dos Pueblos 64
14	Buena 62
15	Seegerstrom 52
16	Pacifico Oxnard 60
17	Mater Dei 47
18	San Dimas 44.5
19	Garden Grove 44
20	Oxnard 43
21	Montclair 42
22	Burbank 41
23	Lutheran Orange 41
24	Lancaster 35.5
25	Newbury Park 32
26	Godinez 31.5
27	Calabasas 31
28	West Covina 30
29	Little Rock 27
30	Santa Margarita 27
31	Covina 25.5
32	San Marcos 25
33	Ocean View 24
34	Eastside 23.5
35	Monrovia 20
36	Agoura 16
37	Charter Oak 16
38	JSerra 15
39	Westlake 14
40	Ontario 13
41	Hoover 12
42	Knight 12
43	Palmdale 11
44	Santa Barbara 11
45	Diamond Ranch 10
46	Village Christian 9
47	Chaffey 8
48	Katella 8
49	Baldwin Park 4
50	Don Lugo 2

113 Pounds		
1st	Sean Willcox	St John Bosco
2nd	Jovanni Evangelista	Northview
3rd	Isaac Antunez	Godinez
4th	Angel Rivera	San Marcos
5th	Caleb Valenzuela	Chino
6th	Daniel Godinez	Rio Mesa
7th	Andrew Aguilera	Highland
8th	Brayden Beckinger	Quartz Hill

157 Pounds		
1st	Grigor Cholakyan	St John Bosco
2nd	Robert Alanis	Servite
3rd	Cesar Lopez	Highland
4th	Nathaniel Dominguez	Pacifico Oxnard
5th	Freddy Suri	Montclair
6th	David Lopez	Buena
7th	Shane Linehan	Santa Margarita
8th	Noel Munoz	Oxnard

120 Pounds		
1st	Nathan Carrillo	St John Bosco
2nd	Jonathan Madera	Chino
3rd	Michael Manzano	La Canada
4th	Micah Wegman	Calabasas
5th	Noah Butler	Northview
6th	Richard Ma	San Marino
7th	Jayden Tate	Ventura
8th	Gustavo Pulido	Eastside

165 Pounds		
1st	Joseph Antonio	St John Bosco
2nd	Wyde Brant	Ventura
3rd	Christian Berroso	Seegerstrom
4th	Samuel Ramos	Dos Pueblos
5th	Ethan Cedillo	Westminster
6th	Manuel Quesada	Oxnard
7th	Luke Hankins	Servite
8th	Luis Catalan	Chaffey

126 Pounds		
1st	Michael Romero	St John Bosco
2nd	Ryan Pedroza	Buena
3rd	Jaime Serrato	Highland
4th	Elise Flores	Northview
5th	Alex Newman	Servite
6th	Noah Halstead	Lancaster
7th	Daniel Beeza	San Dimas
8th	Jesse Salazar	Covina

175 Pounds		
1st	Michael Vasalle	Chino
2nd	Evan Sepanlou	Quartz Hill
3rd	Michael Alvarez	Mater Dei
4th	Brayden Carson	St John Bosco
5th	Aiden Pacheco	Northview
6th	Brando Mosqueda	Servite
7th	Maxwell Rosen	La Canada
8th	Grickore Danelyan	Hoover

132 Pounds		
1st	Jesse Grajeda	St John Bosco
2nd	Henry Arellano	Northview
3rd	Calen Reyna	Servite
4th	Shaun Vague	Dos Pueblos
5th	David Franco	Chino
6th	Savak Araklyan	Burbank
7th	Skyler Field	Little Rock
8th	Darius Mello	Thousand Oaks

190 Pounds		
1st	Sonny Acuna	Northview
2nd	Mitchell Semaan	Servite
3rd	Thai Nguyen	Ocean View
4th	Taaman Cassell	Newbury Park
5th	Nathan Blanco	Chino
6th	Tyler Townhill	Quartz Hill
7th	Mike Baeza	San Dimas
8th	Dylan Beatale	La Canada

138 Pounds		
1st	Sergio Gomez	St John Bosco
2nd	Nathan Cauwel	Chino
3rd	Ethan Dorsey	Ventura
4th	Patrick Flores	Westminster
5th	Jacob Owen	Servite
6th	Richard Kalejyan	Burbank
7th	Dylan Kendall	Quartz Hill
8th	Josh Sim	Lutheran Orange

215 Pounds		
1st	James Rocha	Thousand Oaks
2nd	Edwin Hopkins	Westminster
3rd	Jayden Baer	Quartz Hill
4th	Tusfala III	Lutheran Orange
5th	Julian Solis	San Marino
6th	Jorge Alvarez	Ventura
7th	Adam Galindo	Servite
8th	David Perez	Rio Mesa

144 Pounds		
1st	Ryder Yoshitake	San Marino
2nd	Viviano Gutierrez	Northview
3rd	Tigran Greyan	St John Bosco
4th	Joshua Valdez	Servite
5th	Daniel Rundle	Ventura
6th	Kilian Hannegan	JSerra
7th	Maxwell Hoang	Garden Grove
8th	Nathanial Gonzalez	Chino

285 Pounds		
1st	Nicholas Sahakian	St John Bosco
2nd	Sultan Jasem	Highland
3rd	Brandon Bass	Servite
4th	George Llamas	Montclair
5th	Jorge Hernandez	Chino
6th	Alan Snell	Garden Grove
7th	Gabriel Velasco	Northview
8th	Armani Cortez-Castillo	Lancaster

EIF SS Boys Individuals Coastal Div

EIF Qualifier 106

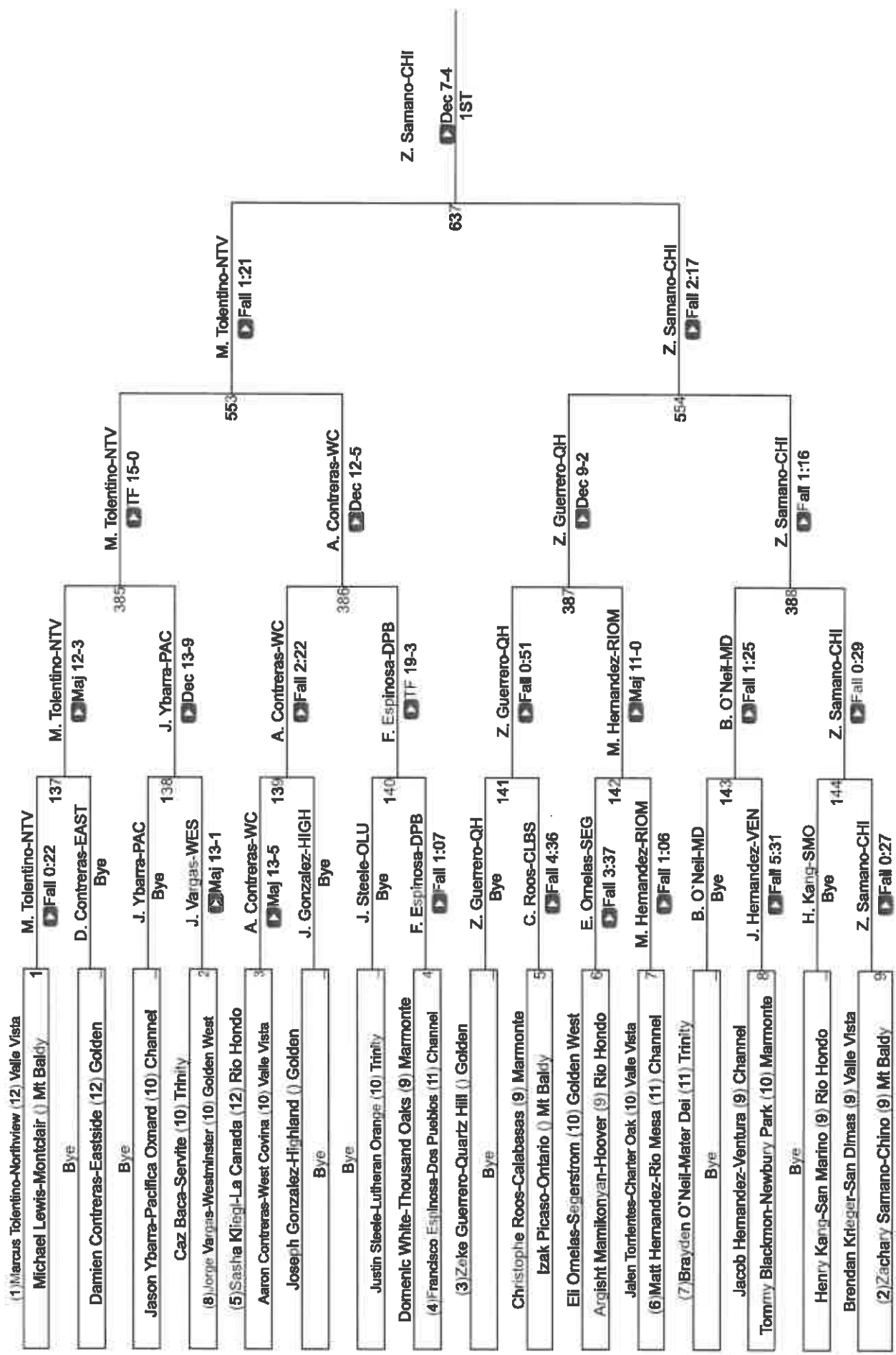

EIF Qualifier 106

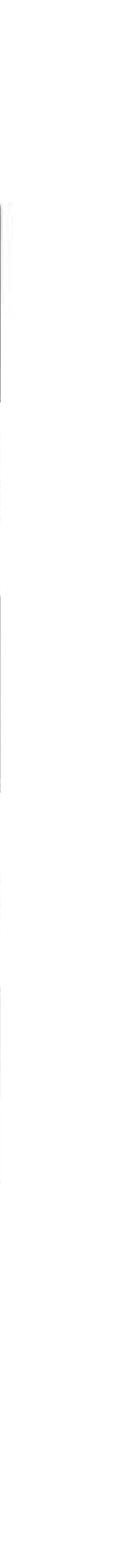
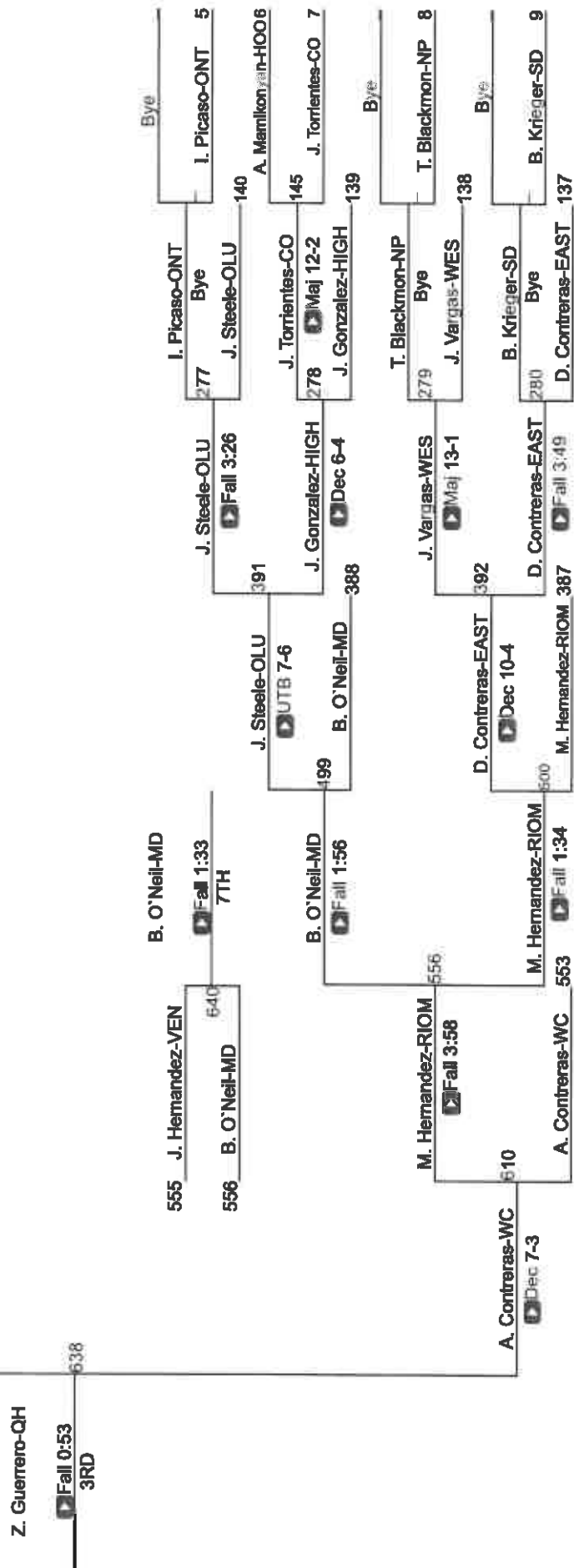
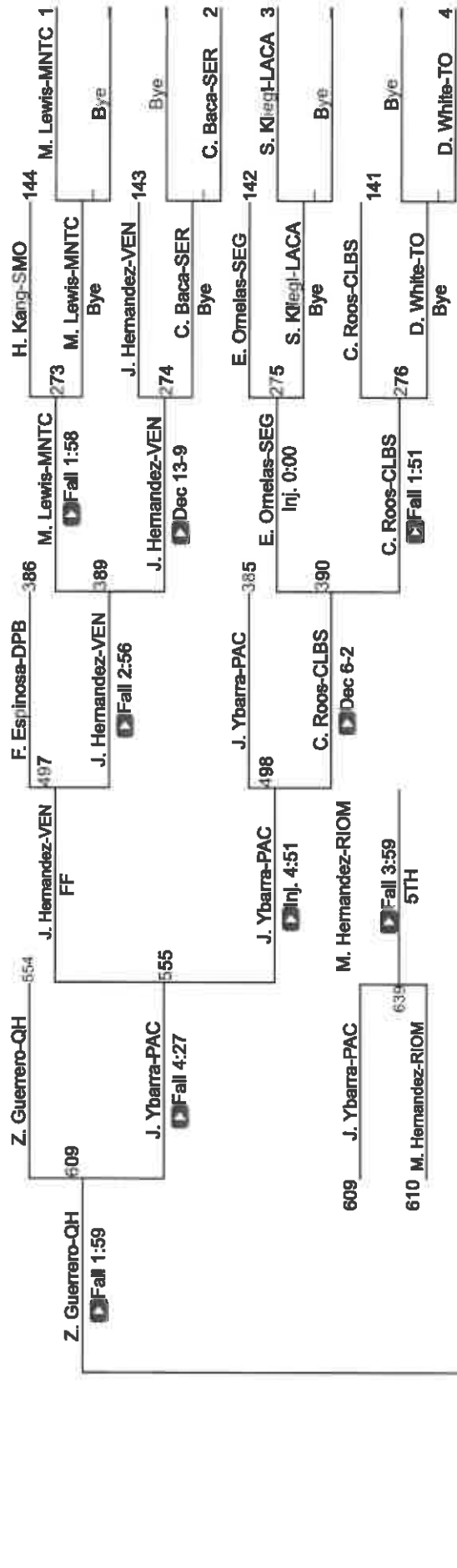

EIF SS Boys Individuals Coastal Div

EIF Qualifier 113

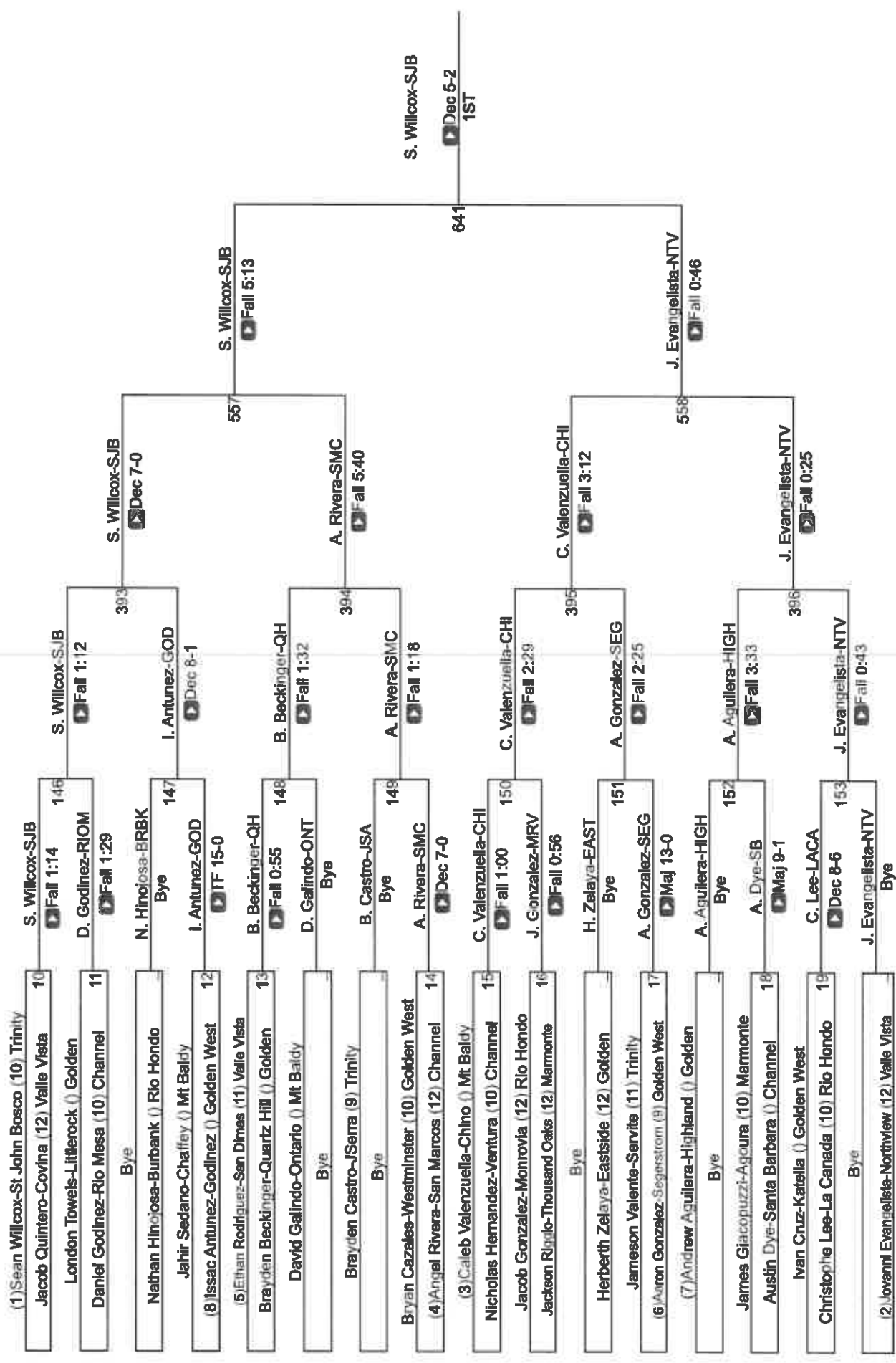

CIF Qualifier 113

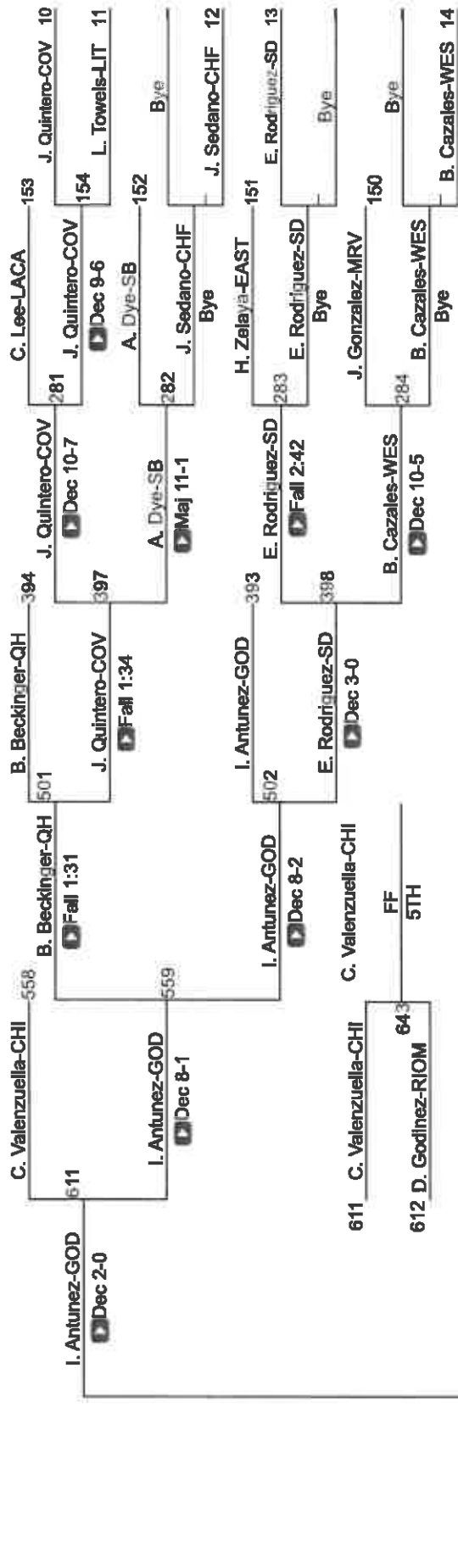

I. Antunez-GOD

SV-1 5-3
3RD

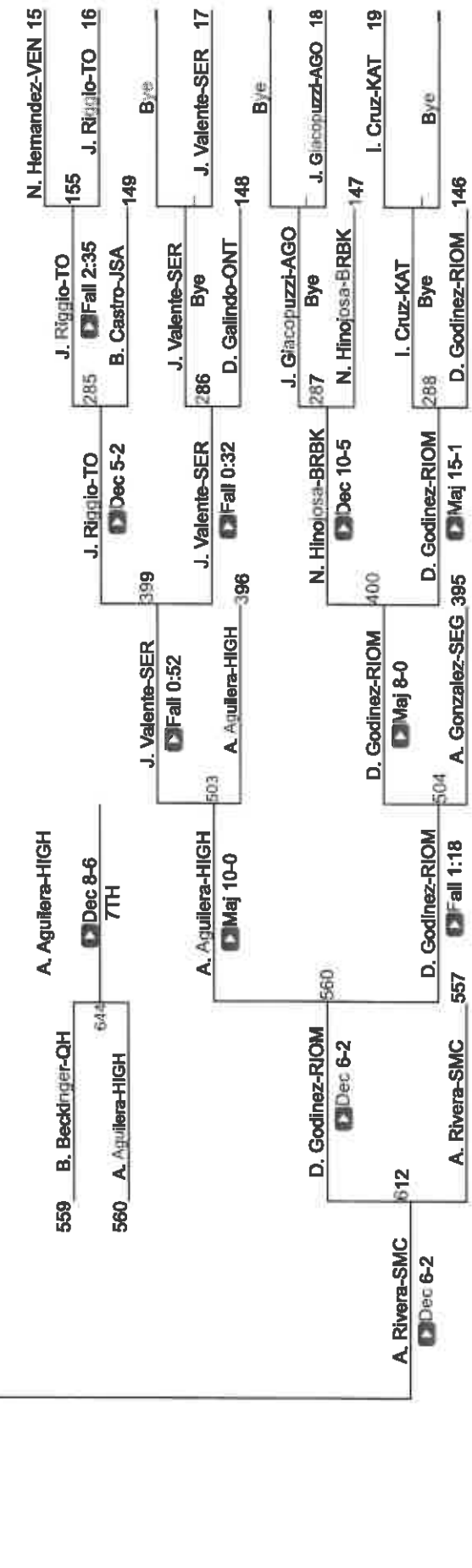

A. Rivera-SMC

EIF SS Boys Individuals Coastal Div

EIF Qualifier 120

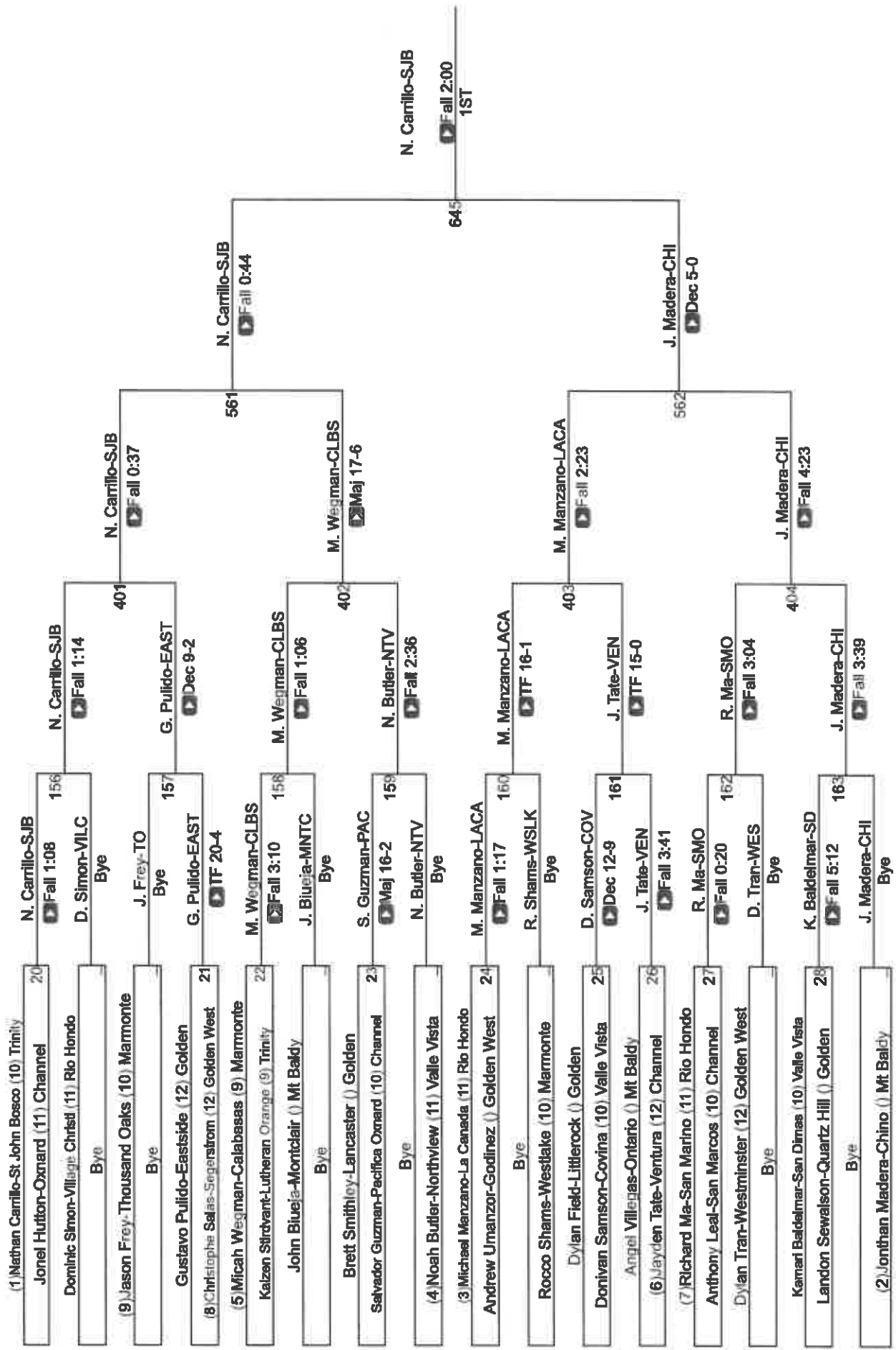

CIF Qualifier 120

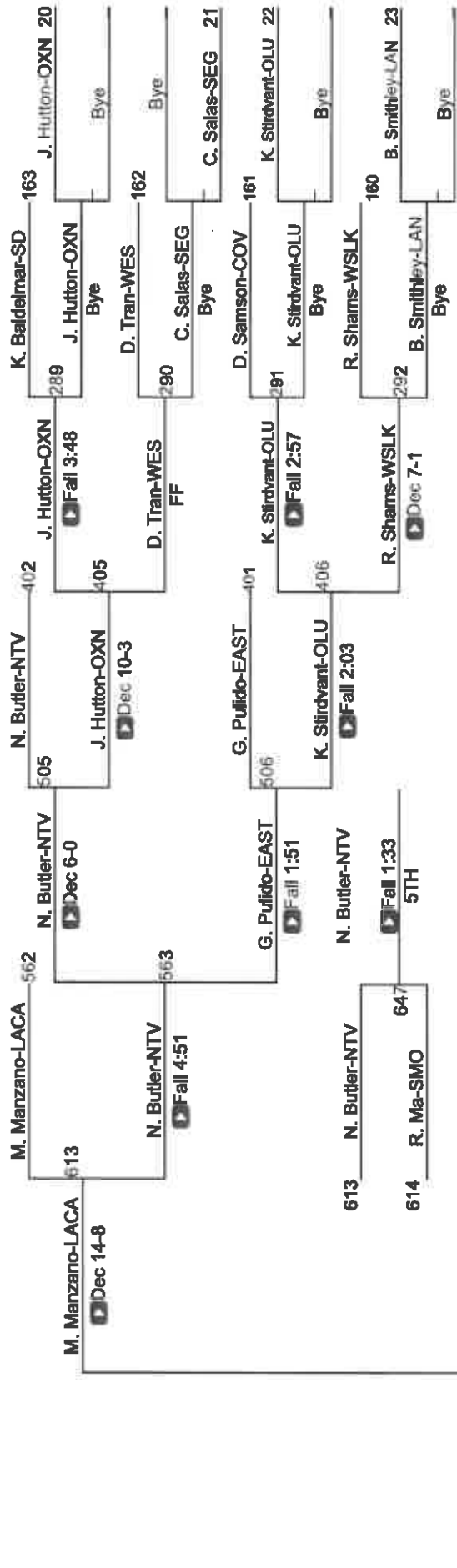

M. Manzano-LACA

Fall 2:26
3RD

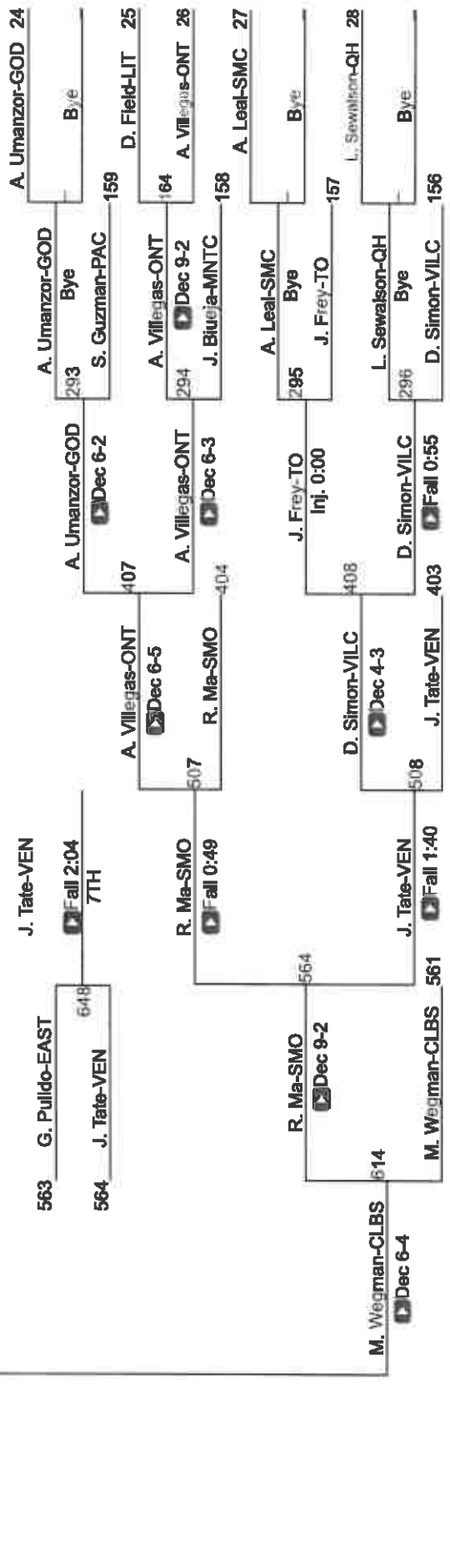

M. Wigman-CLBS

Dec 6-4

EIF SS Boys Individuals Coastal Div

EIF Qualifier 126

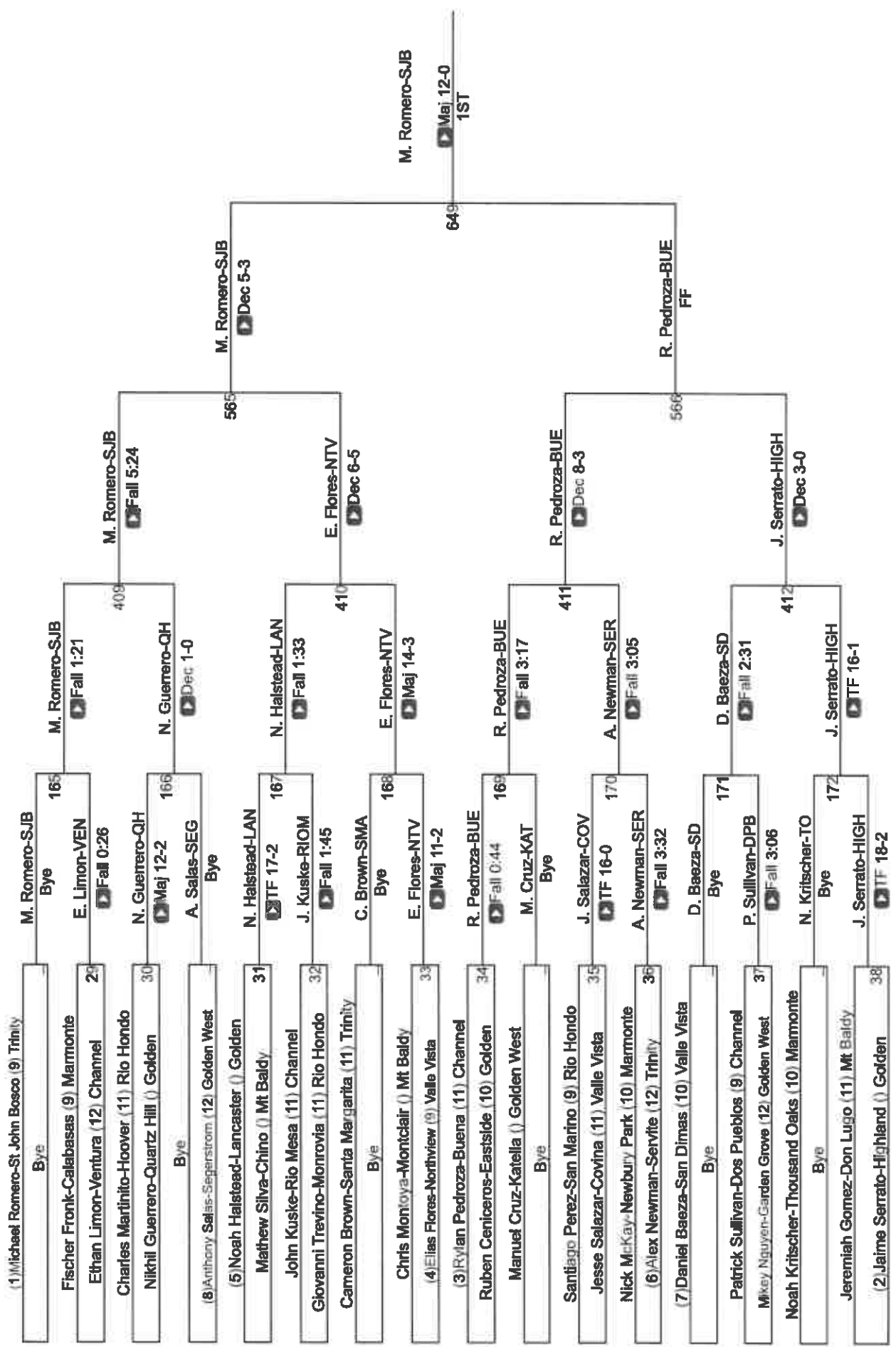

EIF Qualifier #126

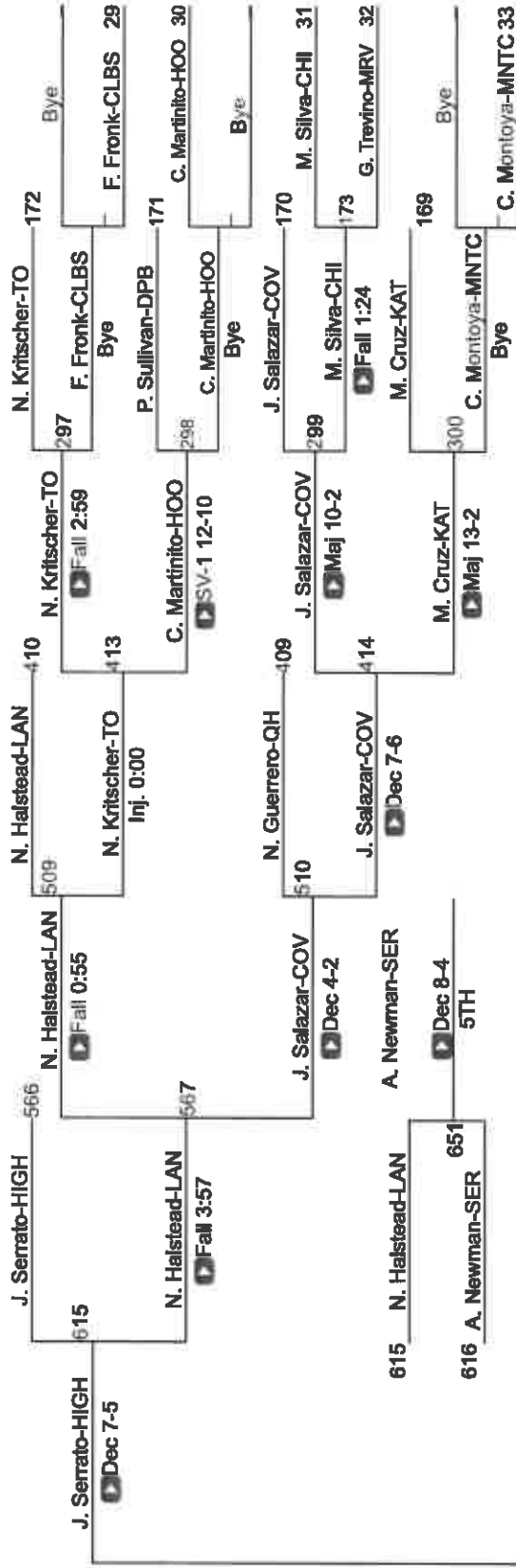

J. Serrato-HIGH

Dec 6-2
3RD

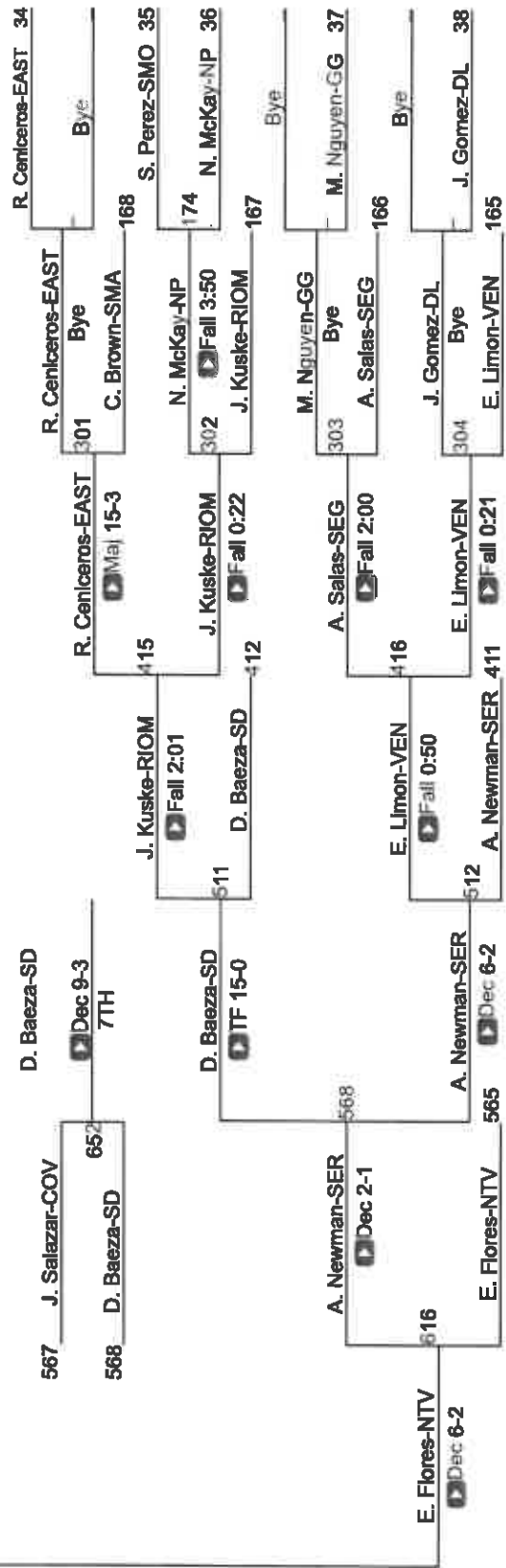

CIF SS Boys Individuals Coastal Div

CIF Qualifier 132

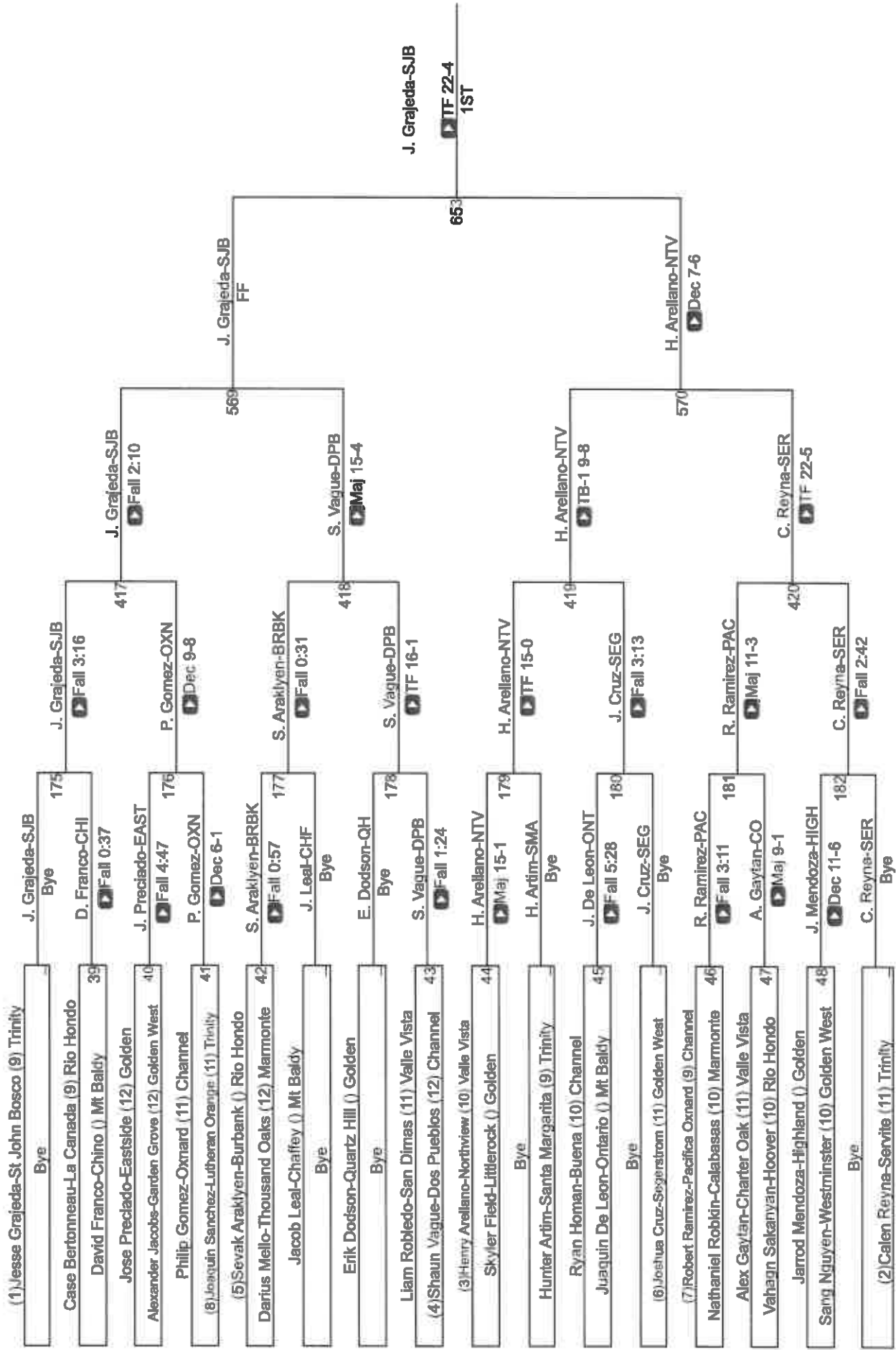

CIF Qualifier 132

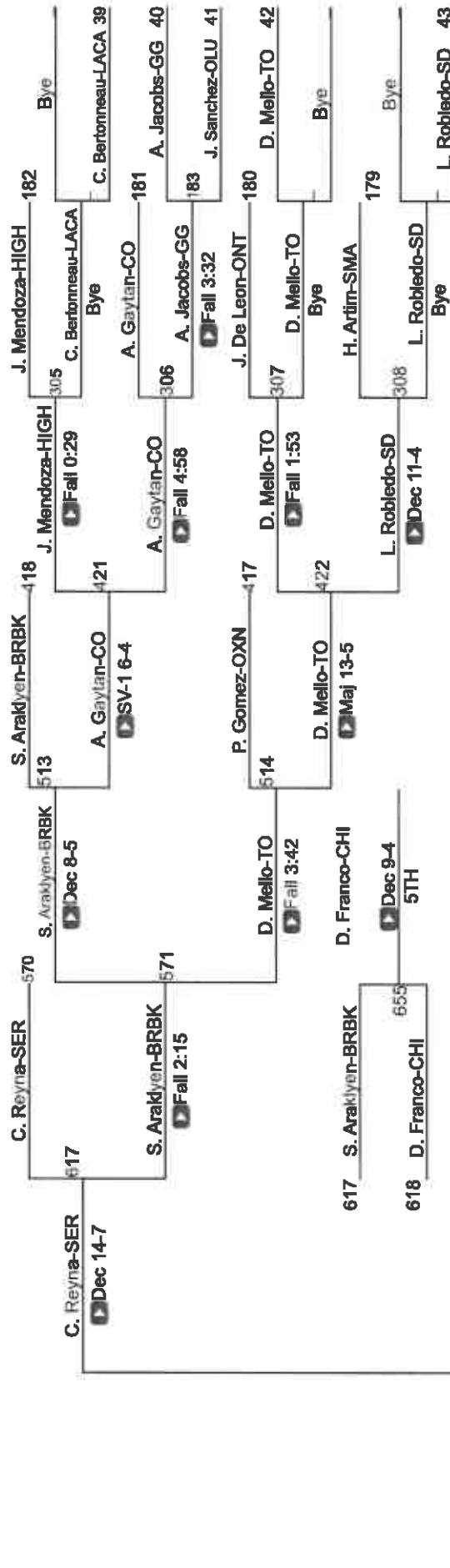

C. Reyna-SER

Inj. 0:00
3RD

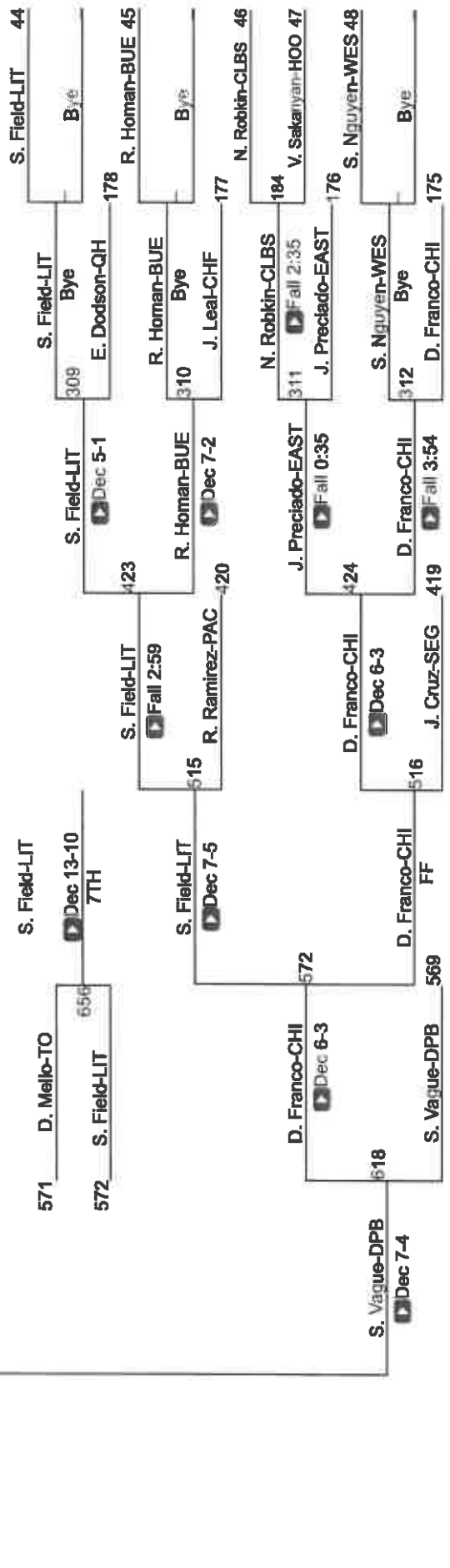

S. Field-LIT

Inj. 0:00
3RD

CIF SS Boys Individuals Coastal Div

CIF Qualifier 138

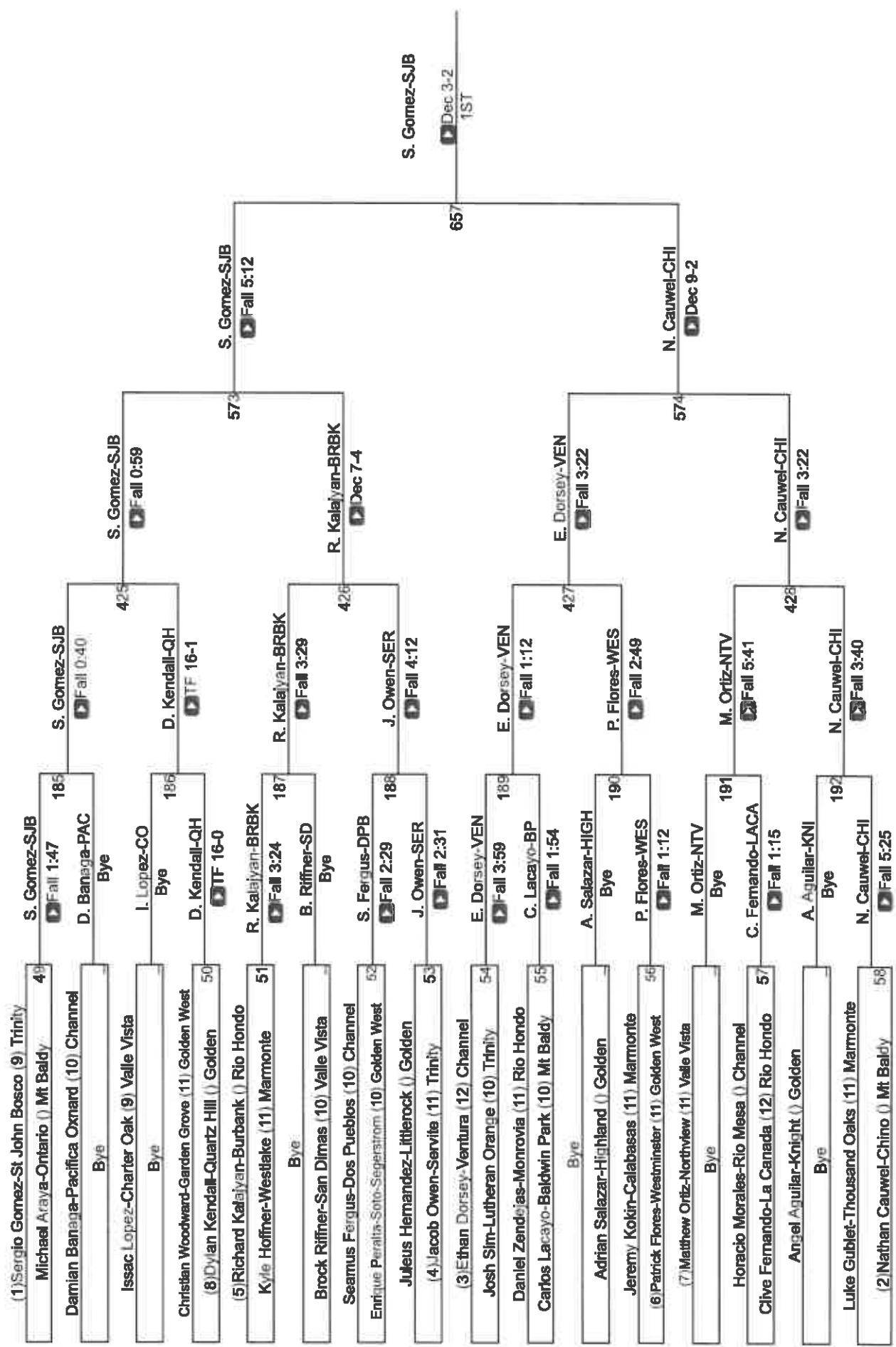

EIF Qualifier 138

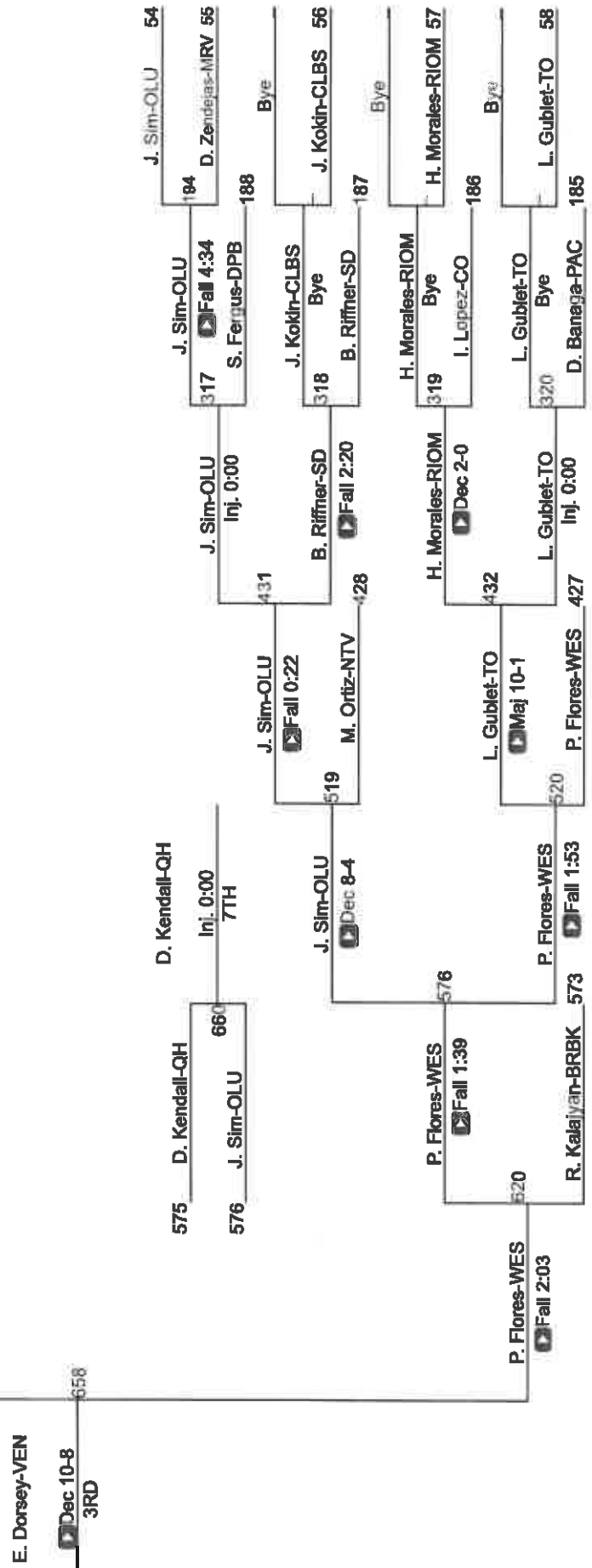
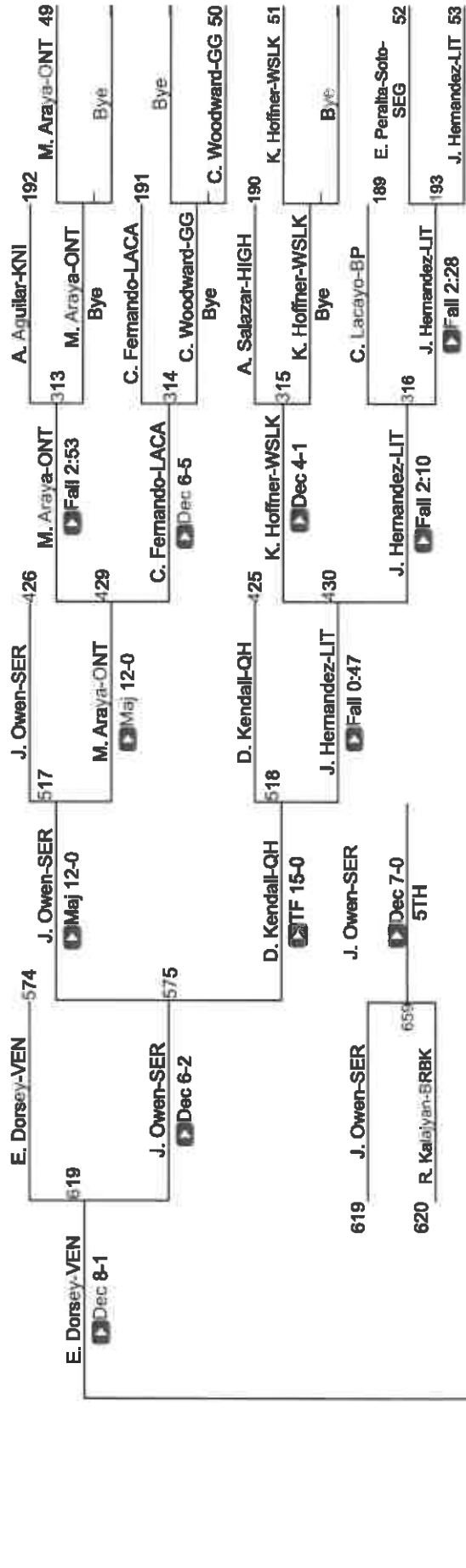

EIF SS Boys Individuals Coastal Div

EIF Qualifier 144

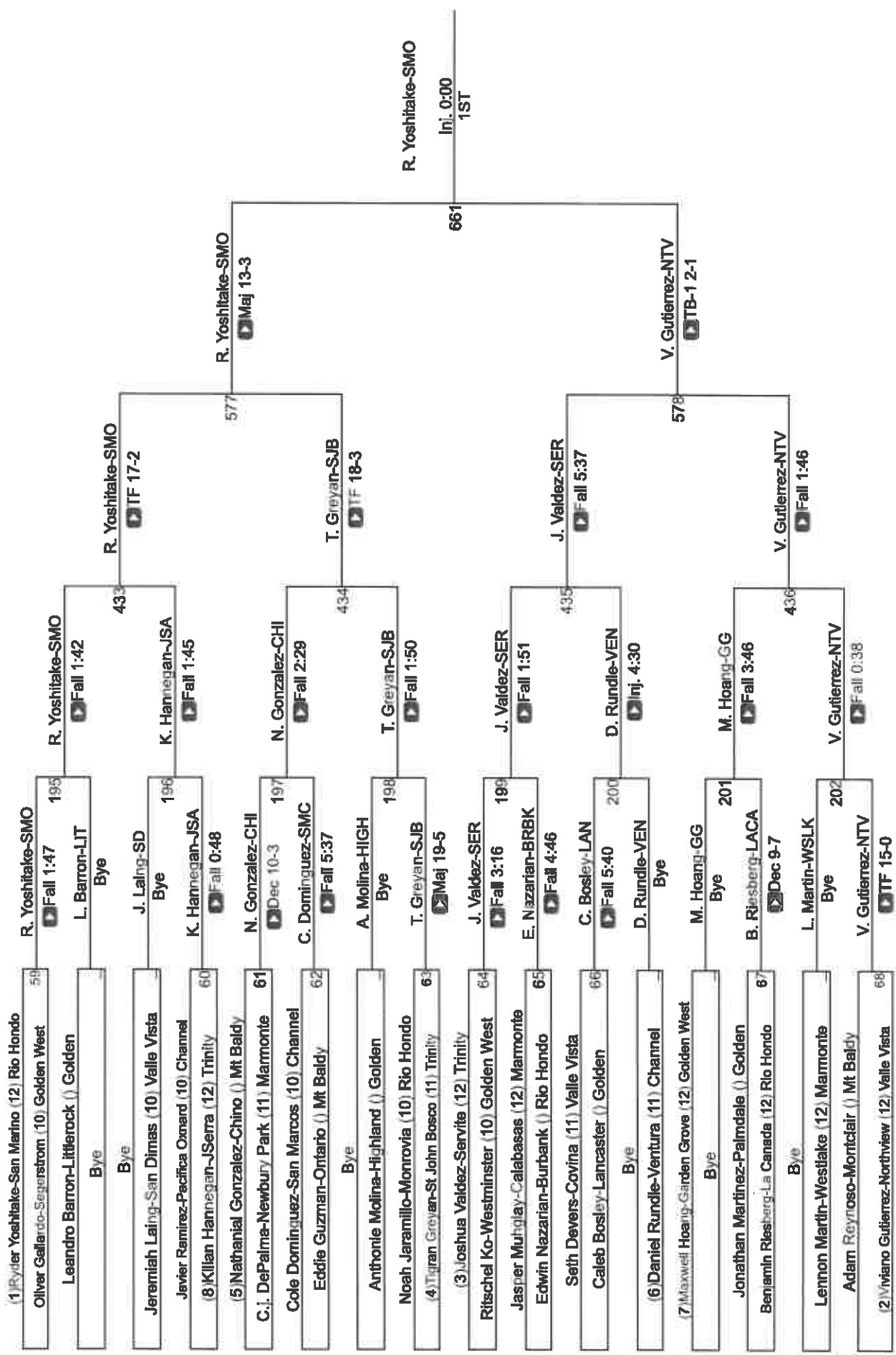

EIF Qualifier 144

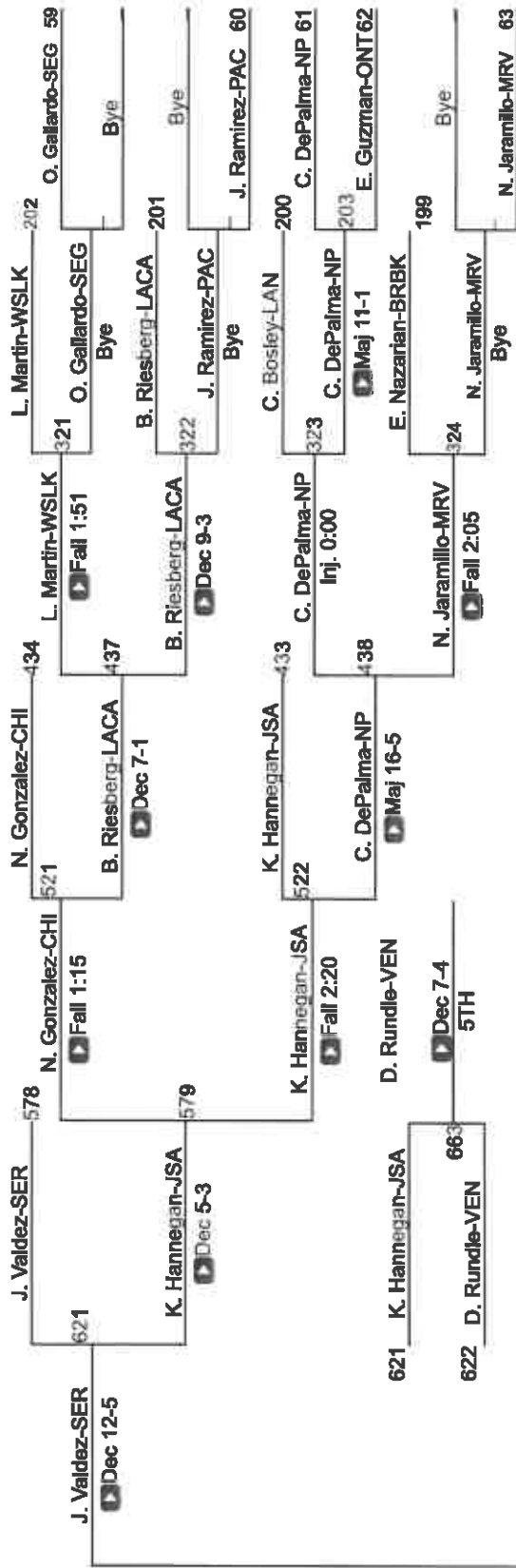

T. Greyan-SJB

Dec 7-3
3RD

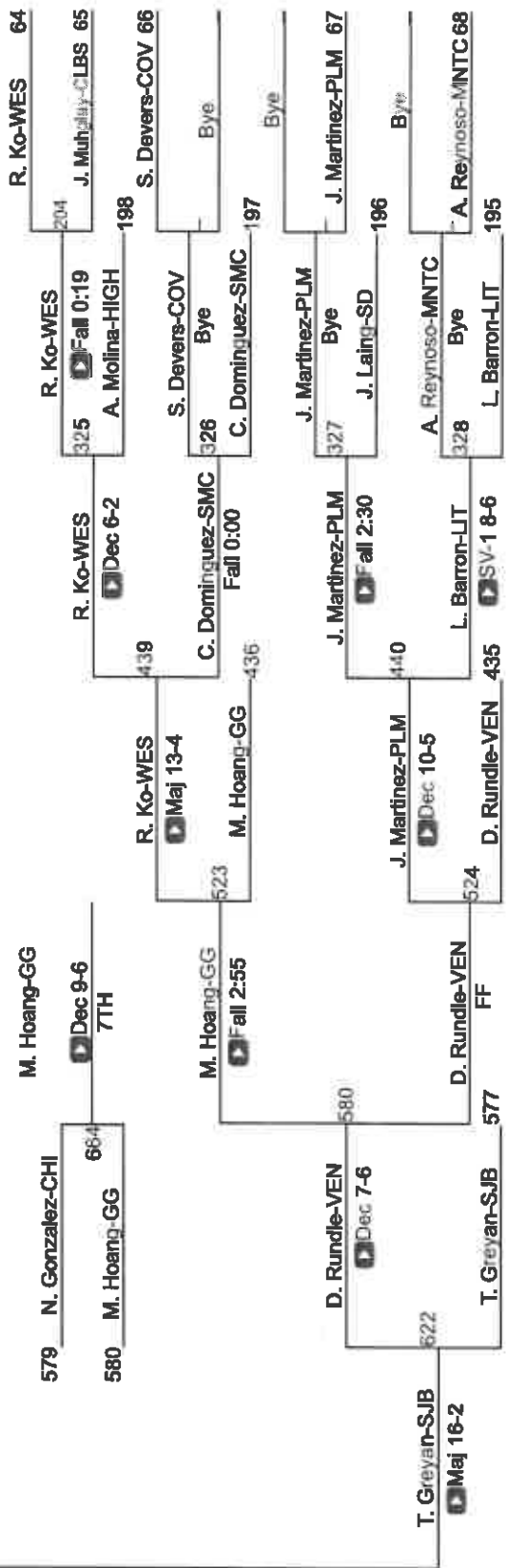

T. Greyan-SJB

Dec 7-3
3RD

EIF SS Boys Individuals Coastal Div

EIF Qualifier 150

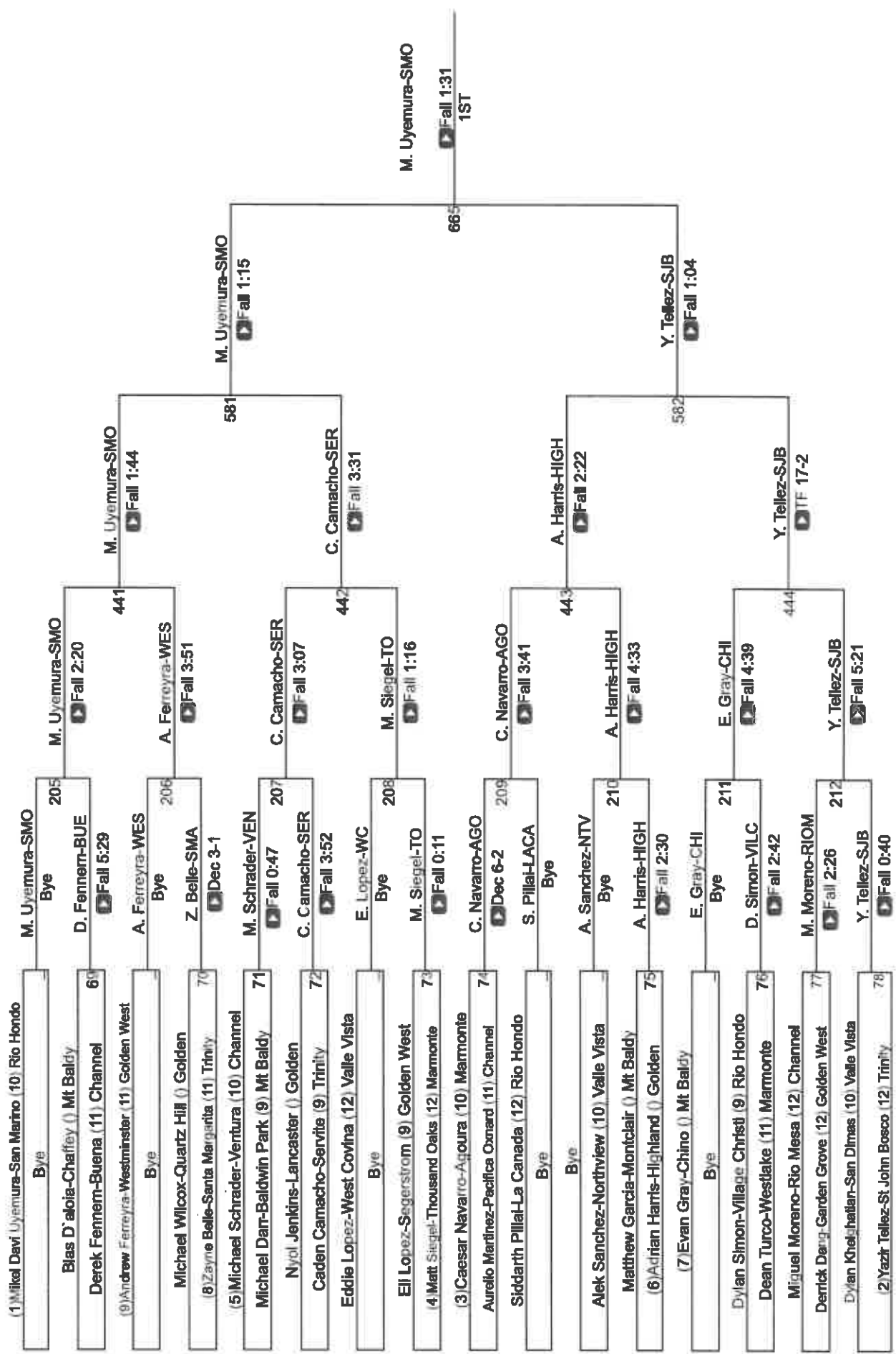

CIF Qualifier 150

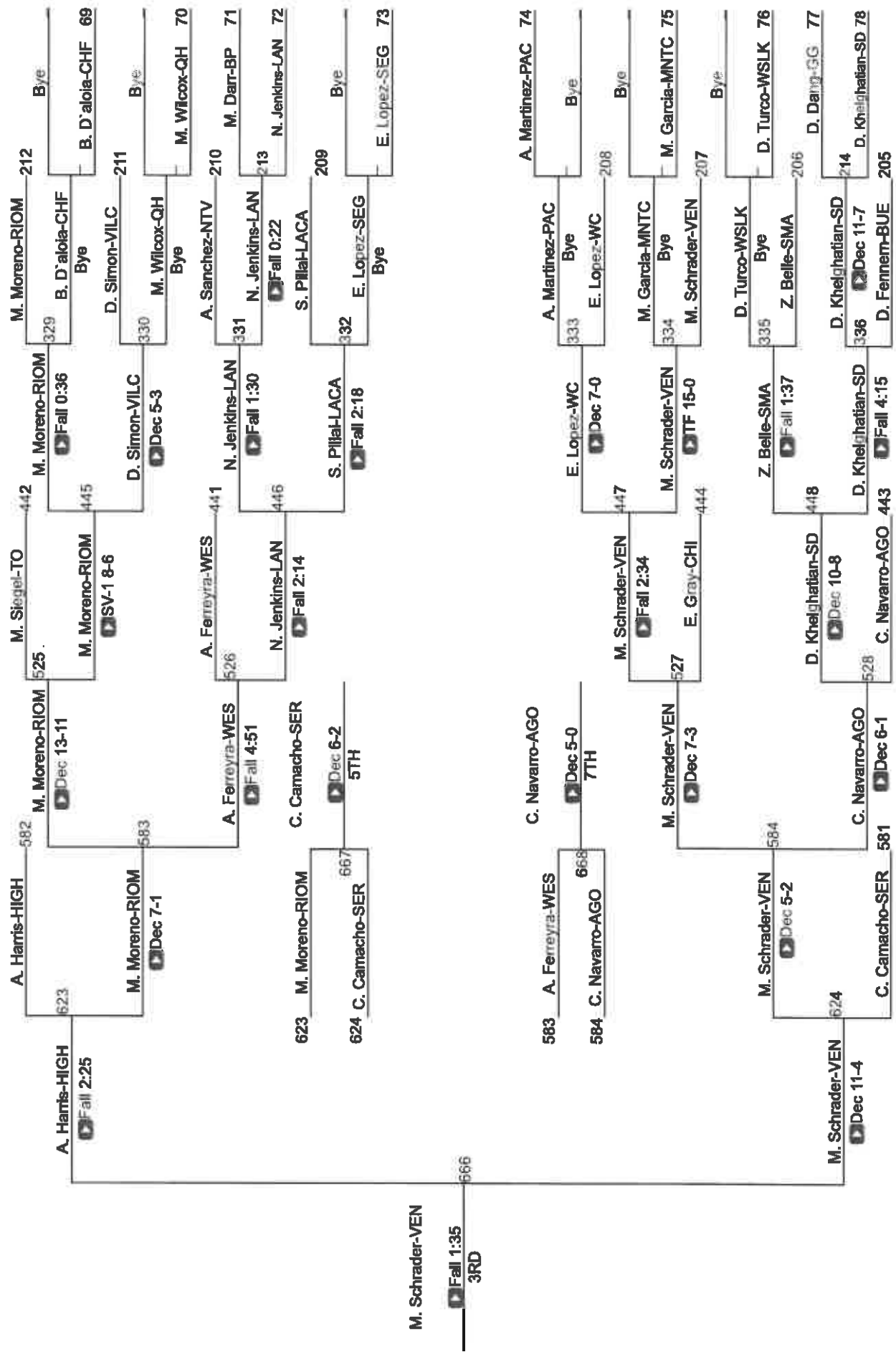

EIF SS Boys Individuals Coastal Div

EIF Qualifier 157

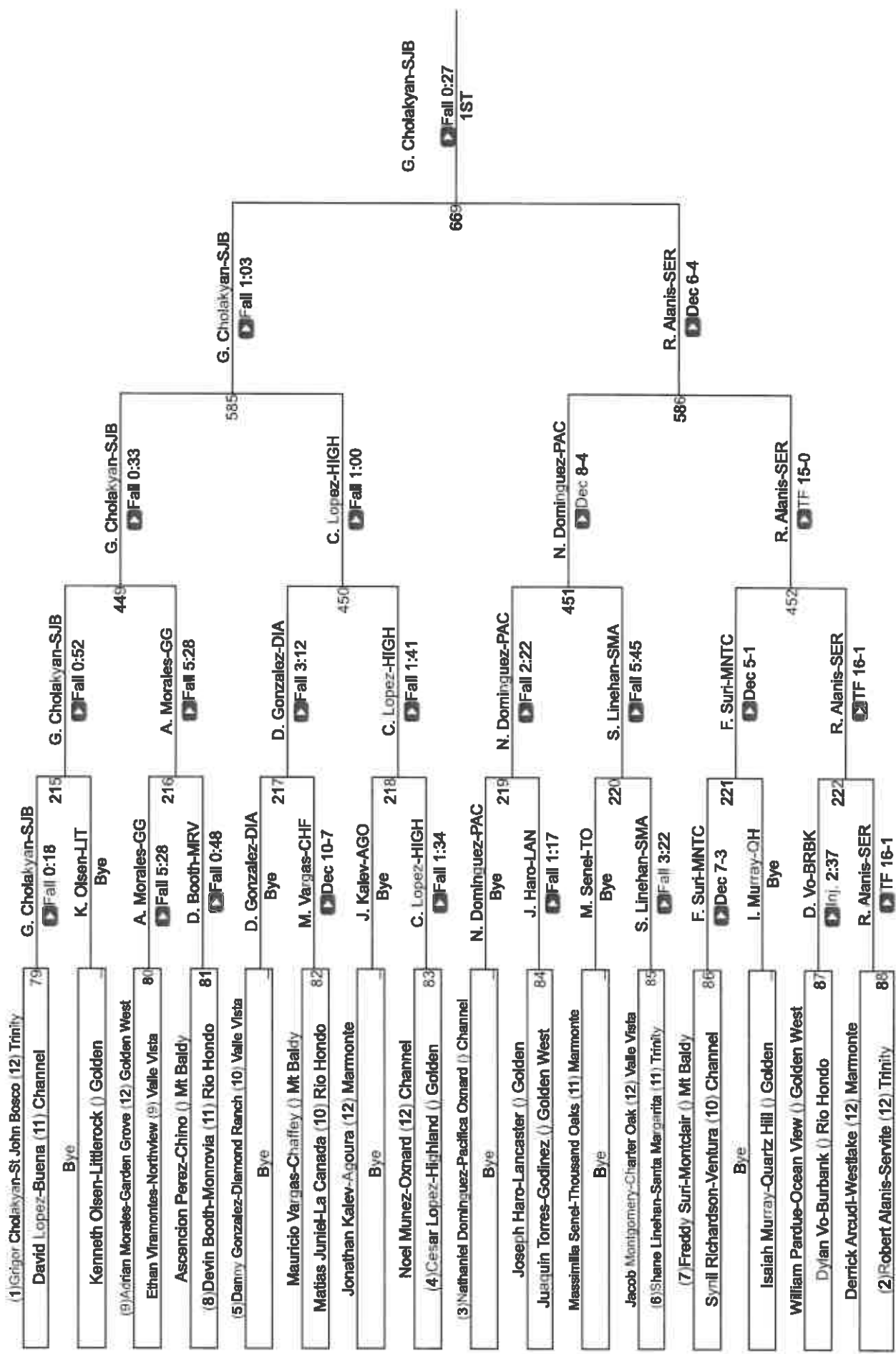

CIF Qualifier 157

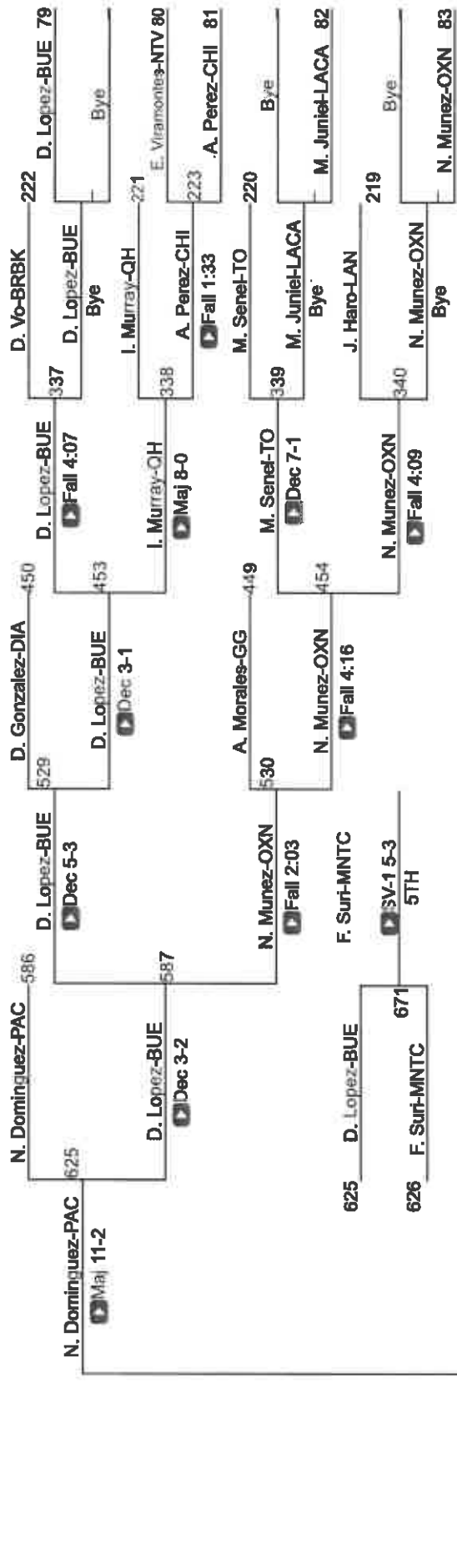

C. Lopez-HIGH

Dec 3-2
3RD

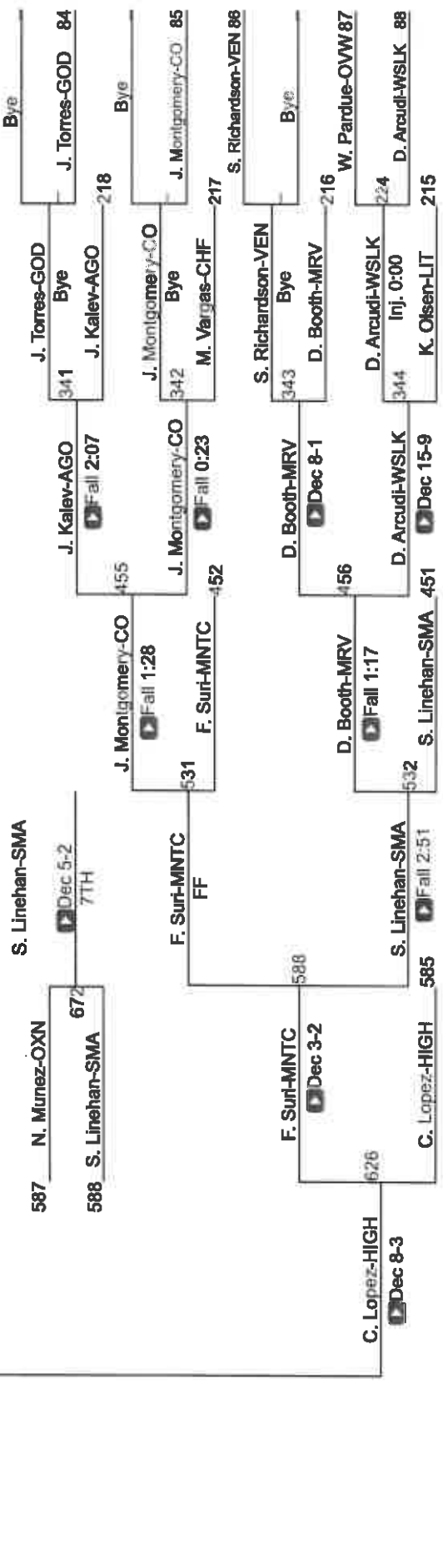

EIF SS Boys Individuals Coastal Div

EIF Qualifier 165

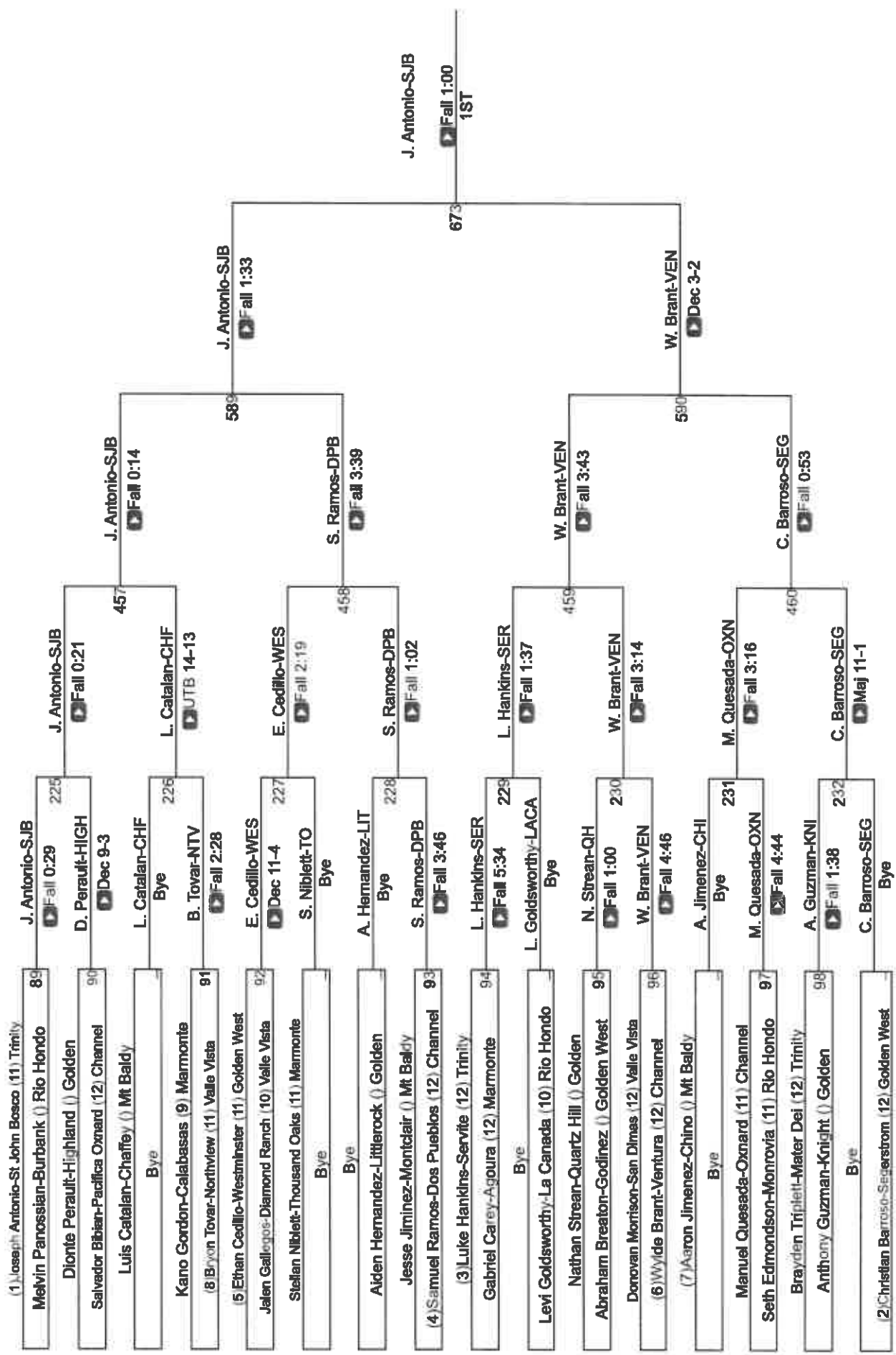

CIF Qualifier 165

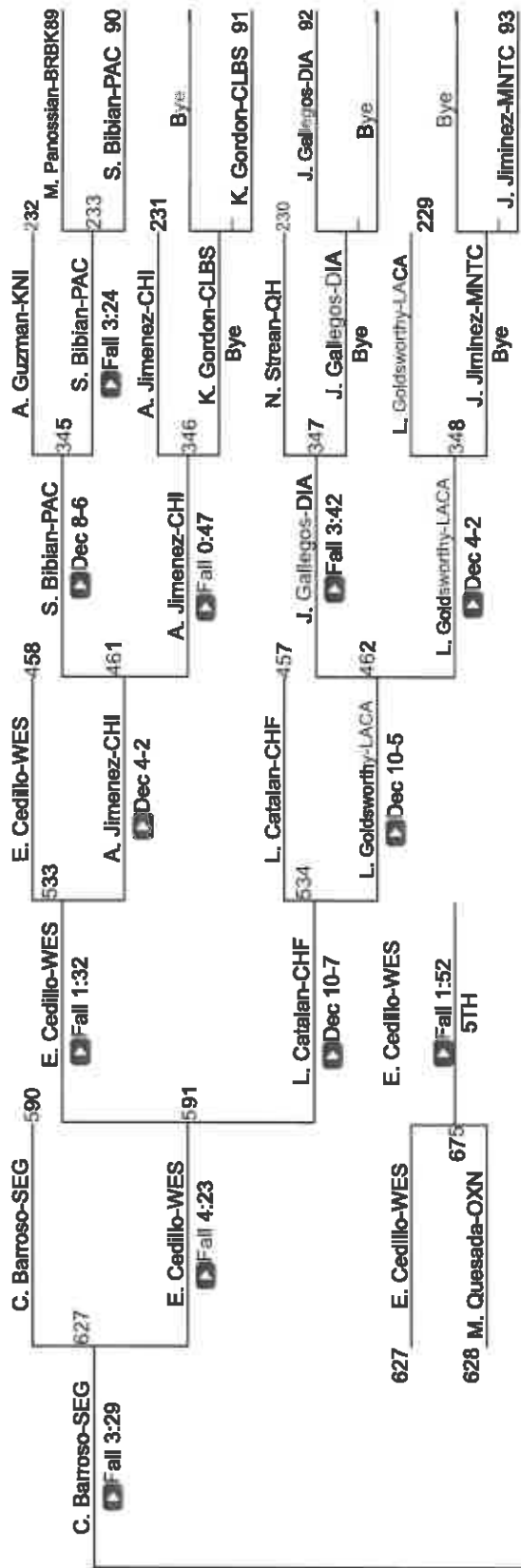

C. Barroso-SEG

SV-1 3-1
3RD

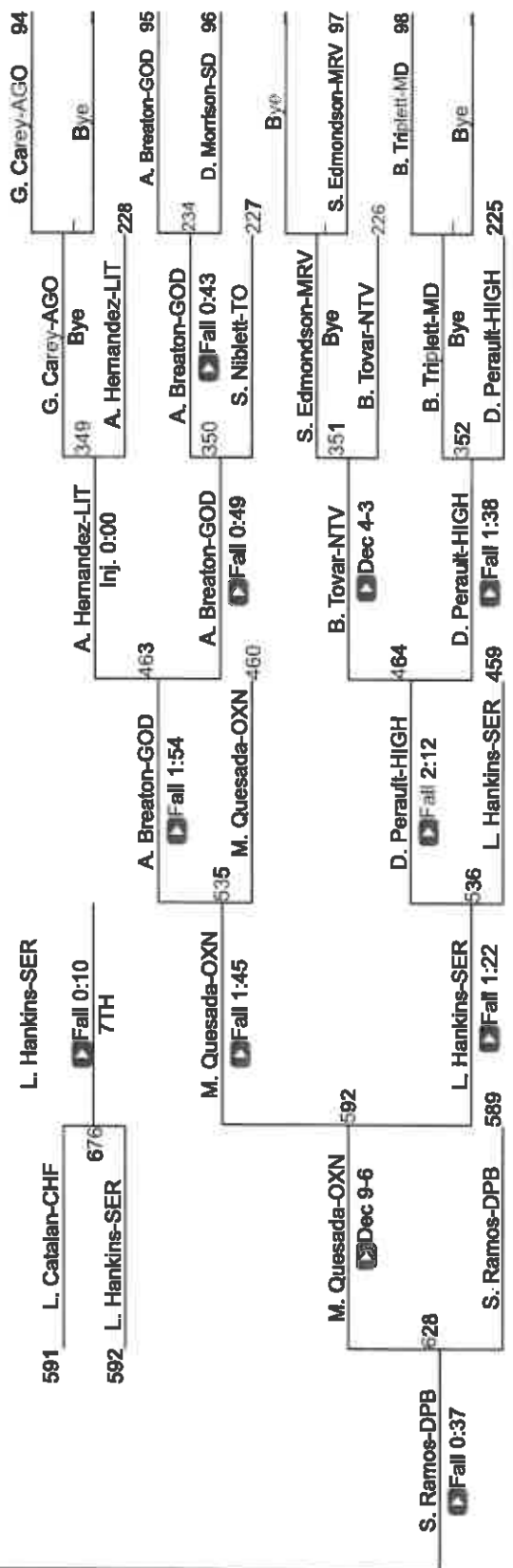

EIF SS Boys Individuals Coastal Div

EIF Qualifier 175

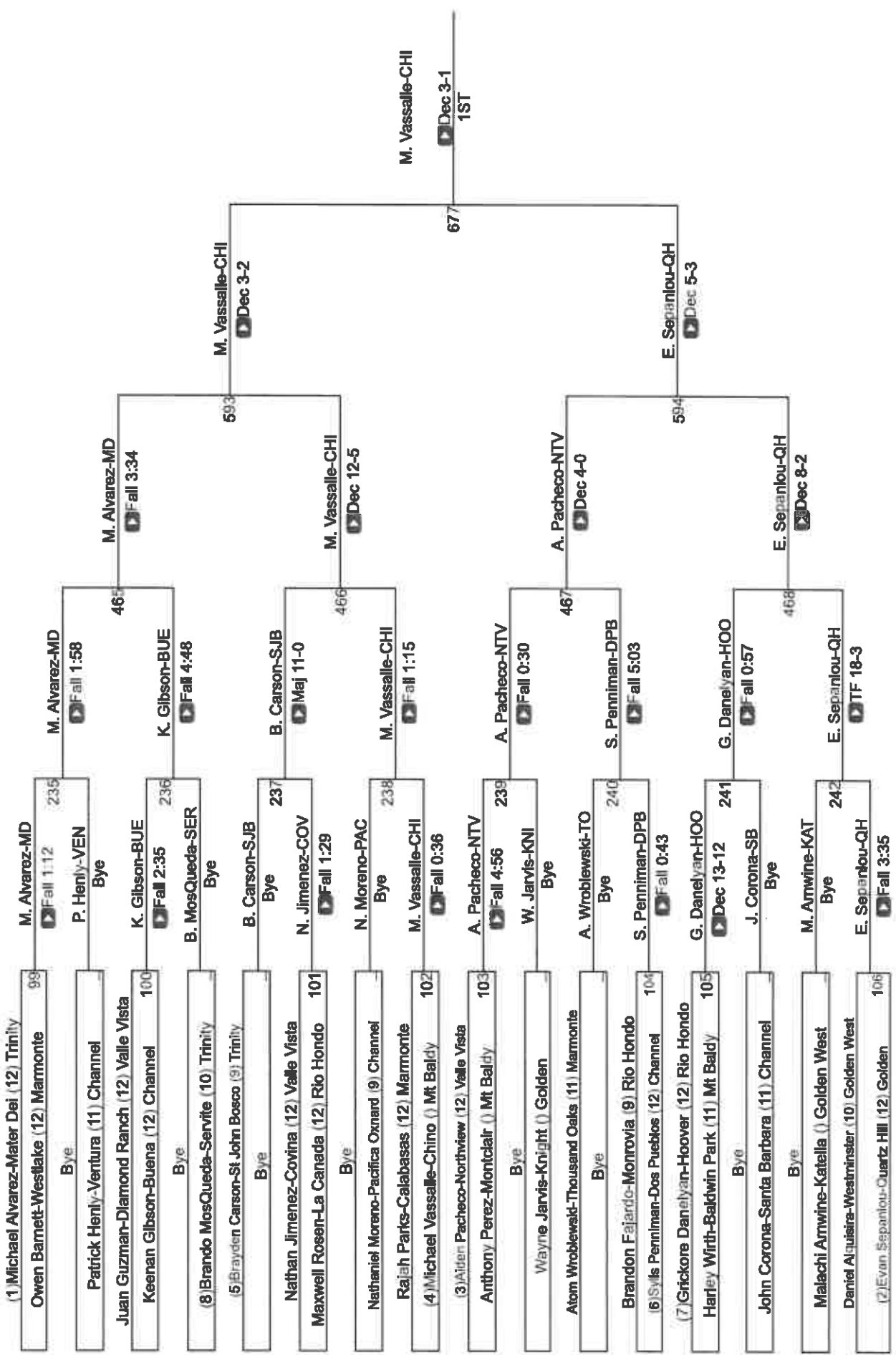

CIF Qualifier 175

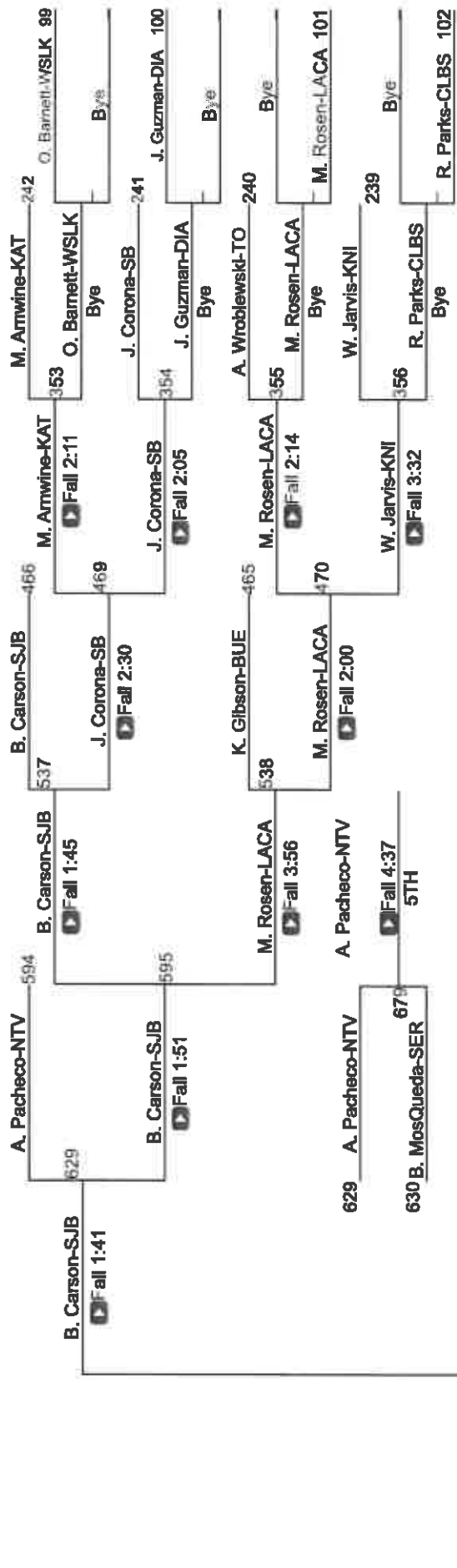

M. Alvarez-MD

Fall 4:32
3RD

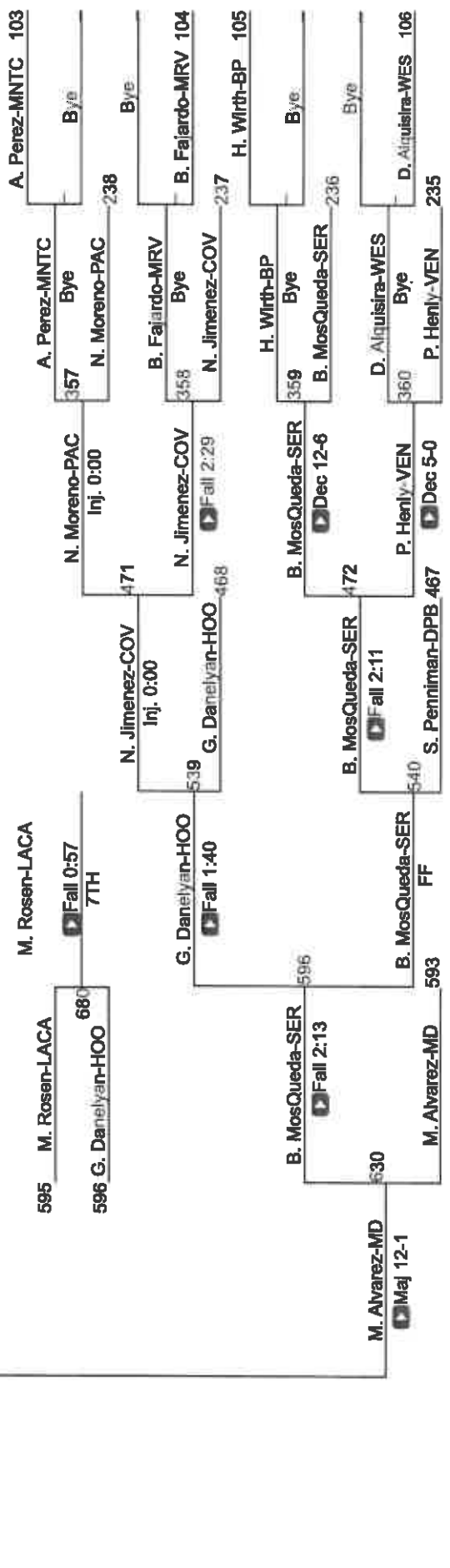

EIF Qualifier 190

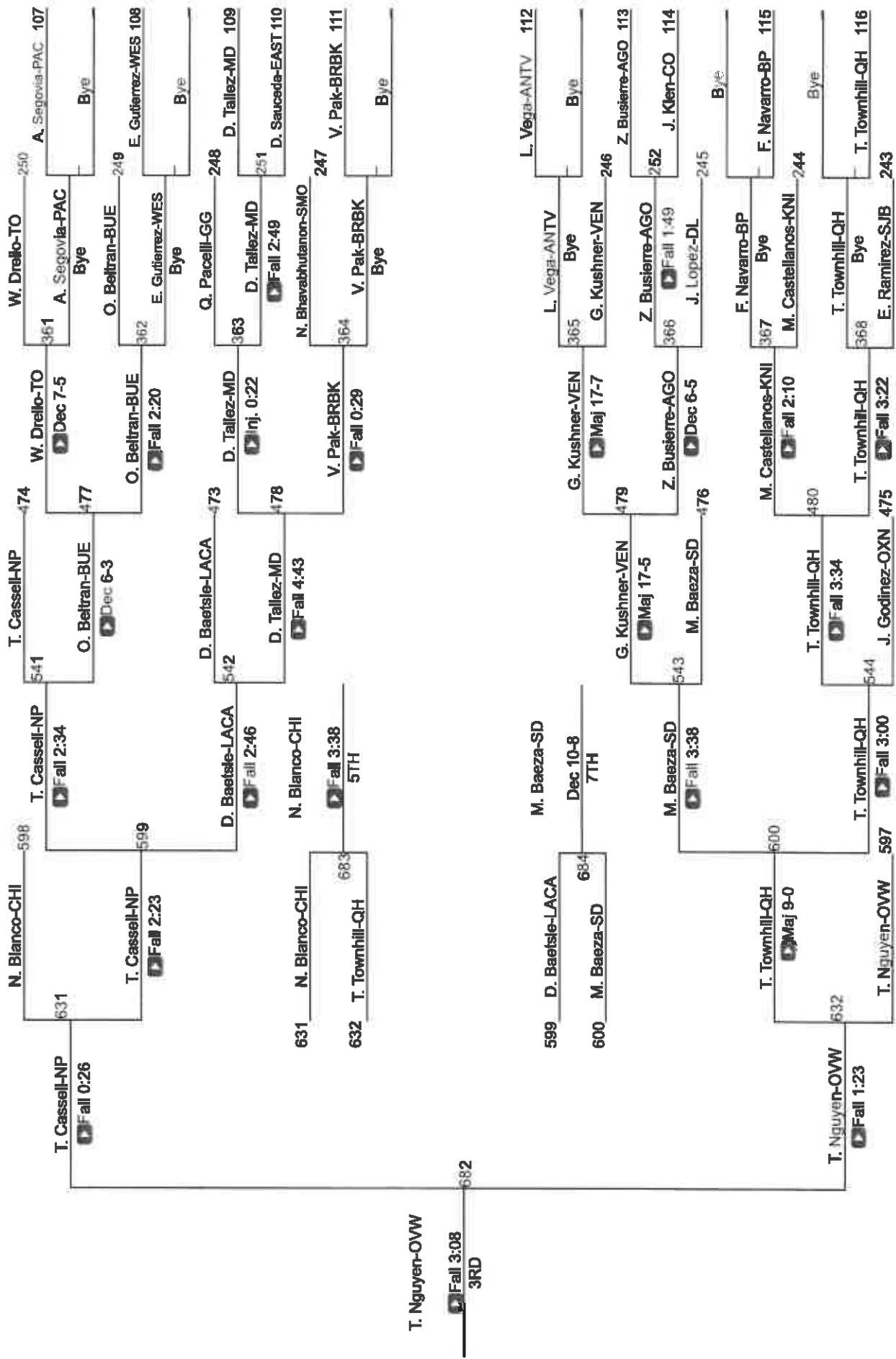

EIF SS Boys Individuals Coastal Div

EIF Qualifier 215

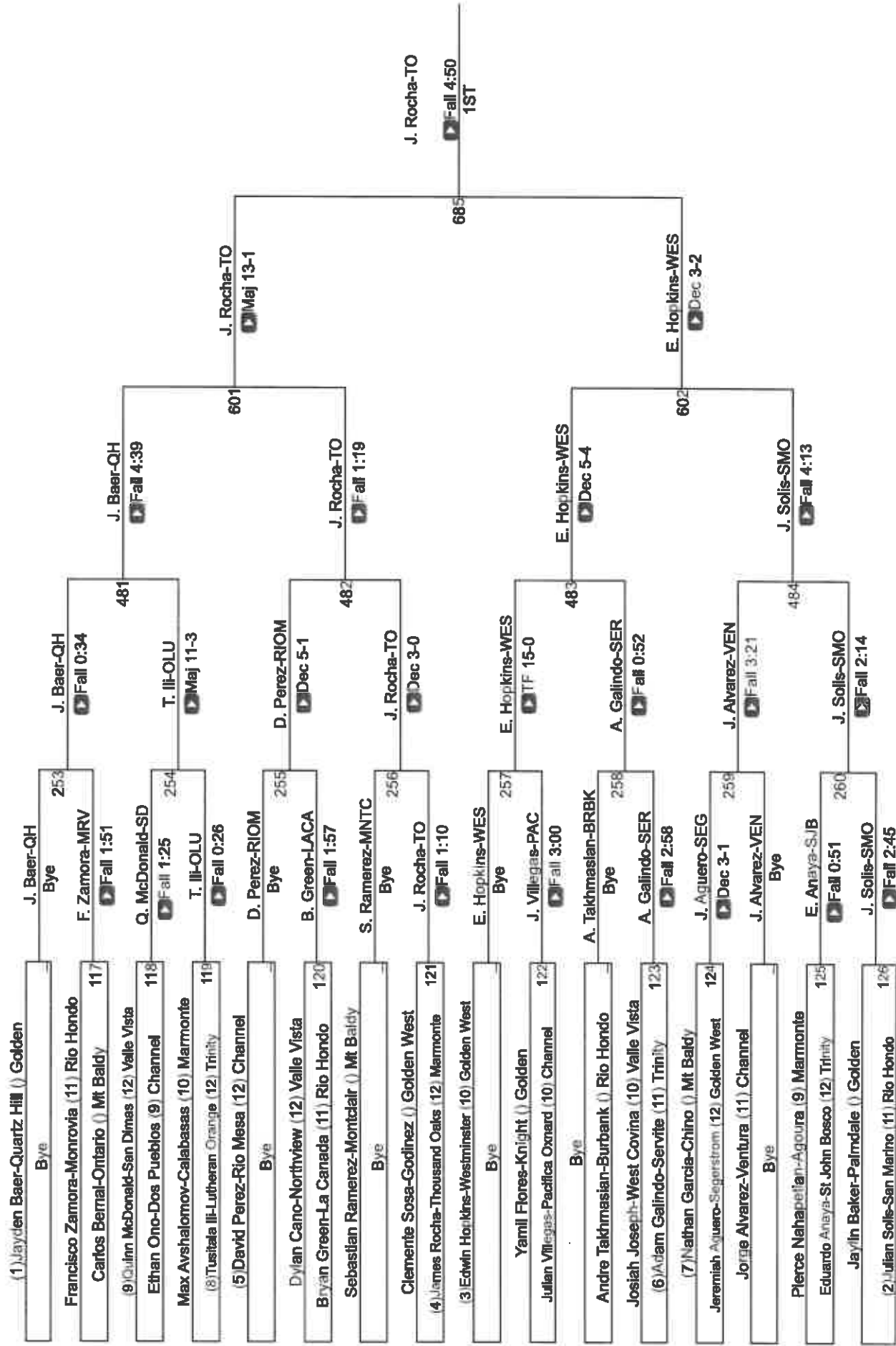

CIF Qualifier 215

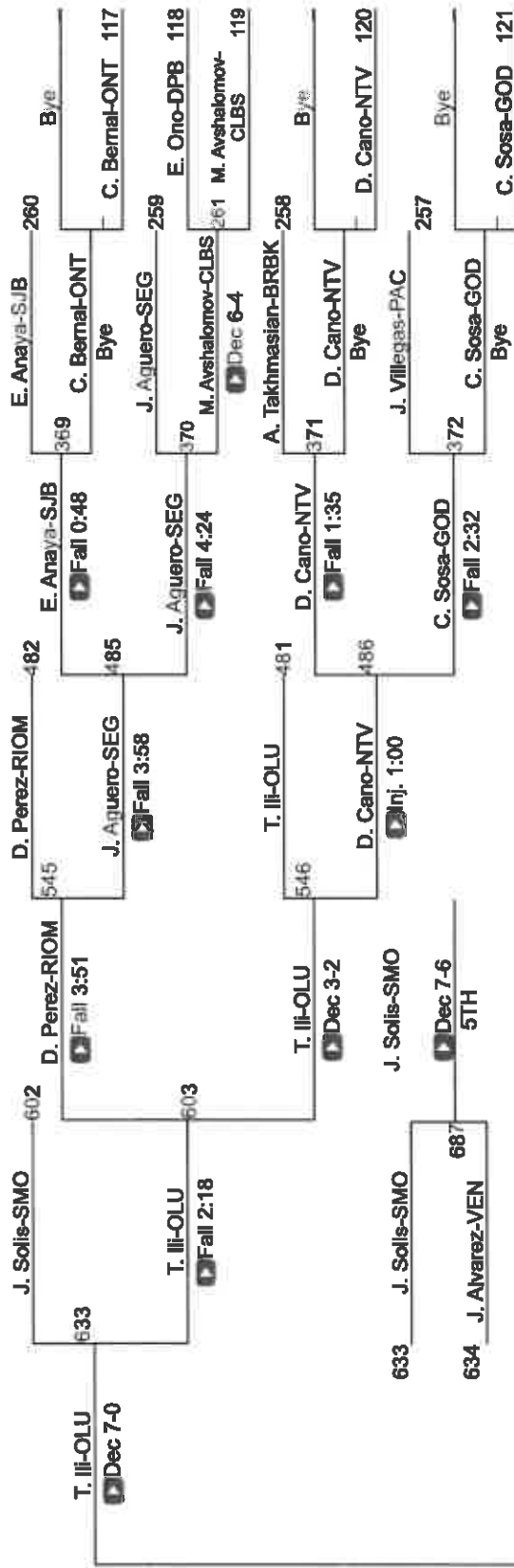

J. Baer-QH

Fall 2:38
3RD

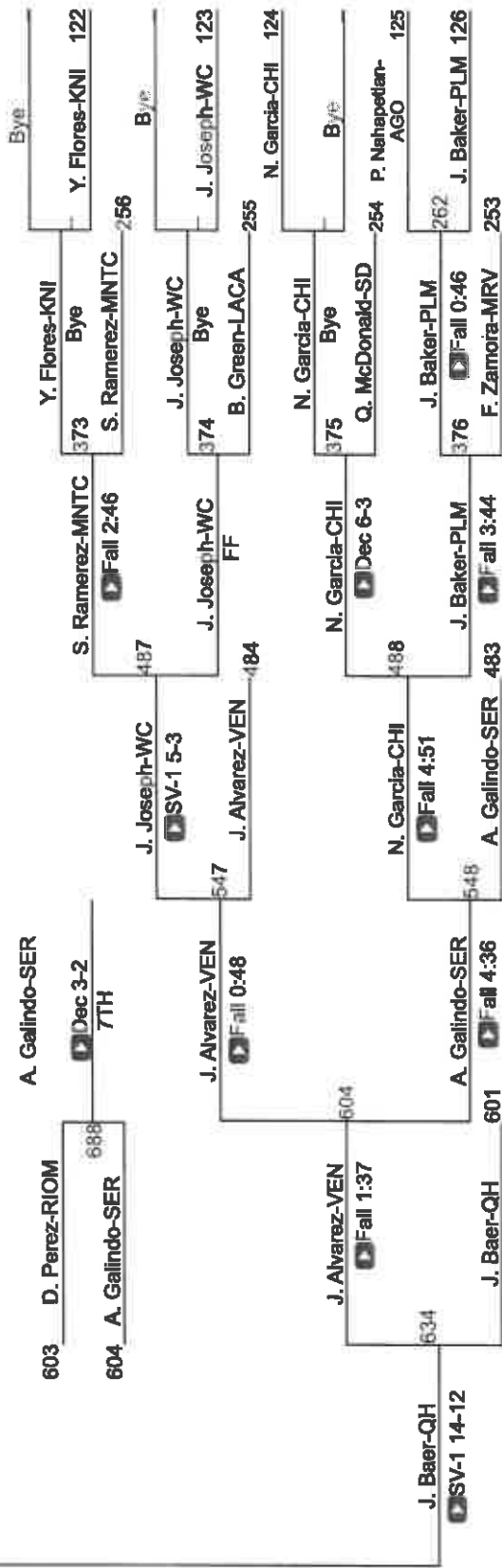

J. Baer-QH

Fall 2:38
3RD

EIF SS Boys Individuals Coastal Div

EIF Qualifier 285

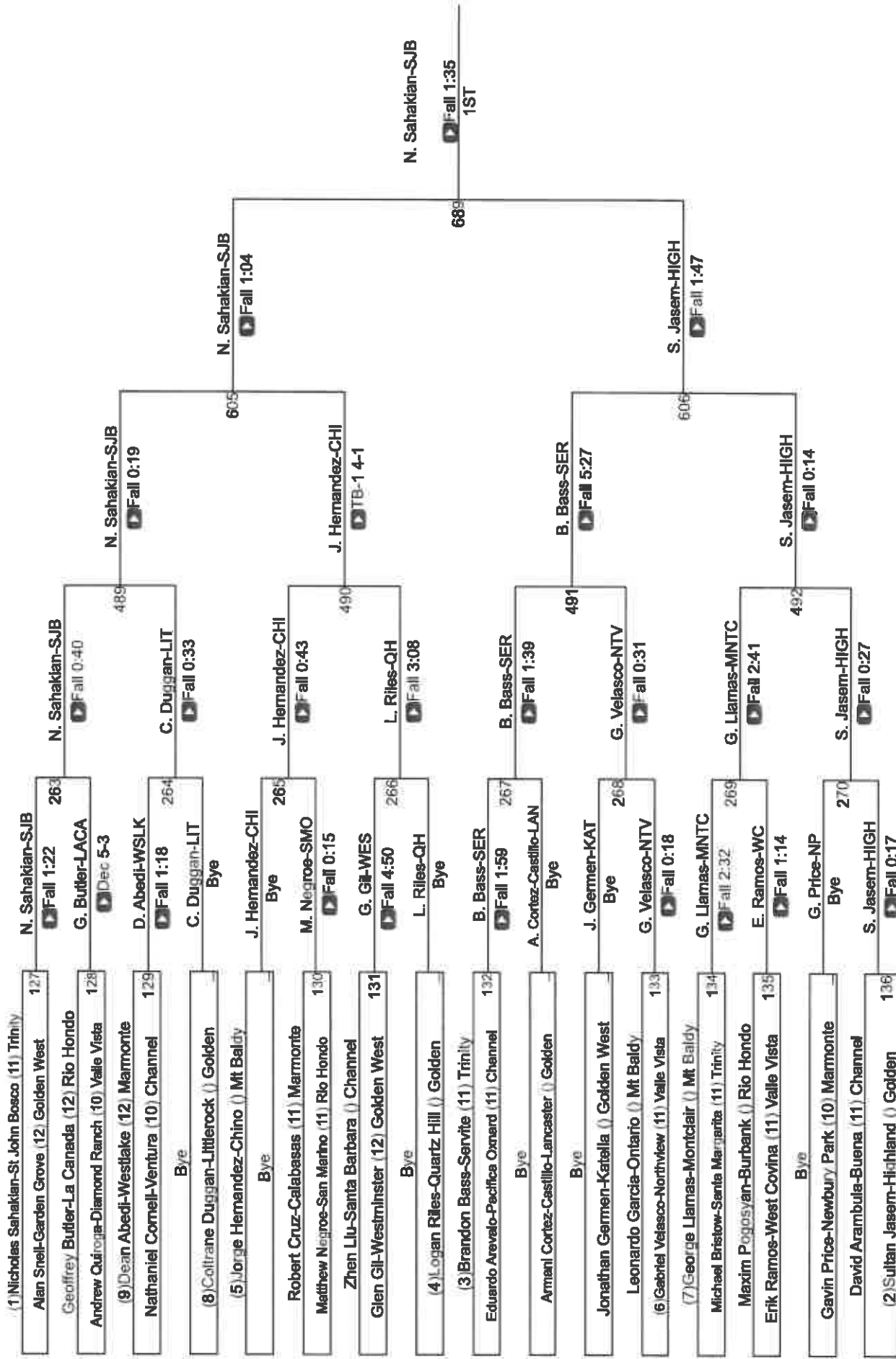

CIF SS Boys Individuals

Eastern Division

John Glenn High School

February 9-10, 2024



Lower Weight MVP

Dylan Guillermo
Palm Desert
144 Pounds

Upper Weight MVP

David Alonso
Palm Desert
165 Pounds

Placers			150 Pounds			Team Score Final		
108 Pounds			150 Pounds			Team Score Final		
1st	Calne Martin	Camarillo	1st	Brock Mantanona	Palm Desert	1	Calvary Chapel SA	299.5
2nd	Maasimo Ortiz	Calvary Chapel SA	2nd	Jacob Beldon	San Clemente	2	Palm Desert	273.5
3rd	Logan Hansen	Royal	3rd	Cross Rodriguez	Calvary Chapel SA	3	Camarillo	195
4th	Caydin Chan	San Clemente	4th	Felloito Nunez	Shadow Hills	4	San Clemente	179
5th	Garen Keahlahian	Aliso Niguel	5th	Christopher Alvarez	Camarillo	5	Royal	167
6th	Vincent Tran	Alhambra	6th	Tomas Fulgentes	Royal	6	Valencia	127.5
7th	Aidan Han	Capo Valley	7th	Dean Gibson	Simi Valley	7	Capo Valley	103.5
8th	Nathan Valencia	Cerritos	8th	Isalah Ulloa	Bell Gardens	8	Trabuco Hills	98
113 Pounds			157 Pounds					
1st	Elijah Poe	Calvary Chapel SA	1st	Andrew Barbosa	Palm Desert	9	Cerritos	92.5
2nd	James Fukuchi	Cerritos	2nd	Benjamin Kirk	Royal	10	West Valley	84
3rd	Jonathan Sanchez	John Glenn	3rd	Bobby Baeder	Dana Hills	11	Aliso Niguel	83.5
4th	Ian Encarnacion	Costa Mesa	4th	Henry Egami	Valencia	12	El Toro	80
5th	Dylan Carlos	Shadow Hills	5th	Christian Montee	El Toro	13	Shadow Hills	77
6th	Sean Zapata	Camarillo	6th	Emmanuel Sandoval	Camarillo	14	Dana Hills	76.5
7th	Dayle Calles	Valencia	7th	Zale Ming	Mission Viejo	15	John Glenn	71
8th	Alexander Portillo	Santa Ana	8th	Reese Elliott	San Jacinto	16	Liberty	69
120 Pounds			165 Pounds					
1st	Slater Hicks	Valencia	1st	David Alonso	Palm Desert	17	La Quinta	60
2nd	Mason Carillo	Royal	2nd	Dylan Trevino	Calvary Chapel SA	18	Bell Gardens	59
3rd	Kavi Garvey	Dana Hills	3rd	Nathan Castellanos	Trabuco Hills	19	Tesoro	58
4th	Salvador Ardon	Camarillo	4th	Christian Carchi	Simi Valley	20	Santa Ana	54
5th	Edmon Altunyan	Montebello	5th	Kelen Stever	San Clemente	21	Montebello	51
6th	Gary Johnson	Palm Desert	6th	William Schindeler	El Toro	22	Mission Viejo	49
7th	Troy Torres	Calvary Chapel SA	7th	Balmoris Ardon	Camarillo	23	Simi Valley	47
8th	Jovani Alvarado	Tahquitz	8th	Matthew Flores	Bell Gardens	24	Perris	44
126 Pounds			176 Pounds					
1st	Aaron Silva	Calvary Chapel SA	1st	Max McWilliams	Calvary Chapel SA	25	Valley View	40
2nd	Solomon Resnick	Capo Valley	2nd	Gabriel Barragan	West Valley	26	Moorpark	38
3rd	Isaac Ghaffar	Camarillo	3rd	Alex Lopez	Valencia	27	Schurr	34
4th	Khaisen Chen	Aliso Niguel	4th	Daniel Fralley	Trabuco Hills	28	Costa Mesa	32
5th	Johnny Overgaag	Palm Desert	5th	Matin Ghanavat	Capo Valley	29	Alhambra	27.5
6th	Vicente Juarez	Cerritos	6th	Julian Castro	La Quinta	30	Rancho Mirage	26
7th	Alberto Enriquez	John Glenn	7th	Nehemiah Ramirez	Shadow Hills	31	San Jacinto	26
8th	Manuel Meza	Calvary Chapel Downey	8th	Nicholas Tatar	Palm Desert	32	Tahquitz	24
132 Pounds			190 Pounds					
1st	Joshua Requena	Camarillo	1st	Diego Costa	Palm Desert	33	Calvary Chapel Downey	20
2nd	Vinnie Gutierrez	Calvary Chapel SA	2nd	Dylan Henry	San Clemente	34	Estancia	20
3rd	Jacob Enriquez	John Glenn	3rd	Brett Williamson	Moorpark	35	Orange Vista	18
4th	Enzo Guerra	Tesoro	4th	Nathan Hutton	West Valley	36	Citrus Hill	12
5th	Triston Valdez	Palm Desert	5th	Jacob Ramirez	Liberty	37	Santiago GG	11
6th	Diego Zavaia	Montebello	6th	Kallin Youkhan	Trabuco Hills	38	Artesia	10
7th	John Santy	El Toro	7th	Jacob Sanchez	La Quinta	39	Orange	10
8th	Izaac Rosales	Orange Vista	8th	Jasper Garcia	Santa Ana	40	Saddleback	8
138 Pounds			215 Pounds					
1st	Jayden Ho	San Clemente	1st	Diego Morales	Palm Desert	41	San Juan Hills	8
2nd	Vincent Hanna	Calvary Chapel SA	2nd	Dylan Backer	Liberty	42	Palm Springs	6
3rd	Brody Denham	Royal	3rd	Kevin Casillas	Capo Valley	43	Vista Del Lago	5
4th	Addiel Orozco	Palm Desert	4th	Jairdan Chopra	Valencia	44	Rancho Verde	4
5th	Drew Permutter	Camarillo	5th	Max Bolliger	San Clemente	45	Moreno Valley	3
6th	Jayden Lin	Cerritos	6th	Chris Lopez	La Quinta	46	Mark Keppel	2
7th	Judd Rambo	Tesoro	7th	Nelson Lacona	Dana Hills			
8th	Tyler Ellmann	Capo Valley	8th	William Taylor Iv	Mission Viejo			
144 Pounds			285 Pounds					
1st	Dylan Guillermo	Palm Desert	1st	Nathan Nieves	Calvary Chapel SA			
2nd	Niko Valenzuela	Calvary Chapel SA	2nd	Peter Fulgentes	Royal			
3rd	Andrew Gonzalez	Camarillo	3rd	Romario Bonilla	Perris			
4th	Brock Kenney	Trabuco Hills	4th	Andrew Romero	El Toro			
5th	Adam Wronski	San Clemente	5th	Damian Rosales	West Valley			
6th	Gavin Meraw	Aliso Niguel	6th	Isahia Ledesma	Santa Ana			
7th	Daniel Morales	Tesoro	7th	Luke Mihele	San Clemente			
8th	David Ohanesian	Mission Viejo	8th	Armando Martinez	Palm Springs			

EIF SS Boys Individuals Eastern Div

EIF Qualifier 106

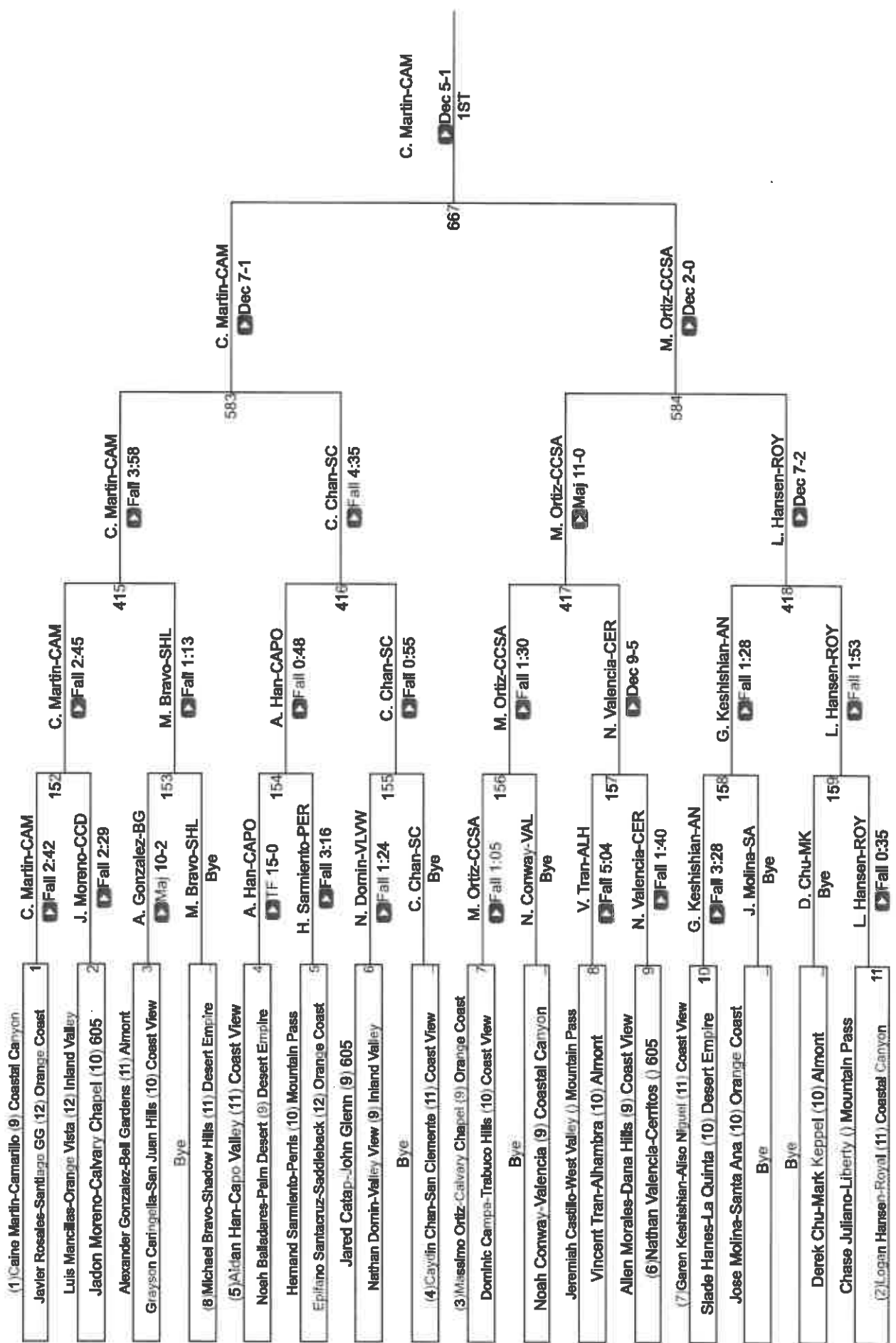

EIF Qualifier 106

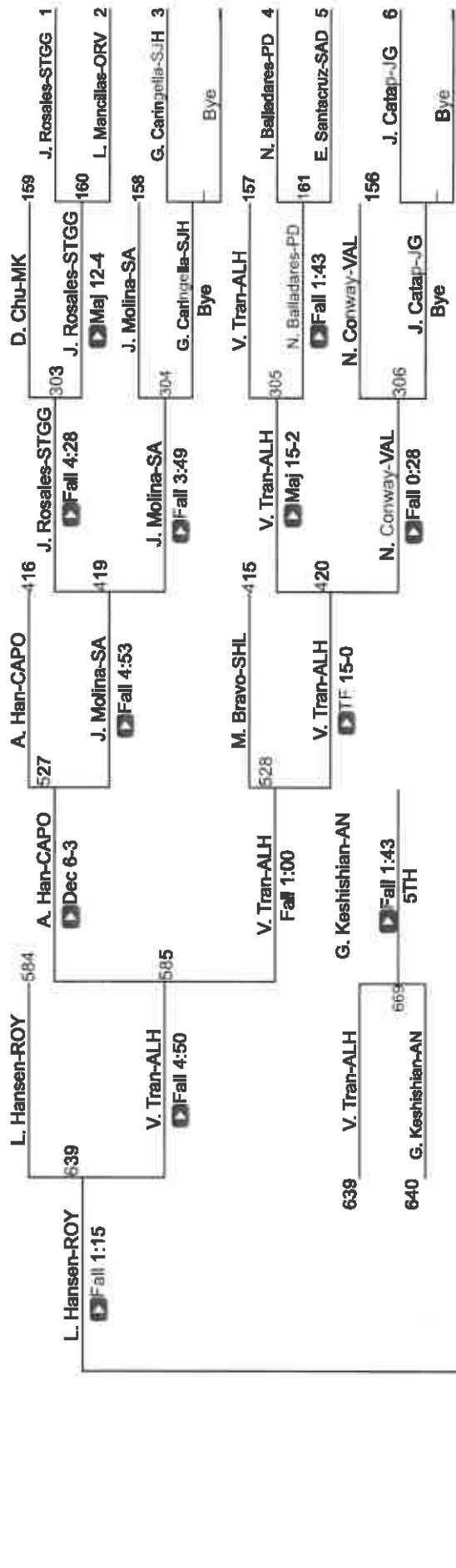

L. Hansen-ROY

Dec 4-0
3RD

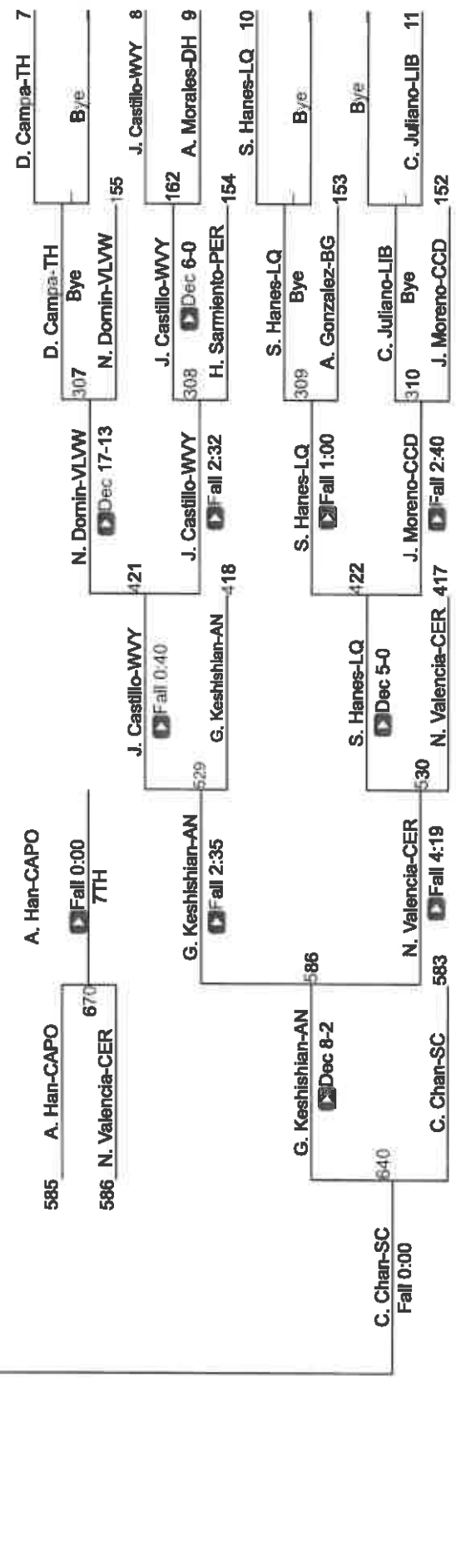

L. Hansen-ROY

Dec 4-0
3RD

EIF SS Boys Individuals Eastern Div

EIF Qualifier 113

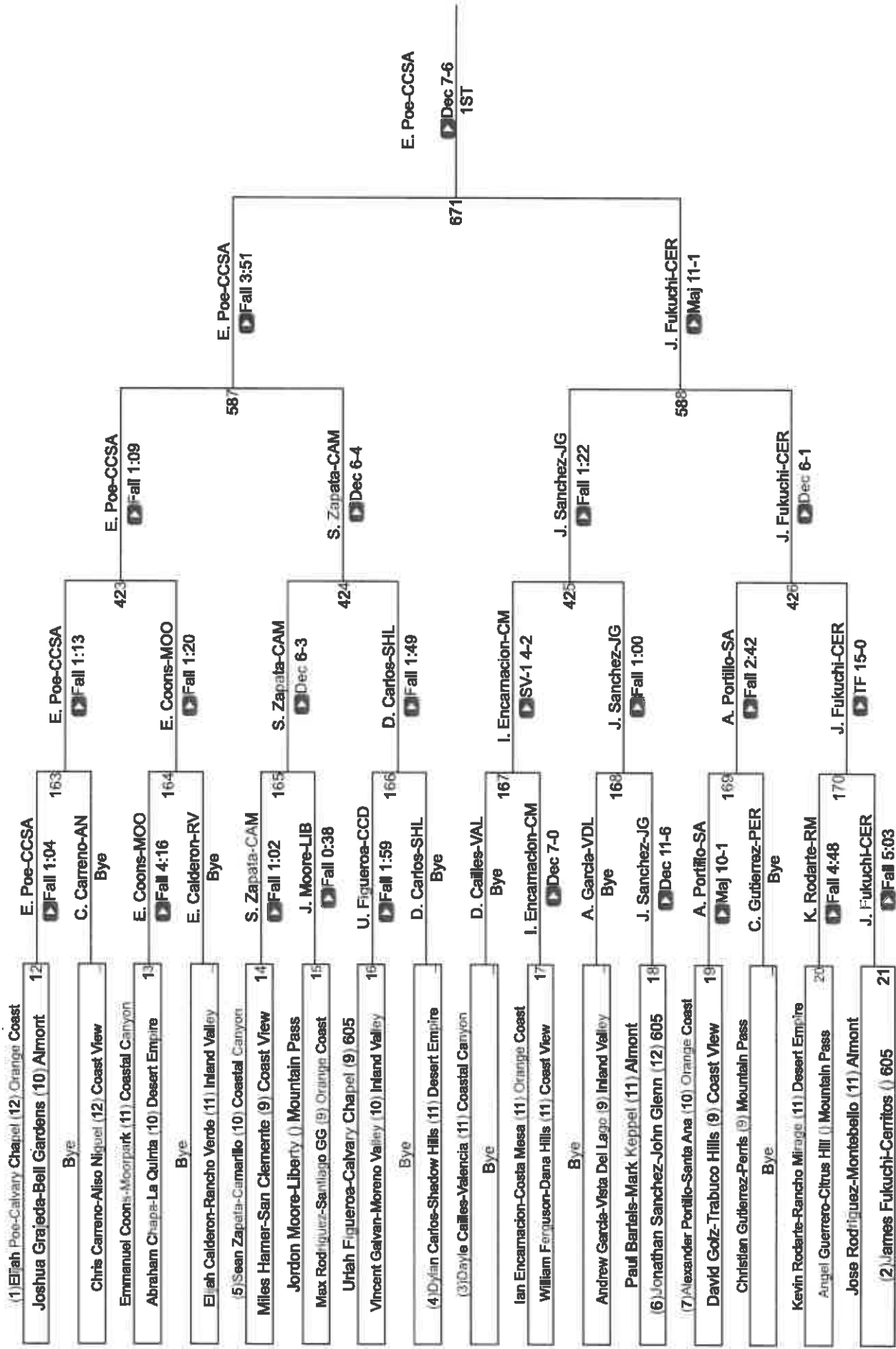

CIF Qualifier 113

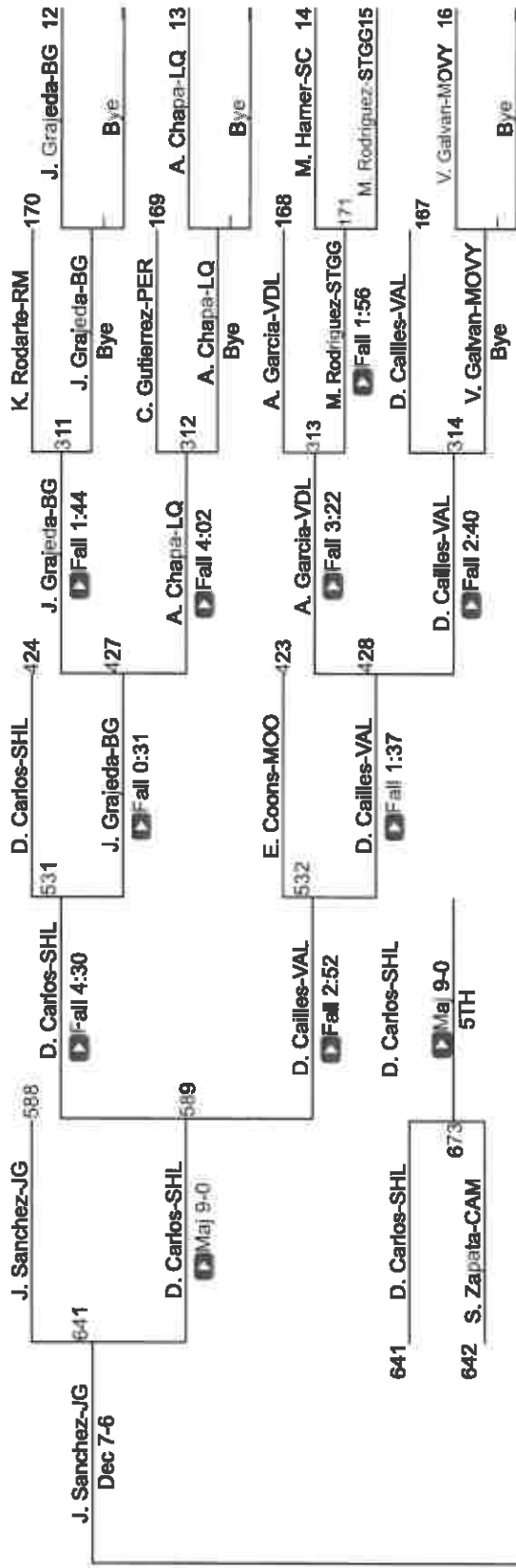

J. Sanchez-JG

Dec 7-0
3RD

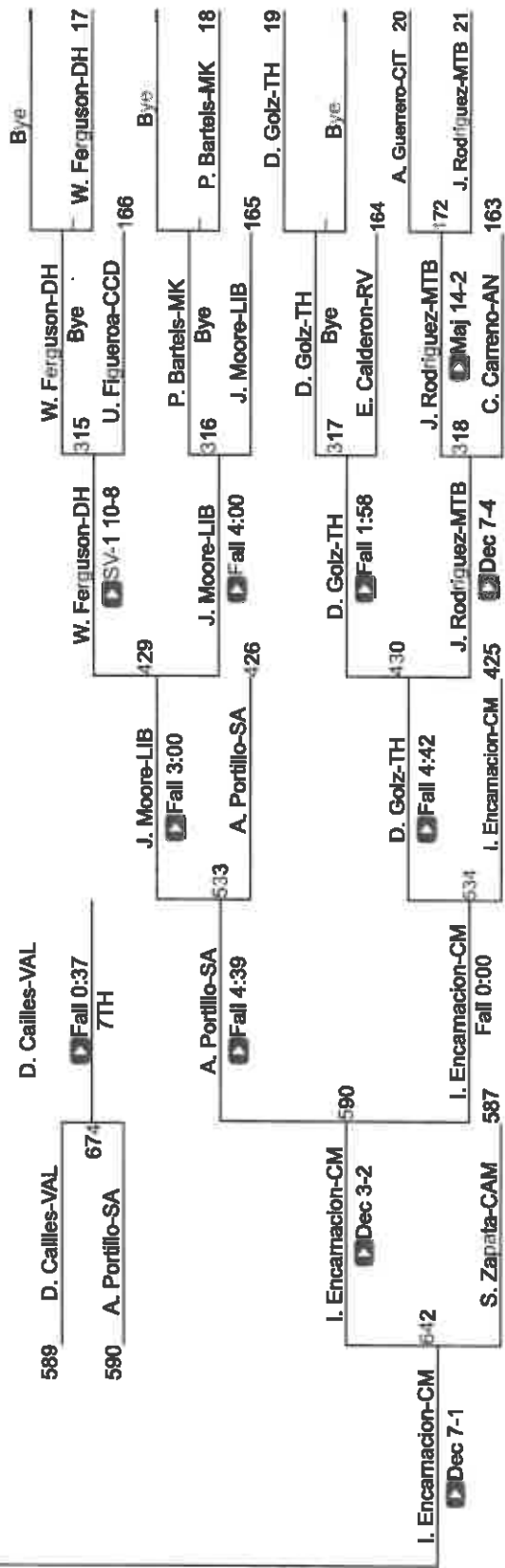

I. Encarnacion-CM
Dec 7-1

163

EIF SS Boys Individuals Eastern Div

EIF Qualifier 120

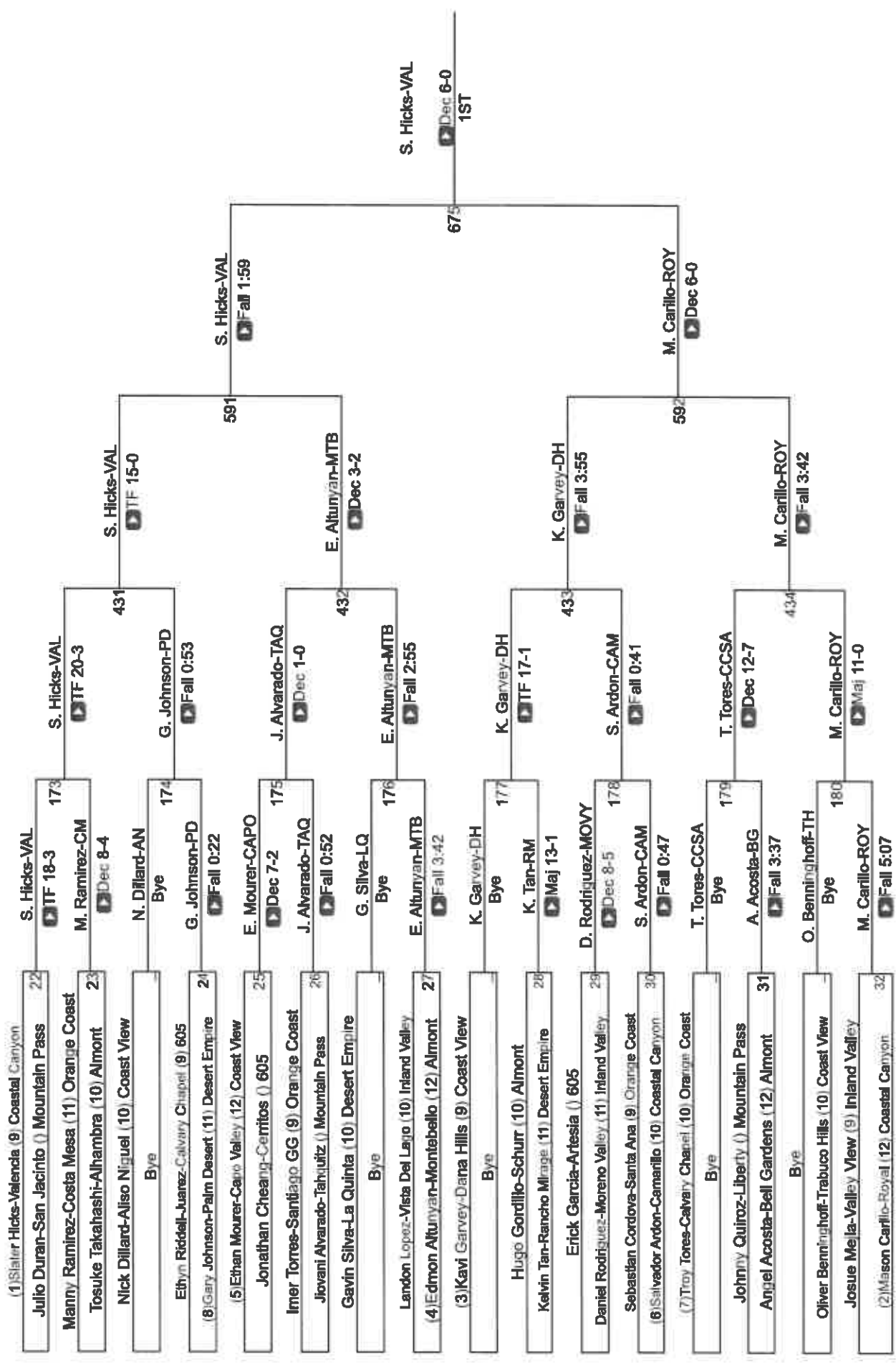

EIF Qualifier 120

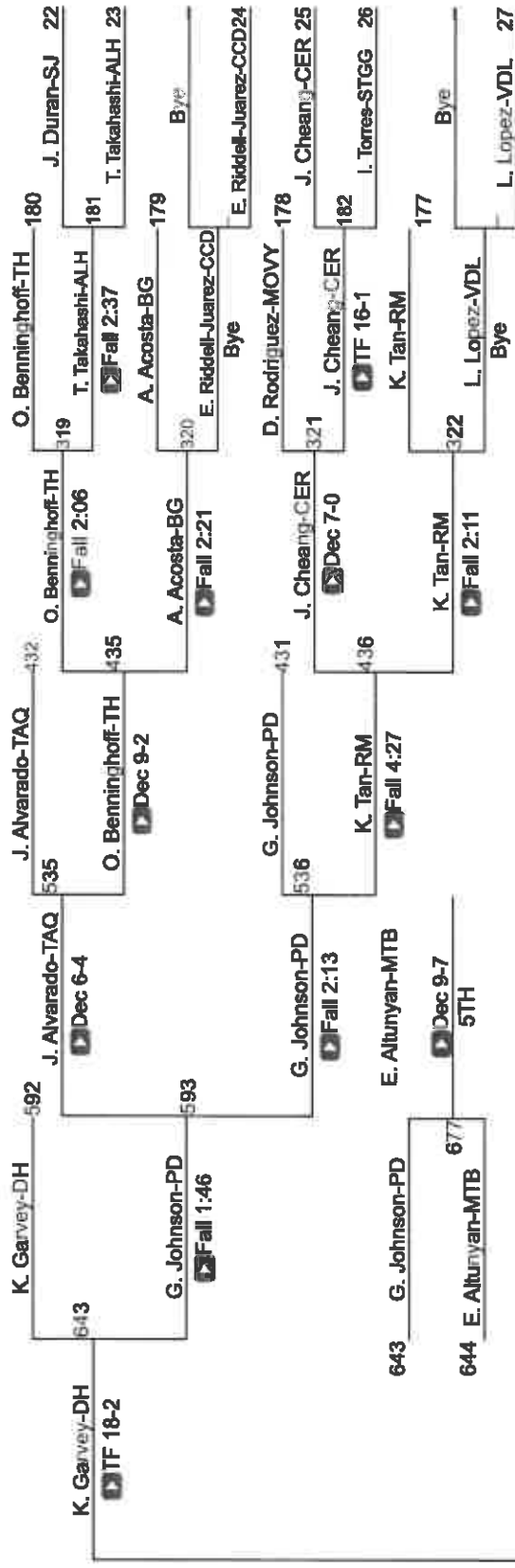

K. Garvey-DH

Fall 2:18

3RD

CIF SS Boys Individuals Eastern Div

CIF Qualifier 126

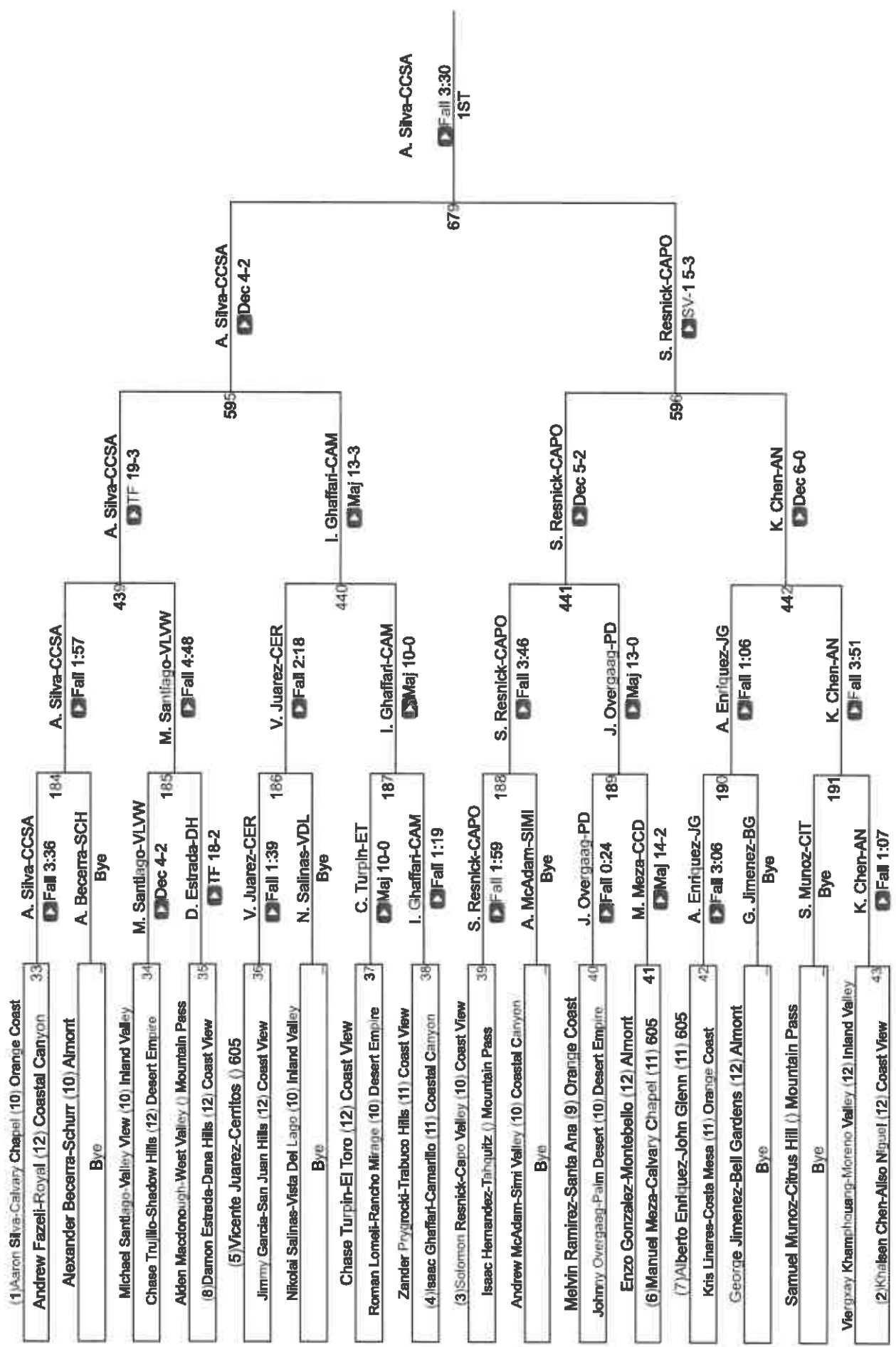

CIF Qualifier 126

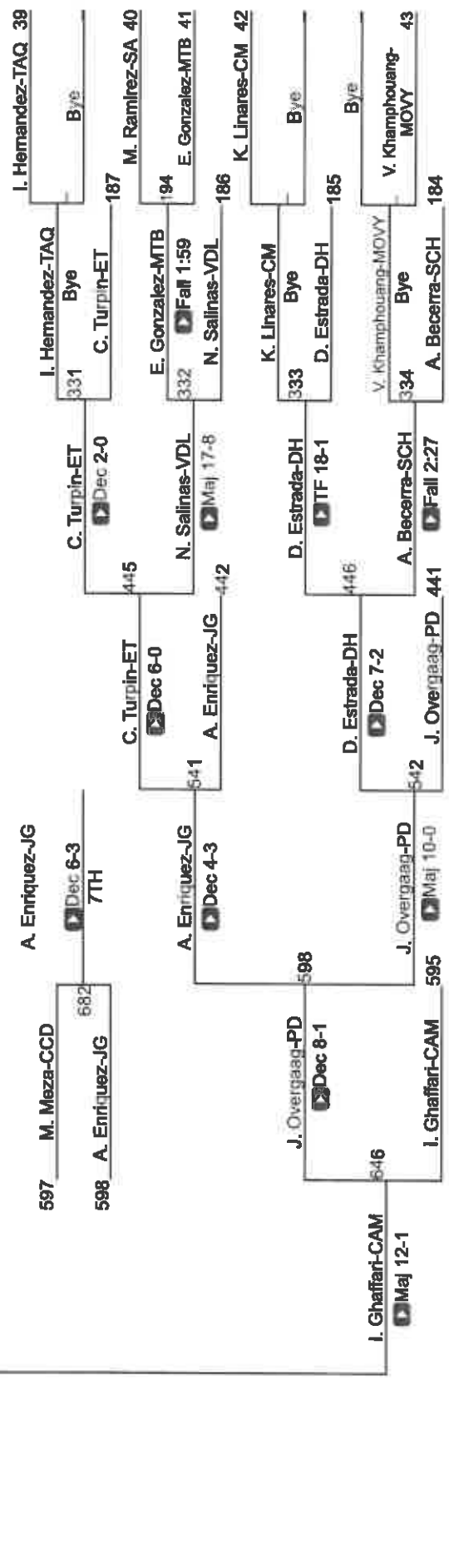
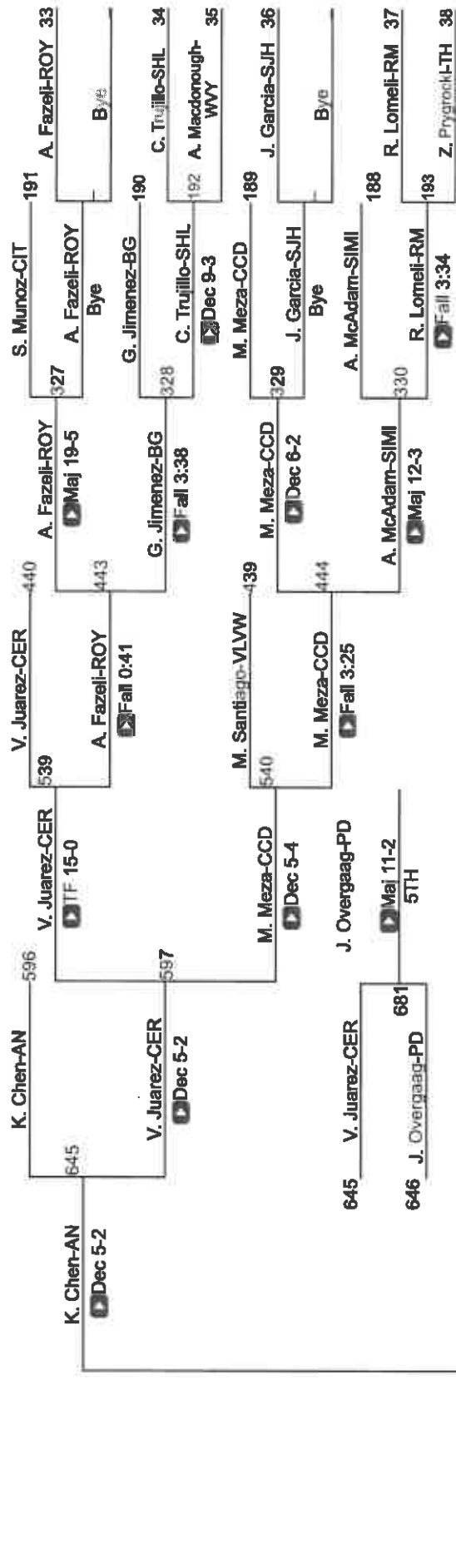

EIF SS Boys Individuals Eastern Div

EIF Qualifier 132

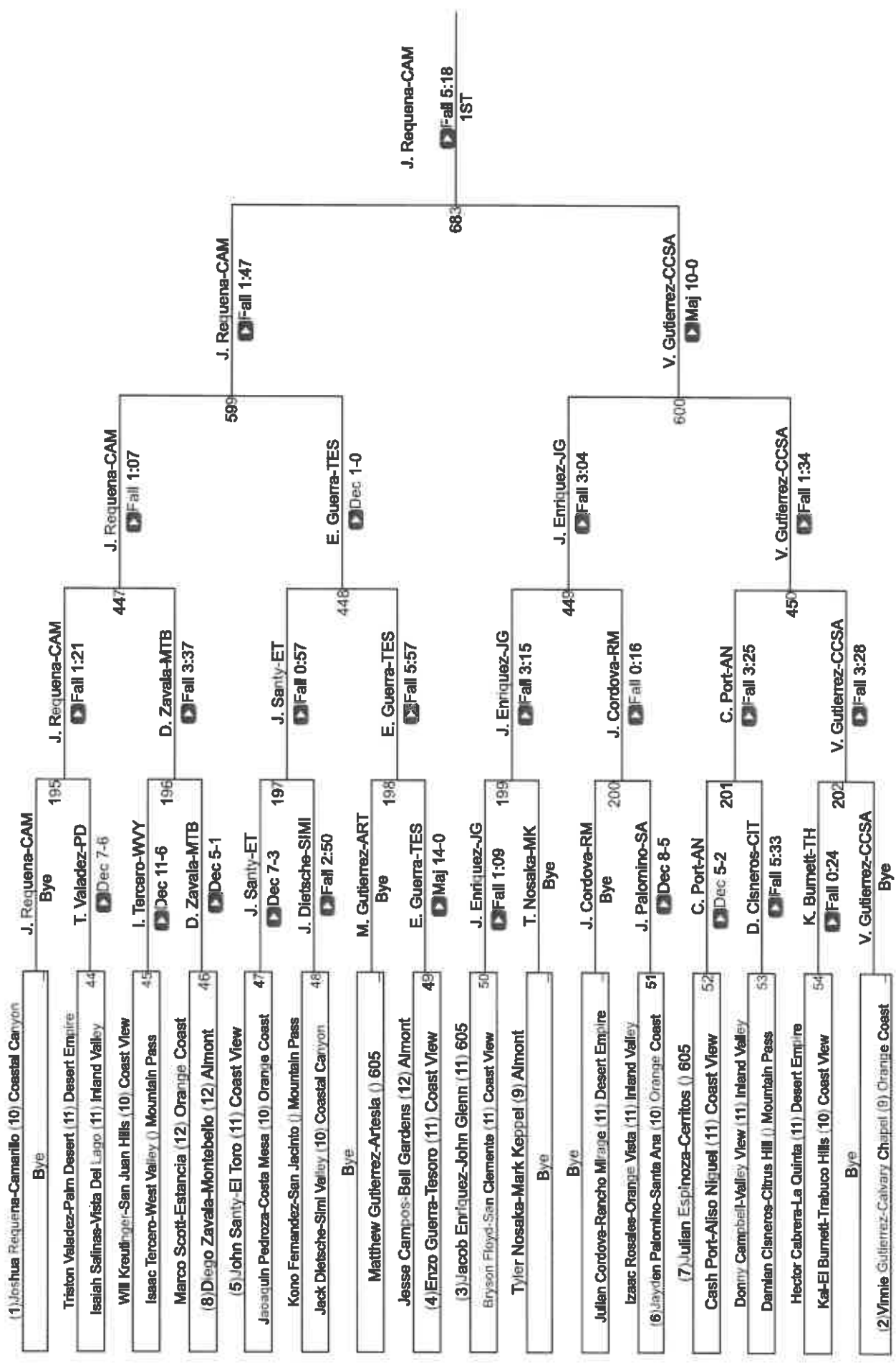

CIF Qualifier 132

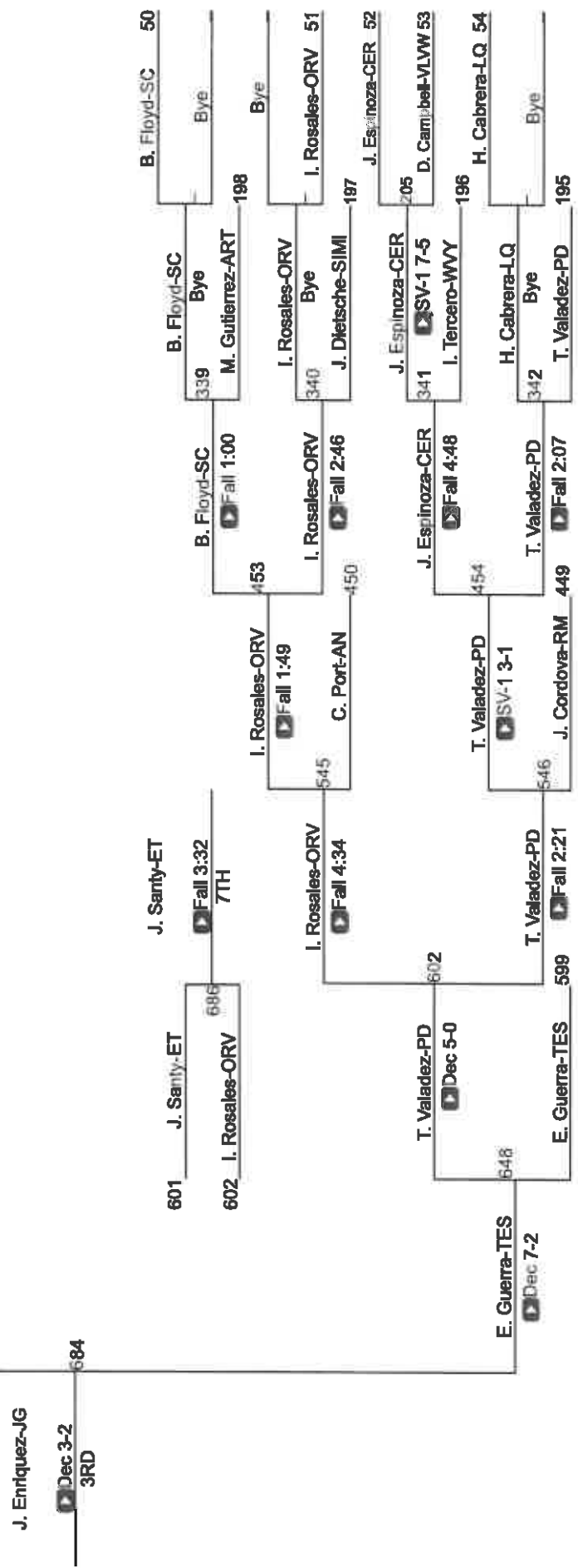
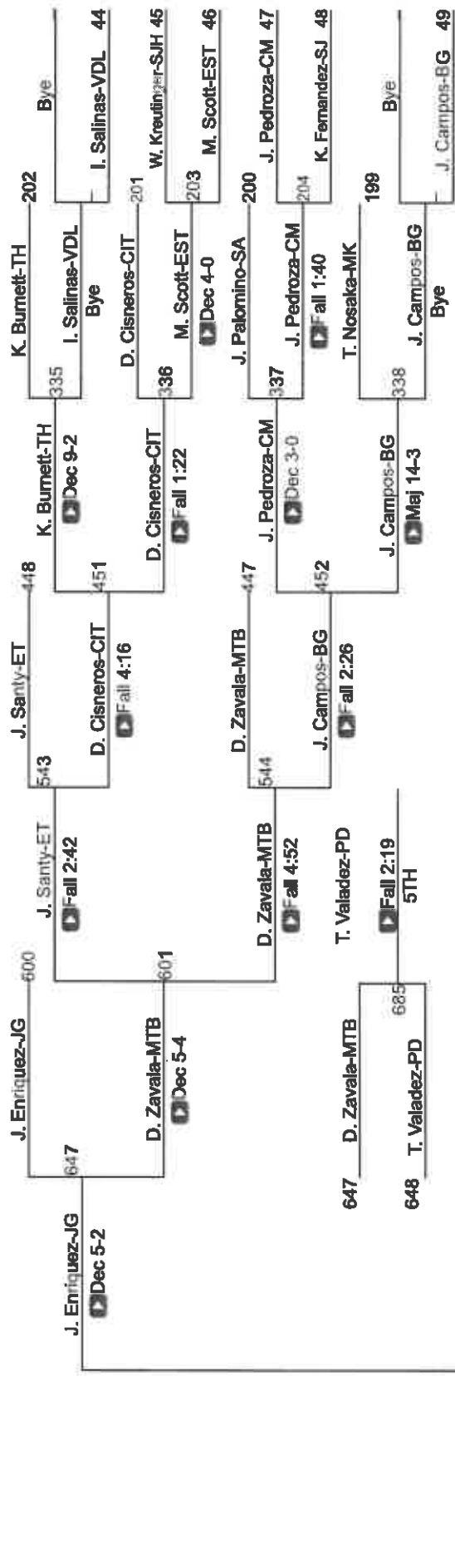

EIF SS Boys Individuals Eastern Div

EIF Qualifier 138

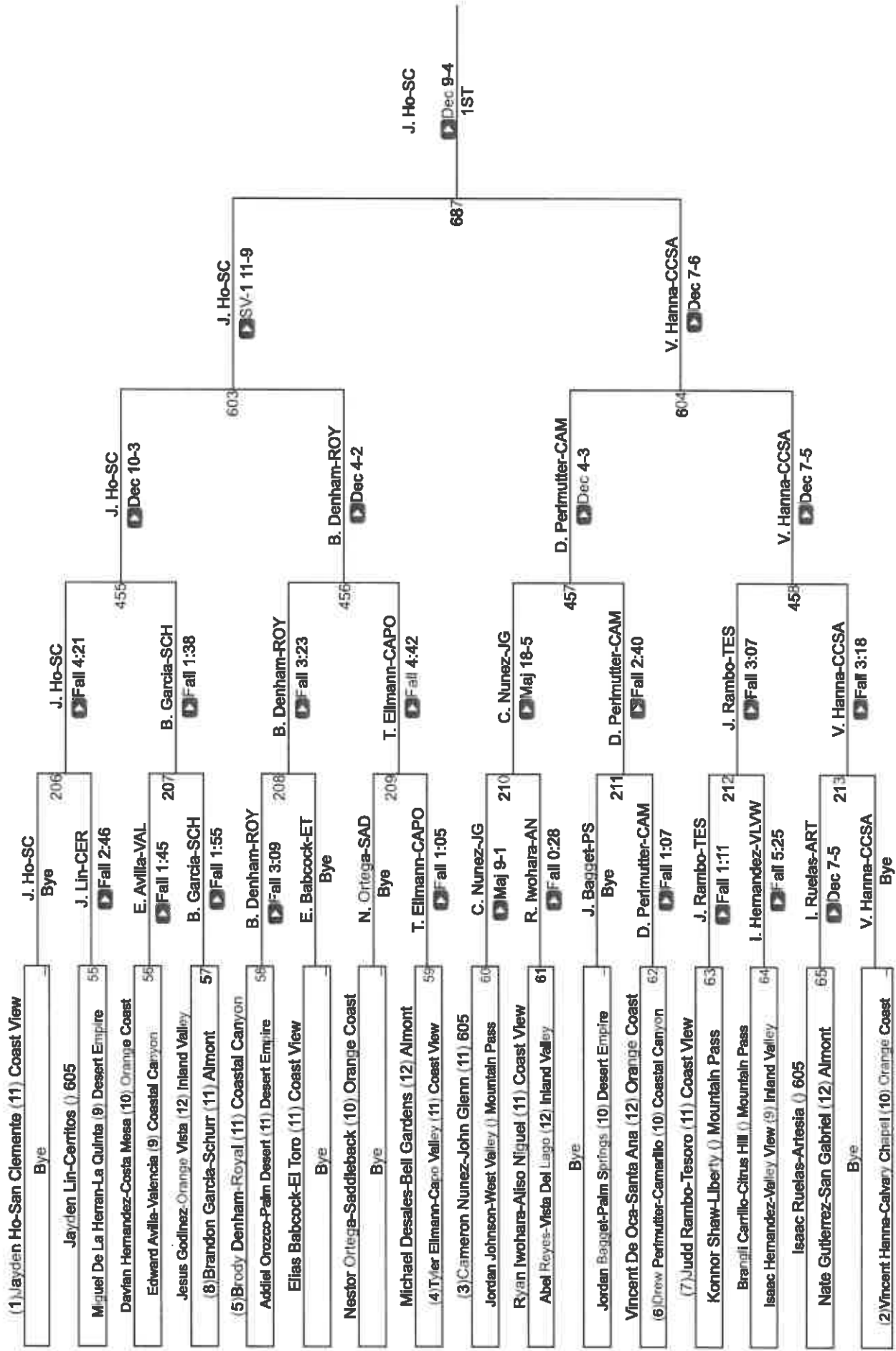

EIF Qualifier 138

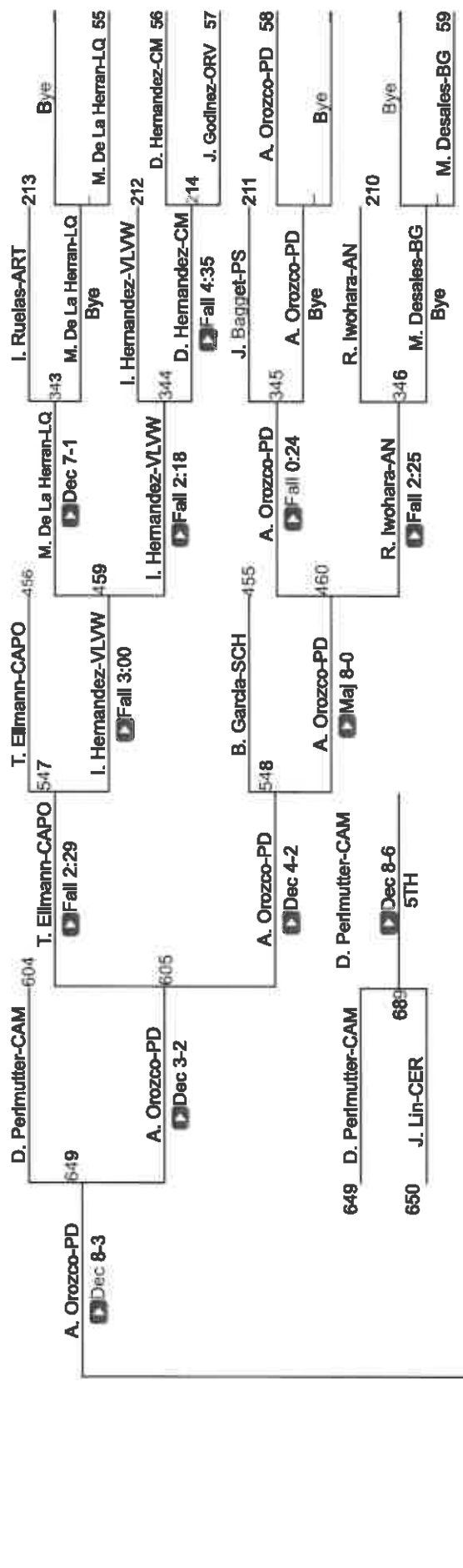

B. Denham-ROY
Dec 2-1
3RD

688

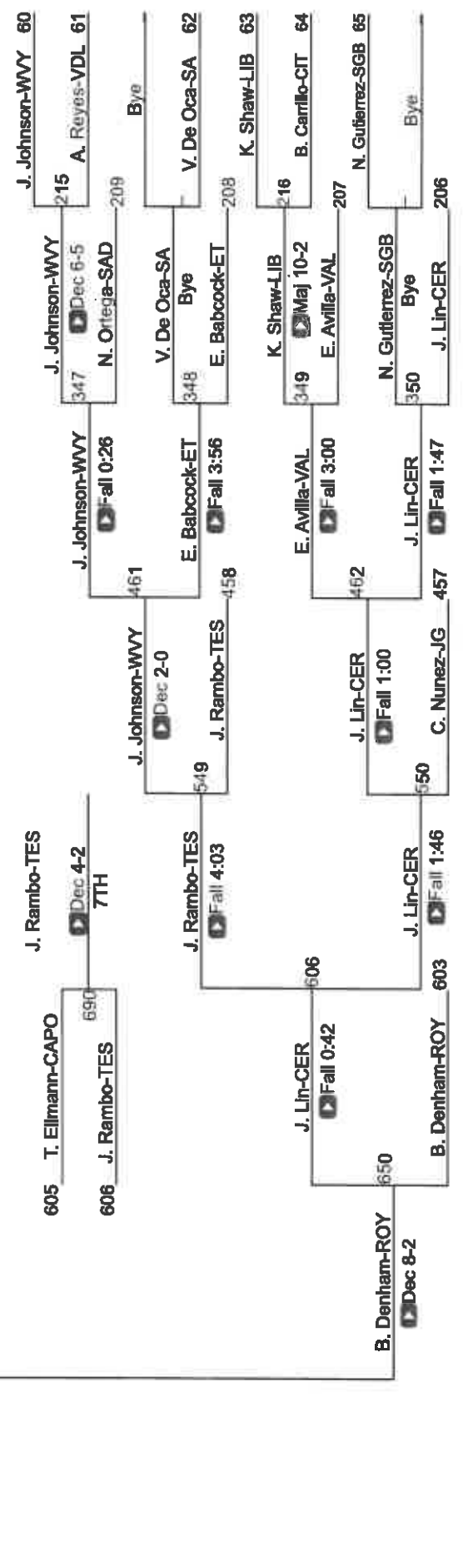

B. Denham-ROY
Dec 8-2

EIF SS Boys Individuals Eastern Div

EIF Qualifier 144

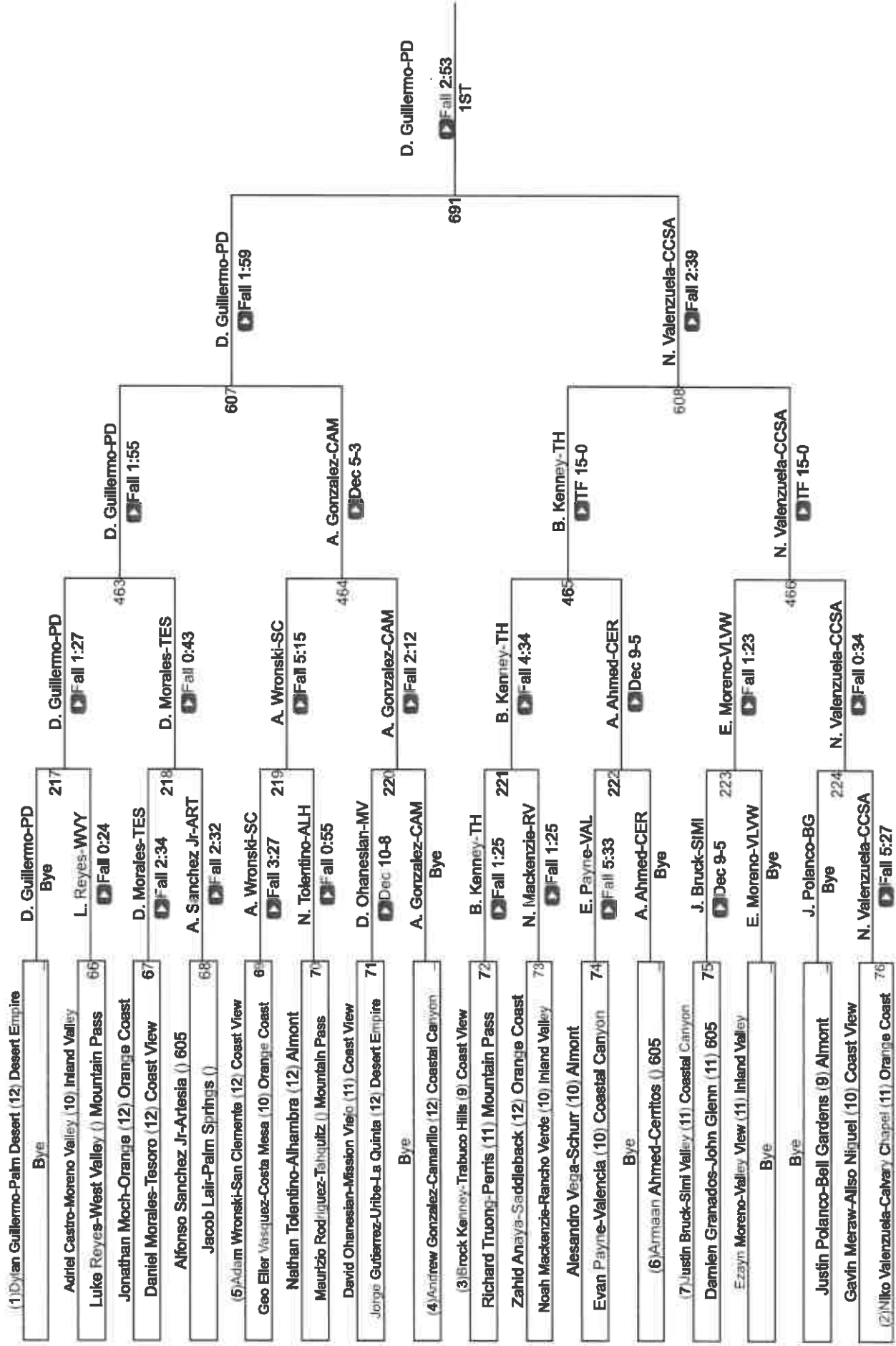

CIF Qualifier 144

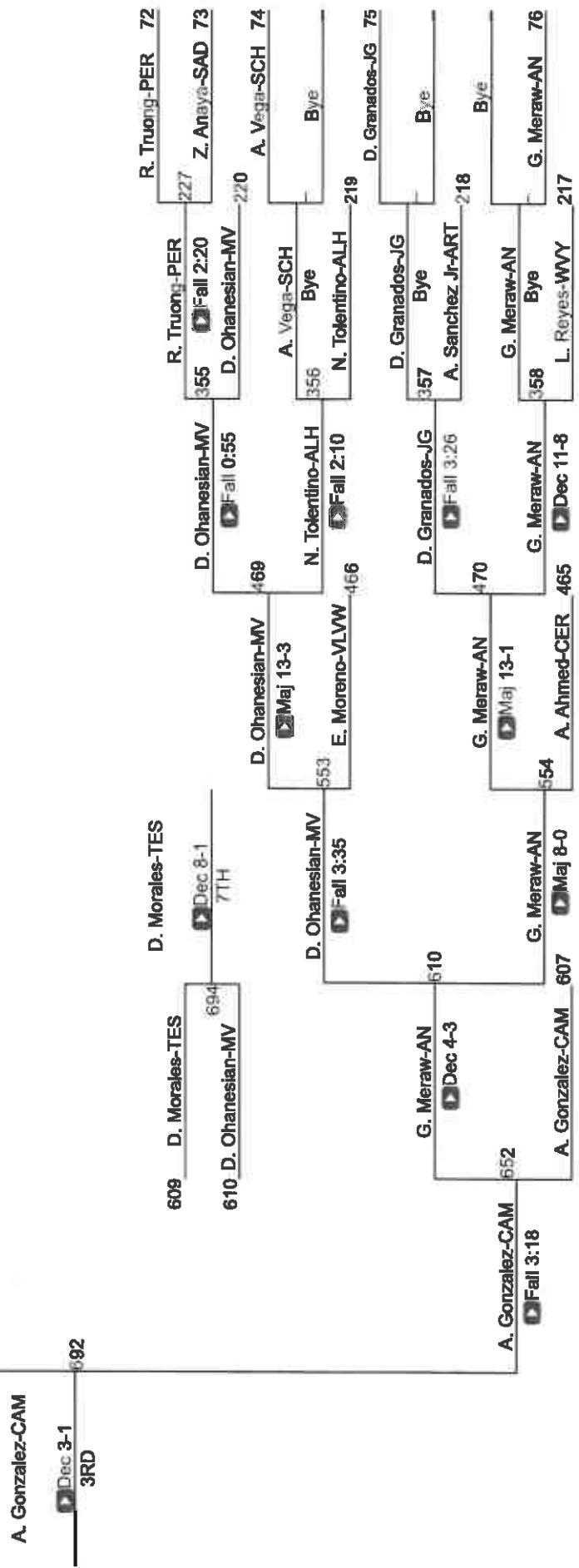
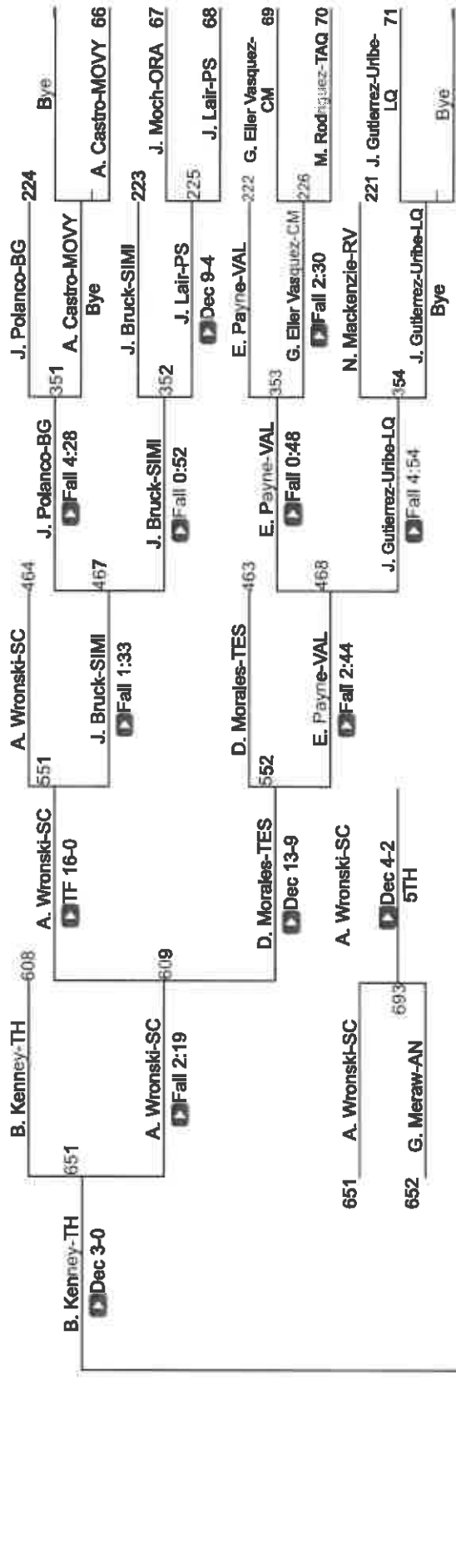

EIF SS Boys Individuals Eastern Div

EIF Qualifier 150

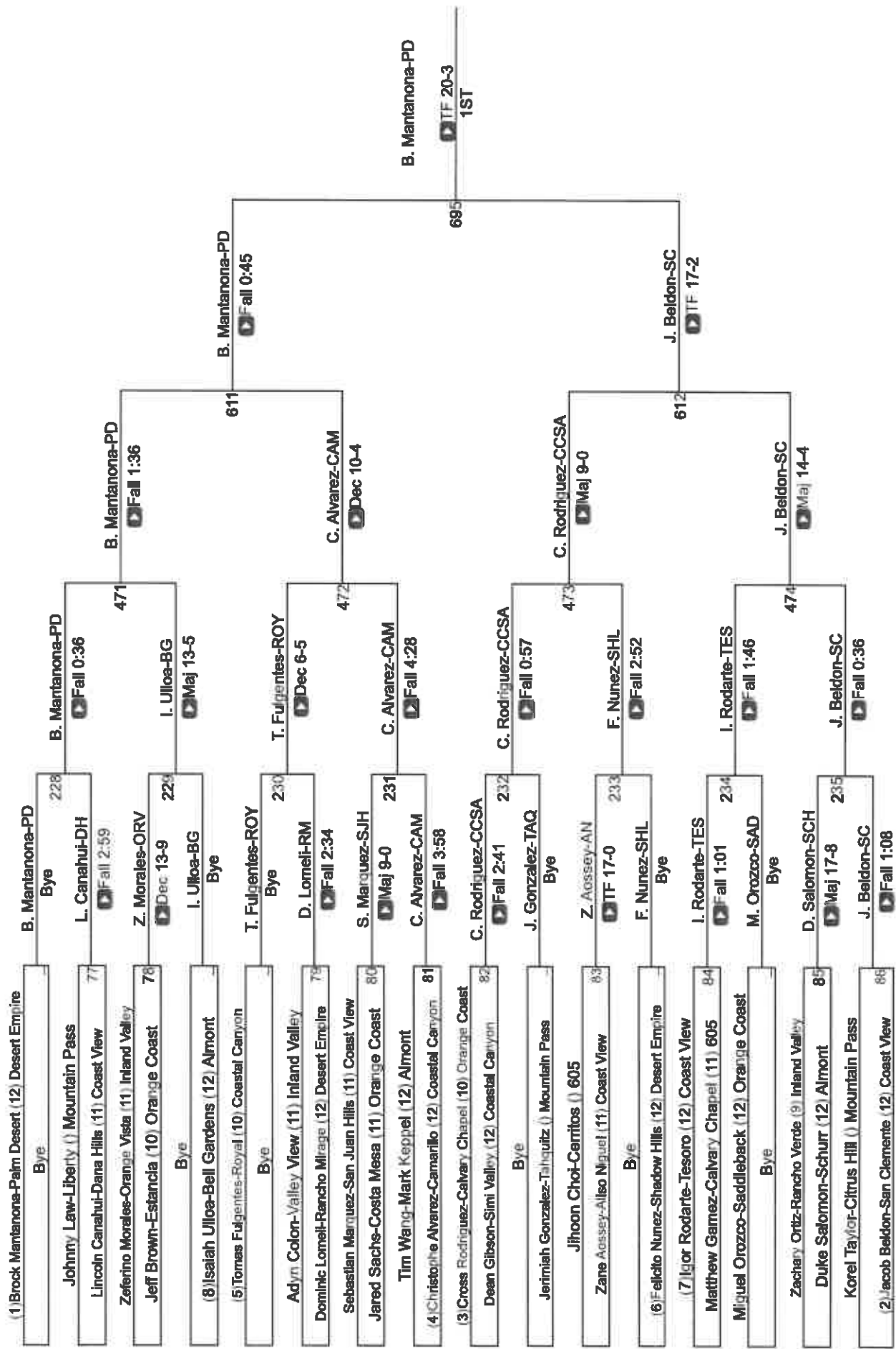

EIF Qualifier 150

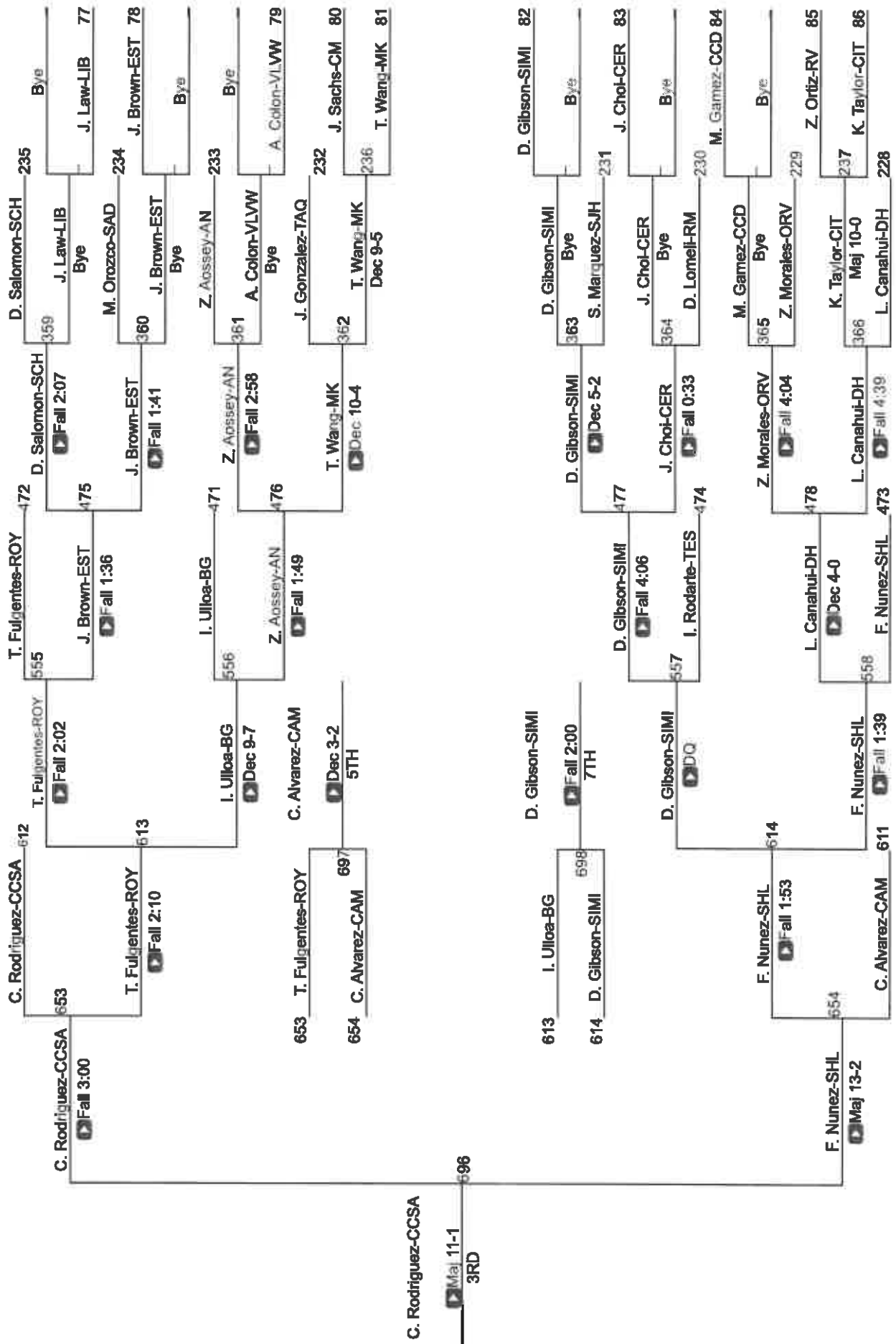

CIF SS Boys Individuals Eastern Div

CIF Qualifier 157

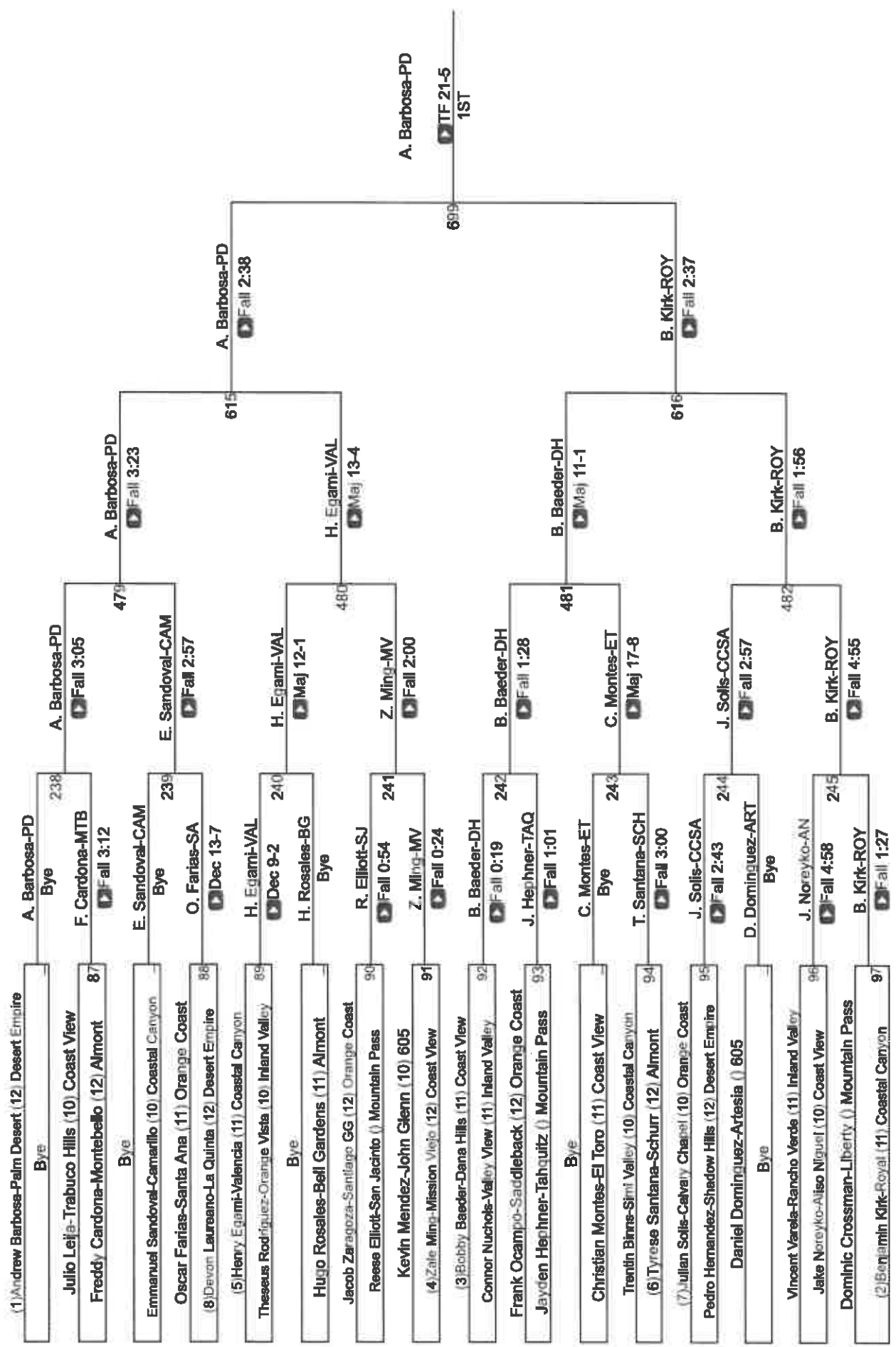

EIF Qualifier 157

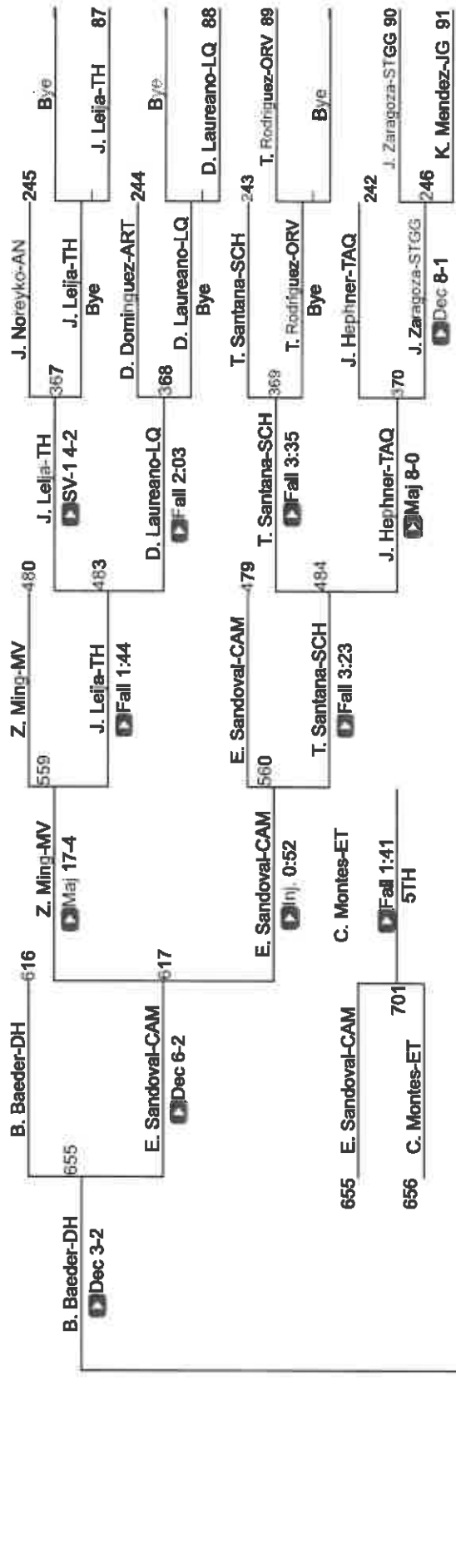

B. Baeder-DH

Fall 1:58
3RD

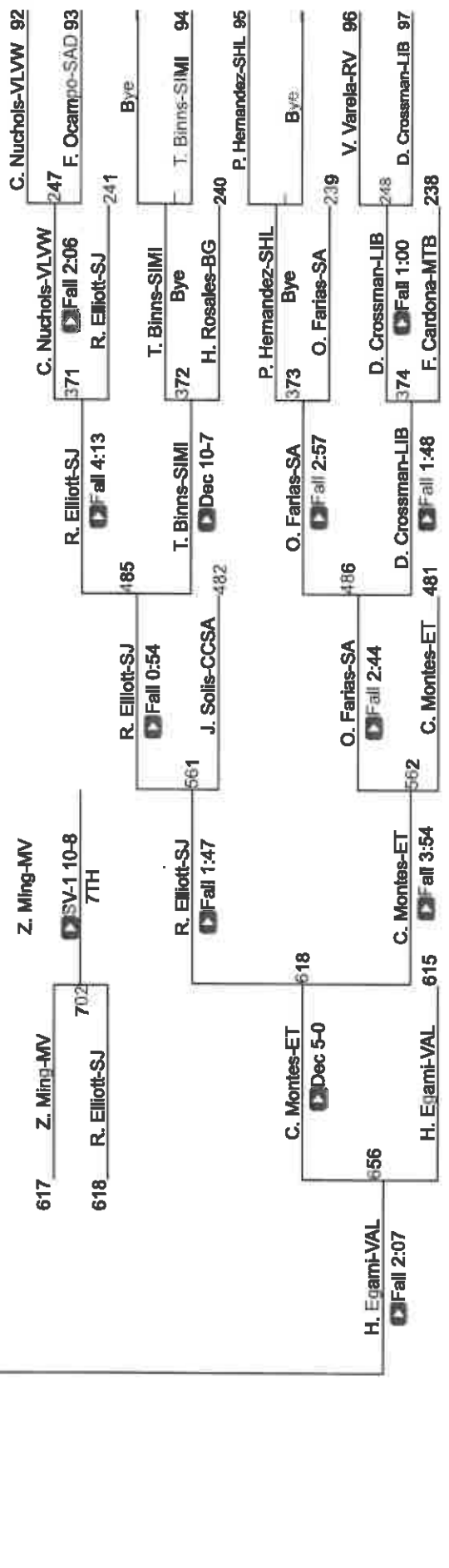

C. Nuchols-VLVW

Fall 1:58
3RD

EIF SS Boys Individuals Eastern Div

EIF Qualifier 165

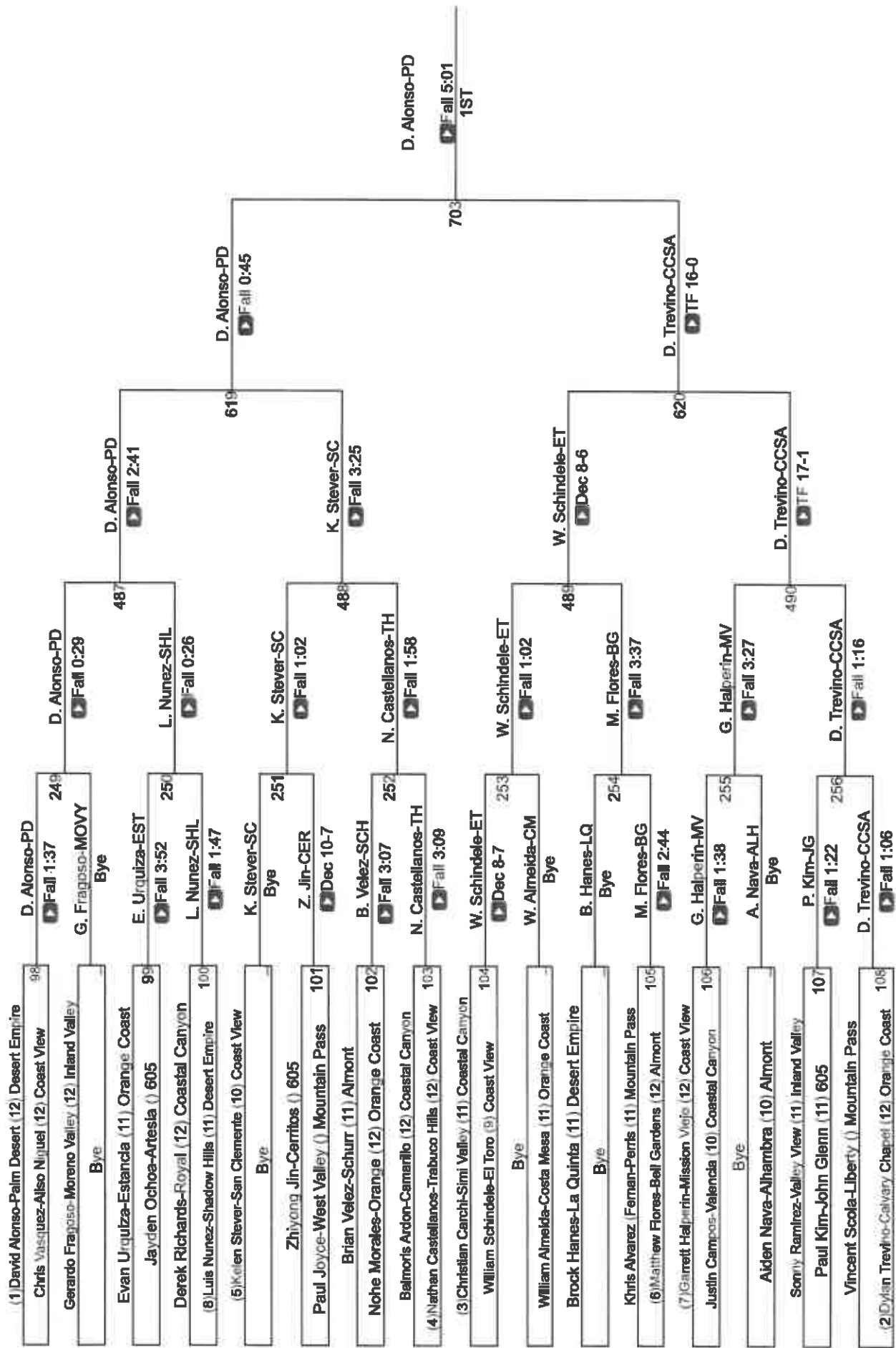

CIF Qualifier 165

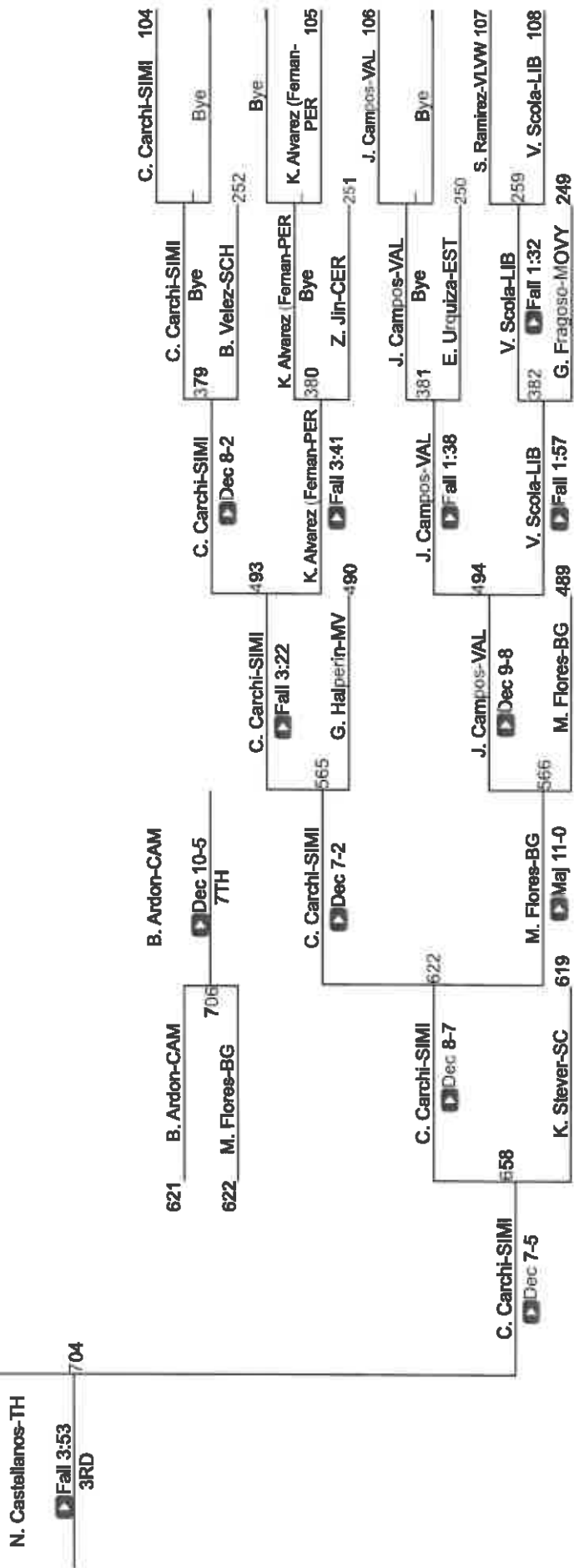
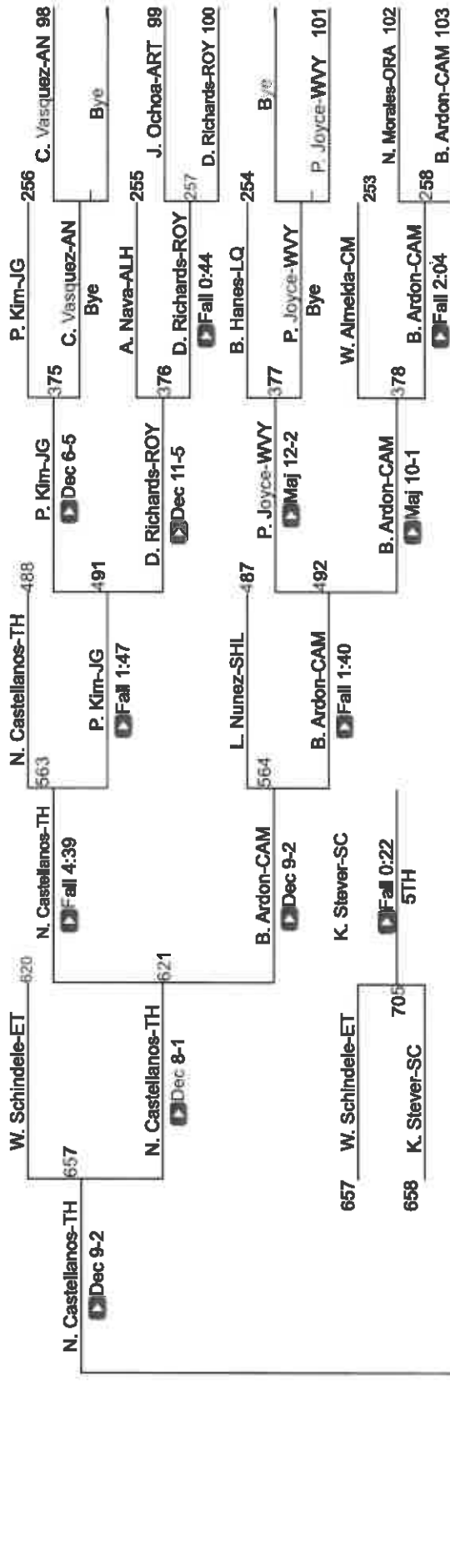

EIF SS Boys Individuals Eastern Div

EIF Qualifier 175

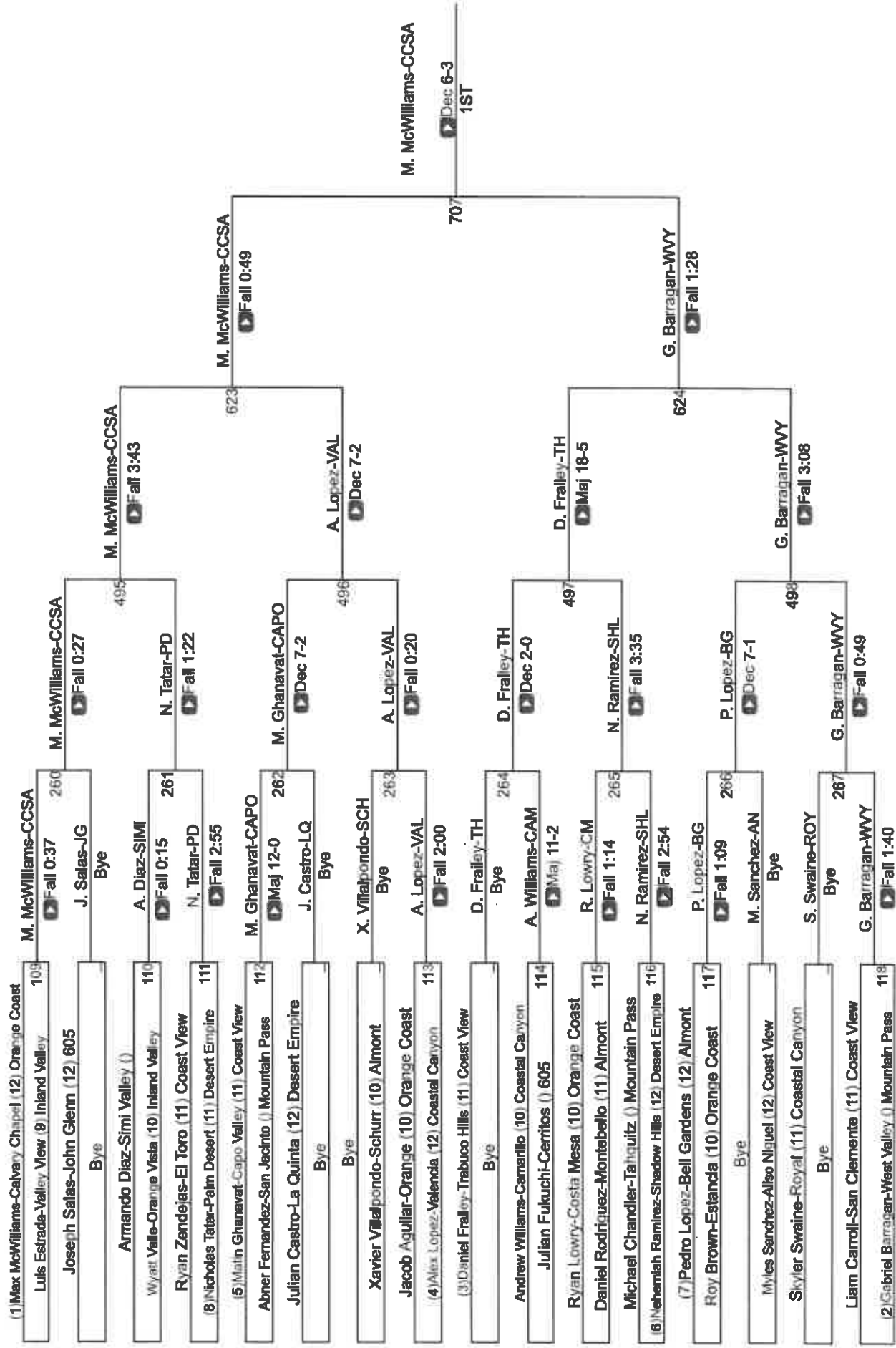

CIF Qualifier 175

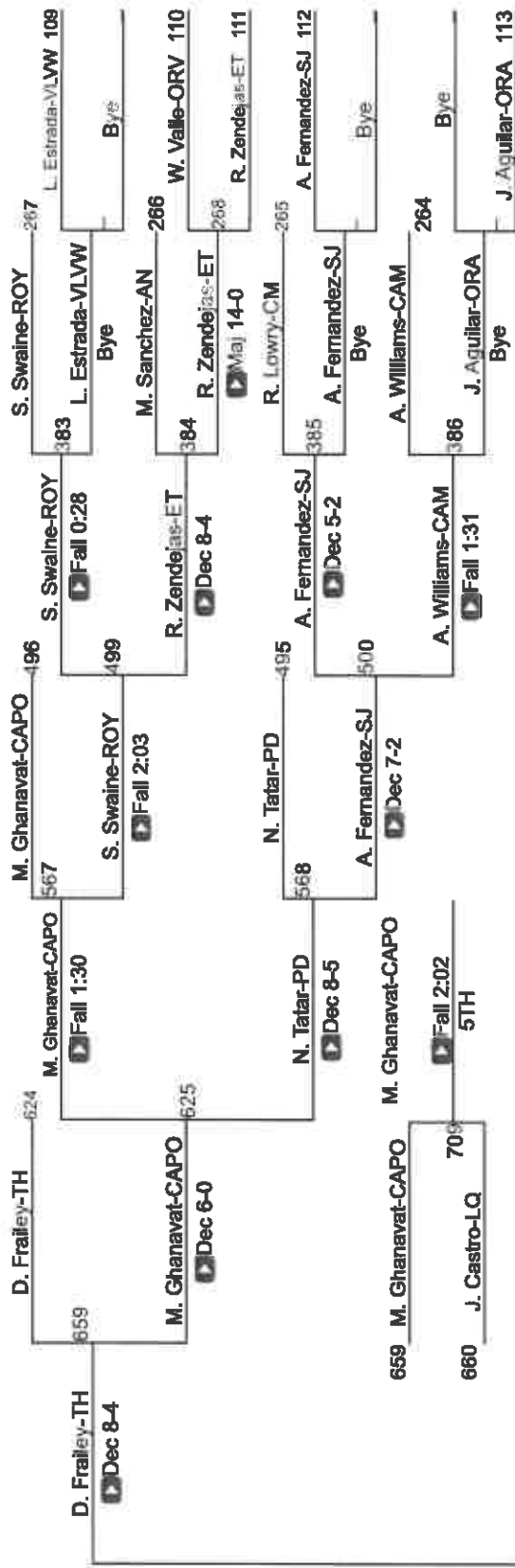

A. Lopez-VAL

Dec 10-4
3RD

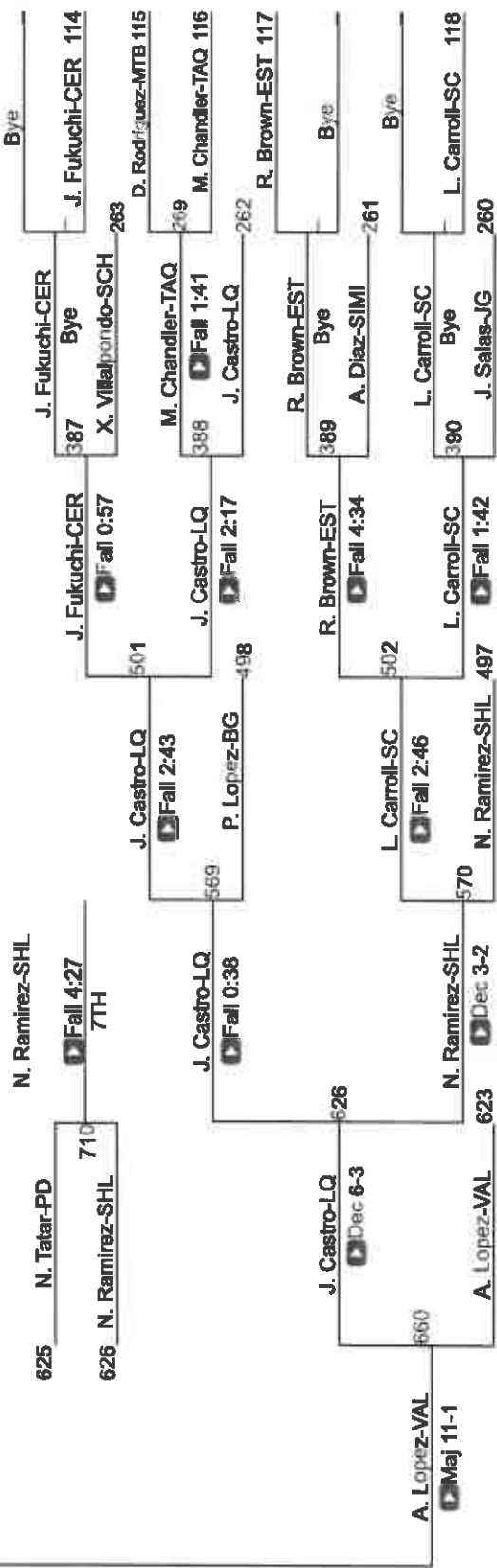

A. Lopez-VAL

Dec 10-4
3RD

CIF SS Boys Individuals Eastern Div

CIF Qualifier 190

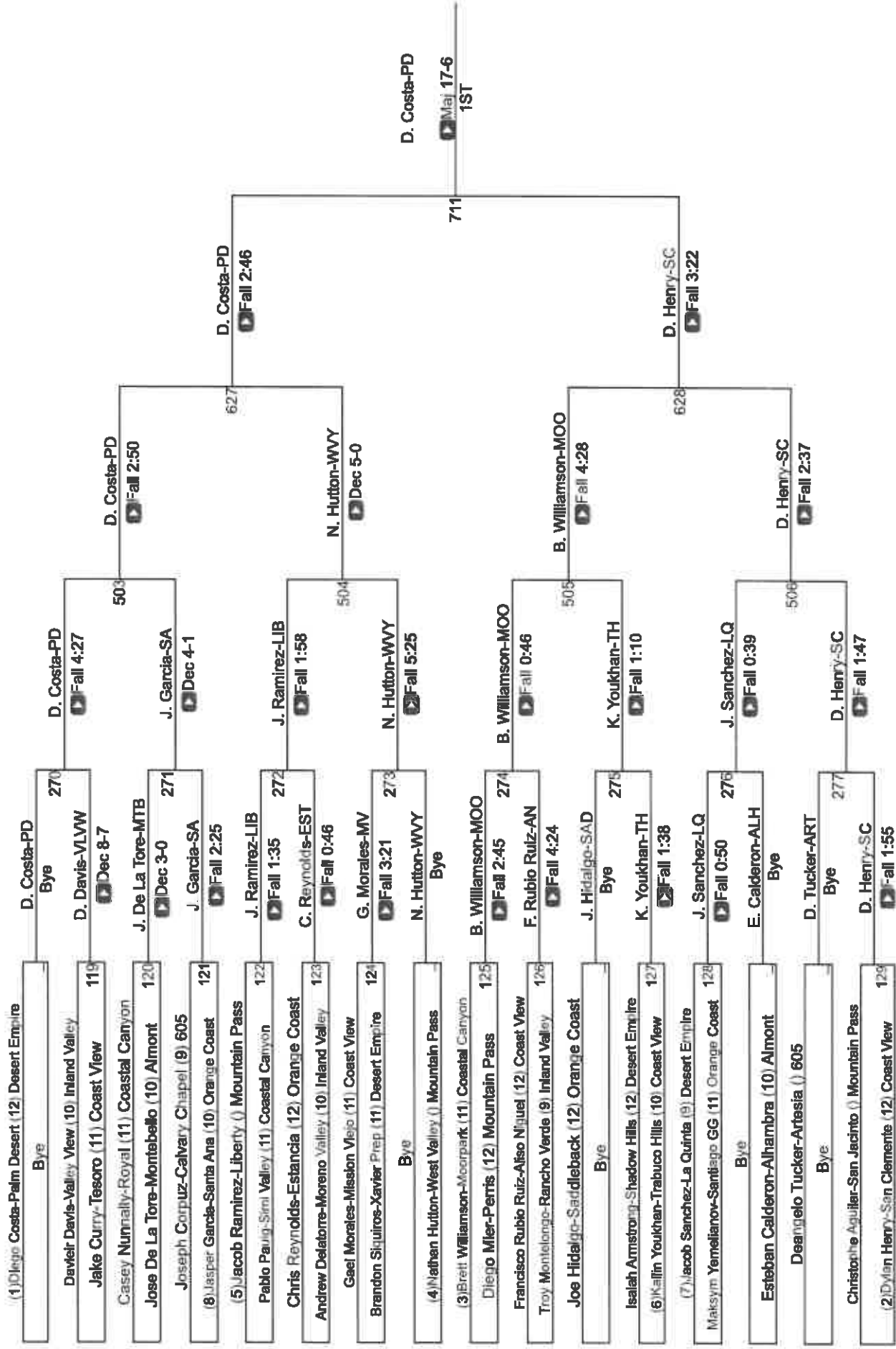

EIF Qualifier 190

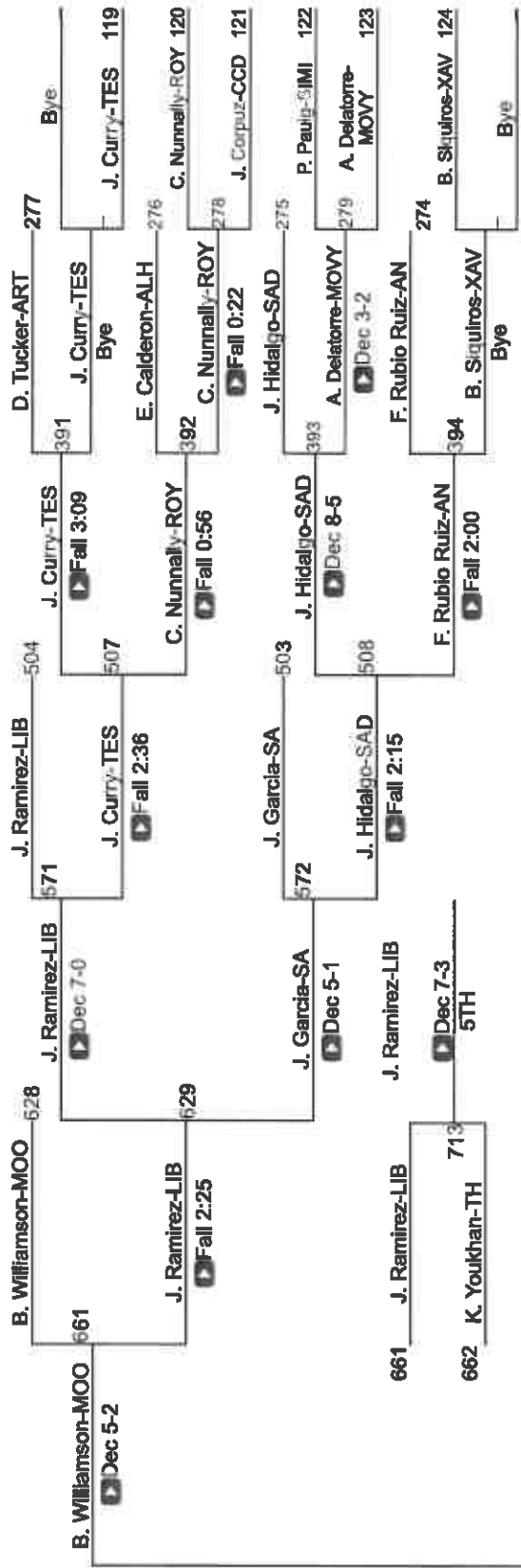

B. Williamson-MOO

▶ Dec 12-5
3RD

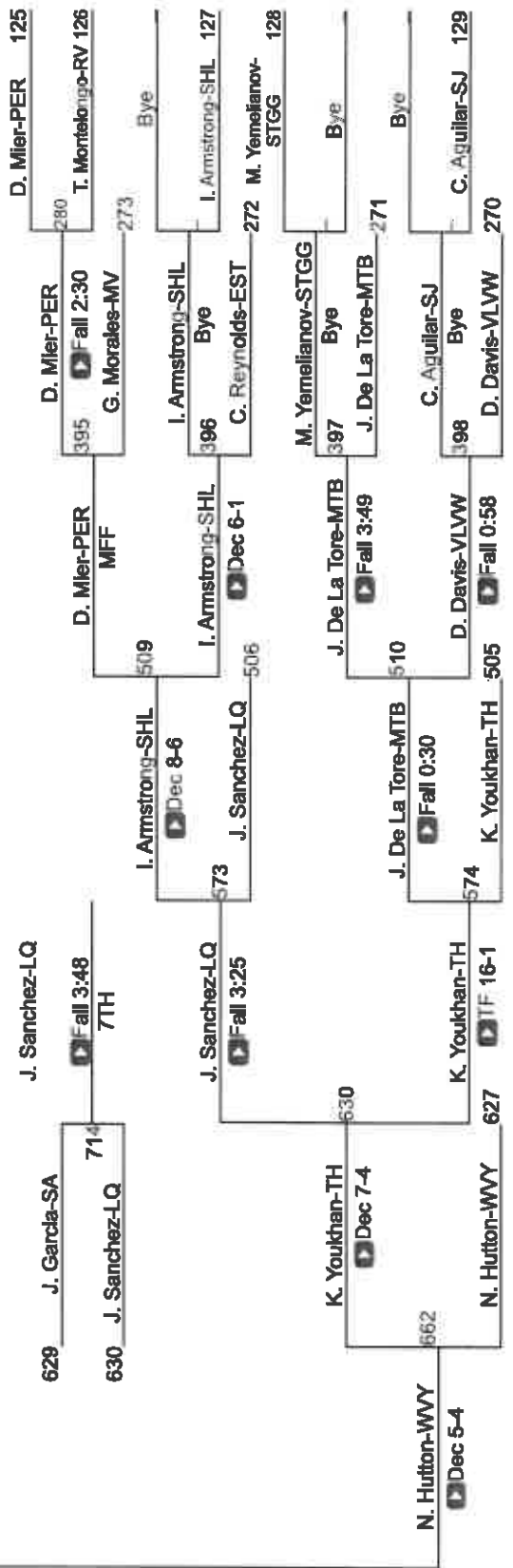

CIF SS Boys Individuals Eastern Div

CIF Qualifier 215

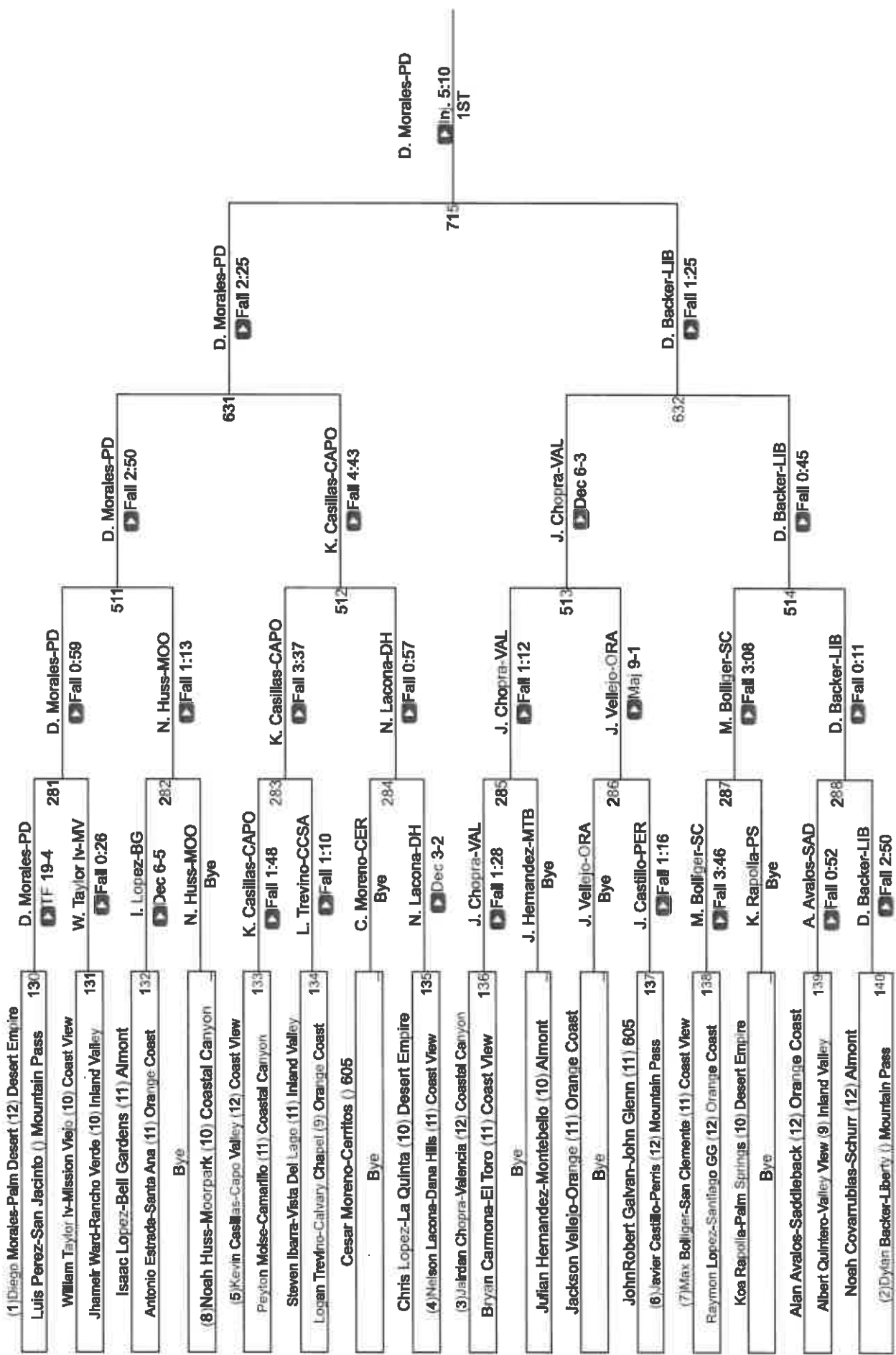

CIF Qualifier 215

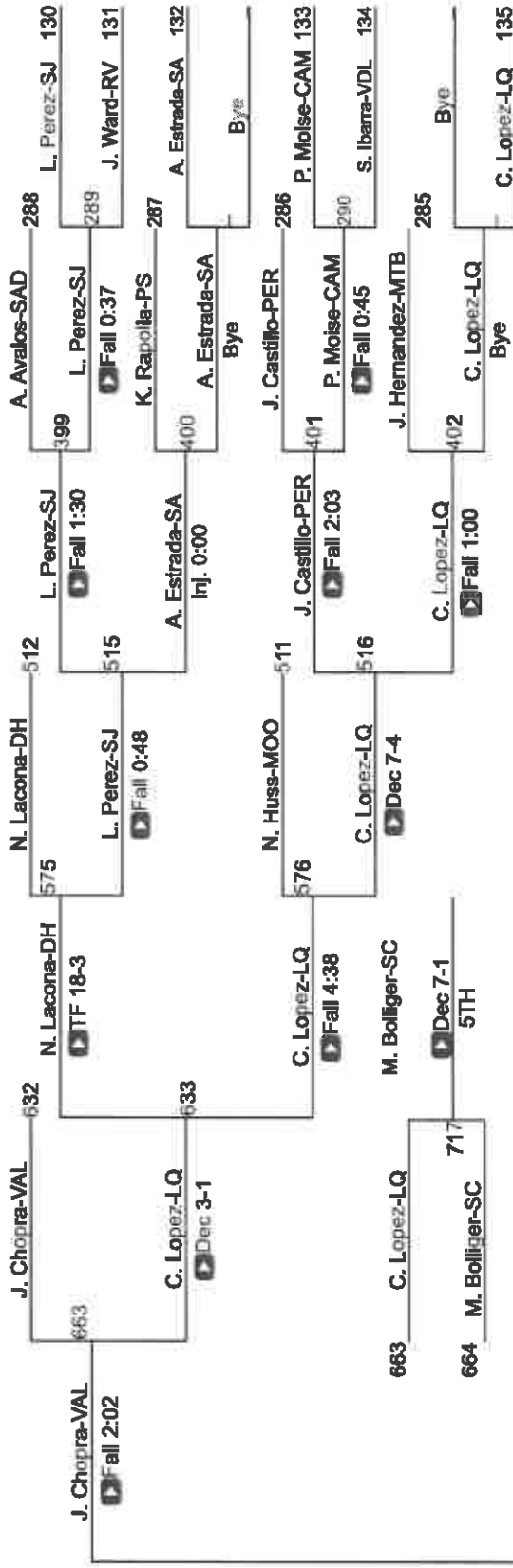

K. Casillas-CAPO

Fall 2:01
3RD

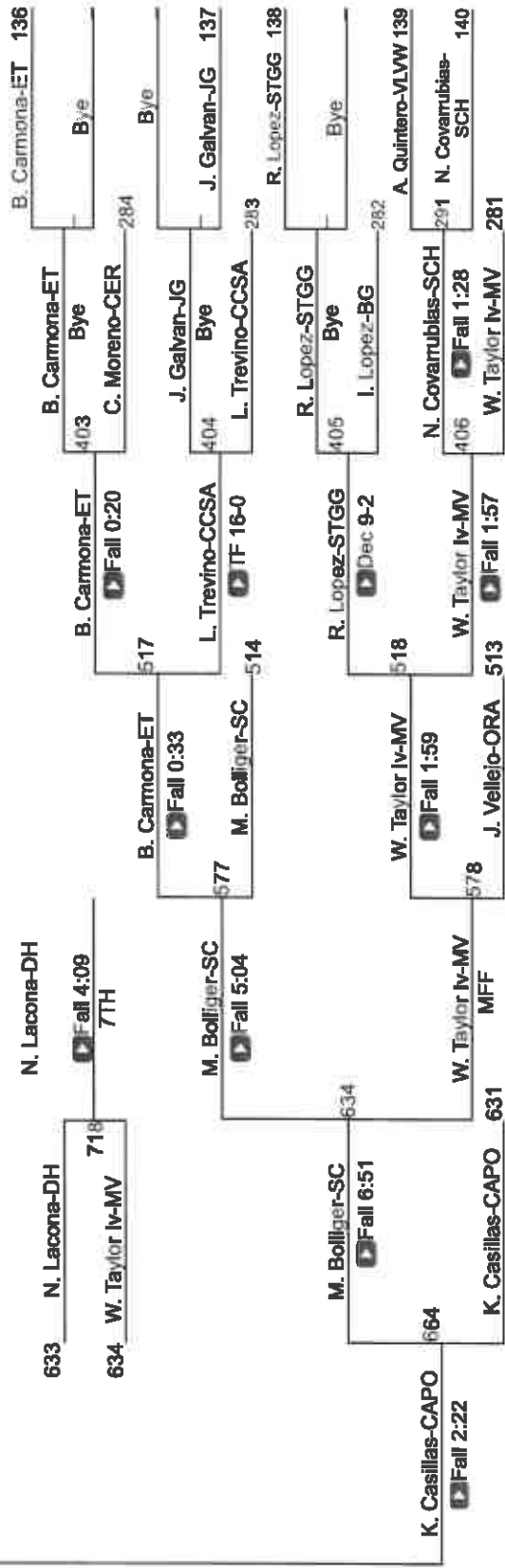

K. Casillas-CAPO
Fall 2:22

664

M. Bolliger-SC
Fall 6:51

578

W. Taylor IV-MV

518

W. Taylor IV-MV

513

516

517

514

515

512

511

510

509

508

507

506

505

EIF SS Boys Individuals Eastern Div

EIF Qualifier 285

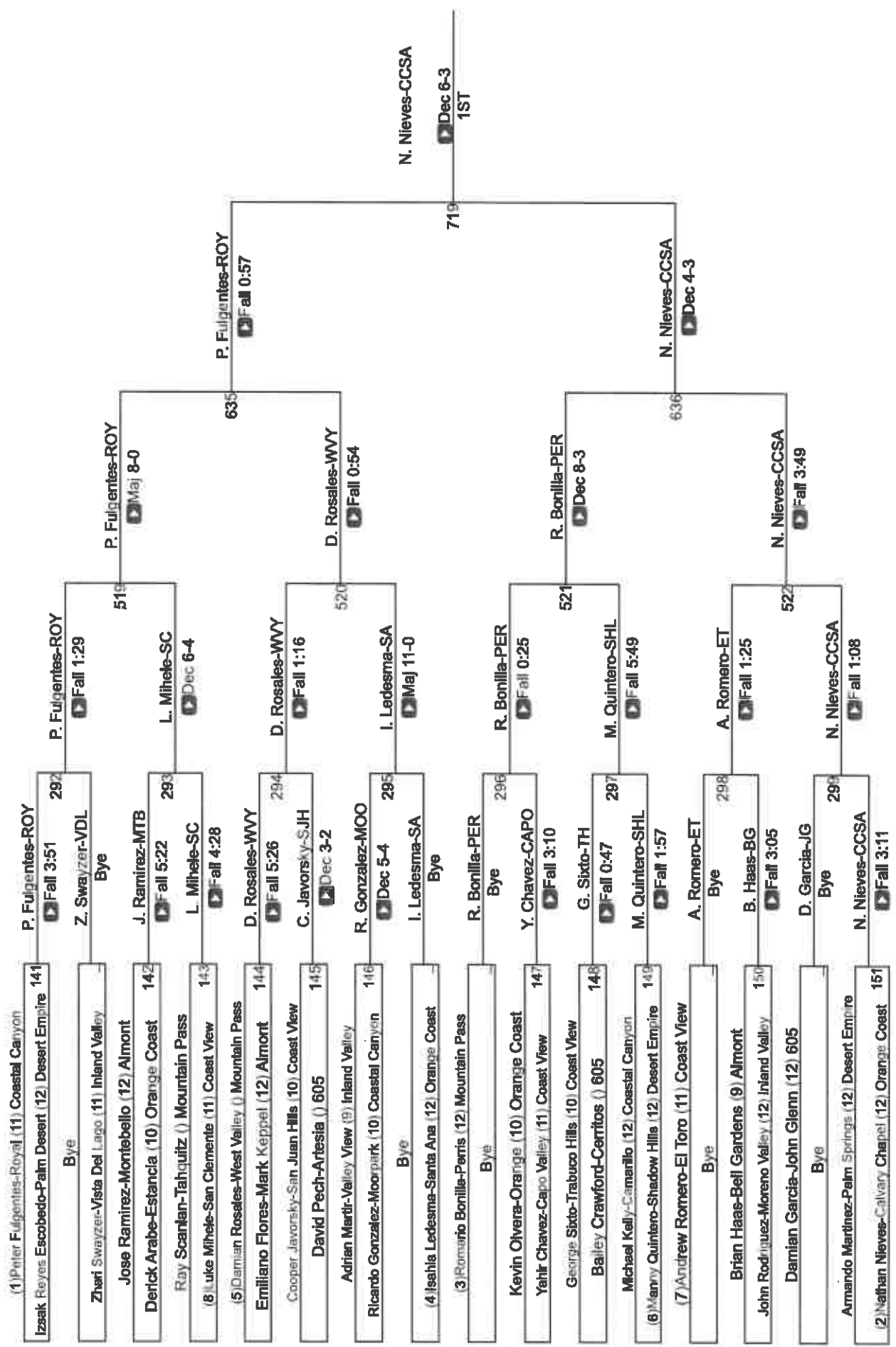

CIF Qualifier 285

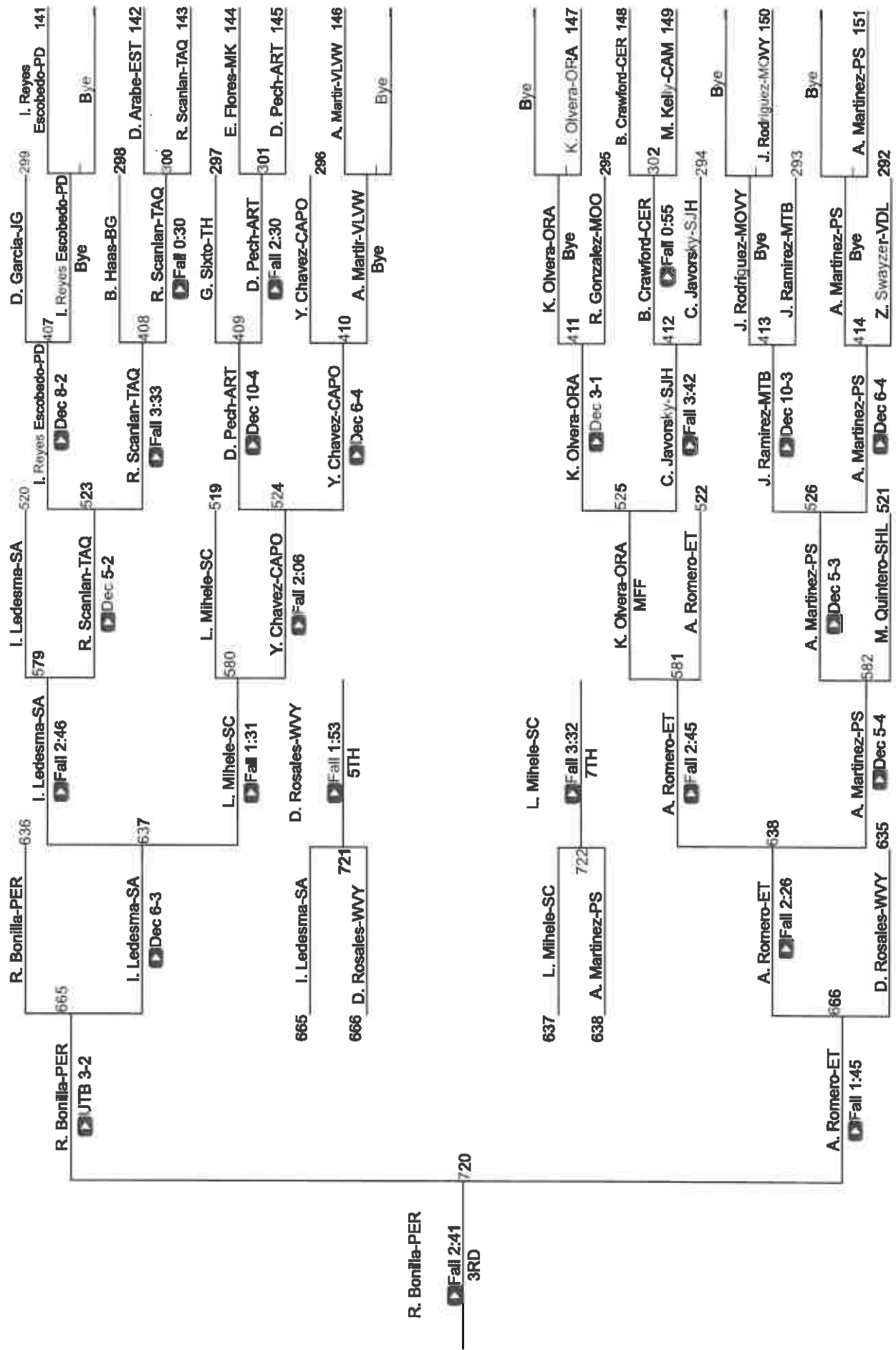

CIF SS Boys Individuals

Inland Division

Fountain Valley High School

February 9-10, 2024



Lower Weight MVP

Hunter Jauregul
Fountain Valley
106 Pounds

Upper Weight MVP

Ryland Whitworth
Fountain Valley
215 Pounds

Placers

108 Pounds		
1st	Hunter Jauregul	Fountain Valley
2nd	Zachary Southern	Hesperia
3rd	Daniel Mendoza	Victor Valley
4th	Rikki Villaseñor	Newport Harbor
5th	Logann Ruiz	Los Alamitos
6th	Gevin Equihua	Arlington
7th	Chris Sautter	Big Bear
8th	Dylan Axe	Edison

113 Pounds		
1st	Paulo Valdez	Hesperia
2nd	Caol Humphrey	Sultana
3rd	Lucas Long	Arroyo
4th	Chris Qureshi	Fountain Valley
5th	Jackson Lawaky	Laguna Beach
6th	Cesar Sandoval	Victor Valley
7th	Tripp Saire	Edison
8th	Jp Gonthier	Laguna Hills

120 Pounds		
1st	Rocky Humphrey	Sultana
2nd	Cody Dalebout	Beckman
3rd	Brady Mercer	Fountain Valley
4th	Micah Van Grol	Newport Harbor
5th	Adam Davis	Hillcrest
6th	Tyler Mulford	Apple Valley
7th	Barron Zepeda	Laguna Beach
8th	Brian Castro	Victor Valley

126 Pounds		
1st	Anthony Lucio	Fountain Valley
2nd	Andrew Diaz	Hesperia
3rd	Denzel Cisneros	Sultana
4th	Jose Gullen	Victor Valley
5th	Damian Fajardo	Laguna Hills
6th	Graham DeSantis	Corona Del Mar
7th	Pablo Castelan	Granite Hills
8th	Ethan Carey	Los Alamitos

132 Pounds		
1st	Damian Pryima	Newport Harbor
2nd	Emiliano Hernandez	Hesperia
3rd	Gavvin Stephens	Huntington Beach
4th	Jimmy Loy	Fountain Valley
5th	Abdon Rodriguez	Barstow
6th	Isaac Tellez	Victor Valley
7th	Robert Cardoza	Excelsior Charter
8th	Isaac Benavidez	Marshall

138 Pounds		
1st	Hercules Windrath	Fountain Valley
2nd	Chris Guerrero	Hesperia
3rd	Matthew Pinon	Newport Harbor
4th	Samuel Yokoyama	Los Alamitos
5th	Nikita Sipachev	Laguna Hills
6th	Logan Pietilli	Huntington Beach
7th	Noah Villatoro	Sultana
8th	Brandon Chiang	Irvine

144 Pounds		
1st	Avian Singh	Victor Valley
2nd	Angel Selgado	Hesperia
3rd	Nathan Marquez	Fountain Valley
4th	James Kurcz	Corona Del Mar
5th	Adam Salas	Los Alamitos
6th	Seth Parry	Newport Harbor
7th	Jibril Sood	Laguna Hills
8th	Brandon Allen	Adelanto

150 Pounds		
1st	Anthony Manno	Newport Harbor
2nd	Christian Stoerber	Fountain Valley
3rd	Duardo Cruz	Victor Valley
4th	Porter Sharp	Corona Del Mar
5th	Zach Chacon	Laguna Hills
6th	Diego McDonald	Marshall
7th	Dominic Tomayo	Oak Hills
8th	Armaan Nikoo	Irvine

157 Pounds		
1st	Antonio Aramburu	Corona Del Mar
2nd	Noah Zotea	Fountain Valley
3rd	Amen Johnson	Laguna Hills
4th	Gabriel Garcia	Oak Hills
5th	Jacob Moreo	Los Alamitos
6th	Jose Rodriguez	Victor Valley
7th	Luke Chavez	Rosemead
8th	Trevor Bailey	Apple Valley

165 Pounds		
1st	Rocky Windrath	Fountain Valley
2nd	Jash Sandoval-Yell	Oak Hills
3rd	Alex Alfonso	Serrano
4th	Ayden Solomon	Newport Harbor
5th	Alexander Pichette	Portola
6th	Brayden Green	Burroughs
7th	Lorenzo Maddox	Woodbridge
8th	Siwon Shin	Marshall

175 Pounds		
1st	Zion Hernandez	Corona Del Mar
2nd	Hadi Hammoudeh	Irvine
3rd	Joseph Stevenson	Hesperia
4th	Jesse Cardona	Victor Valley
5th	Prince Norris	Adelanto
6th	Gavin Yager	Fountain Valley
7th	Calvin Welsh	University
8th	Ridge Lancaster	Marina

190 Pounds		
1st	Khale McDonnell	Fountain Valley
2nd	Eugenio Franco	Corona Del Mar
3rd	Achilles Violette	Patriot
4th	Asa Goff	Newport Harbor
5th	David Grannie-Vu	Northwood
6th	Slavaash Mavandadnejad	Irvine
7th	Owen Chlou	University
8th	Dane Holm	Hesperia

215 Pounds		
1st	Ryland Whitworth	Fountain Valley
2nd	Joseph Tierney	Irvine
3rd	Charles King	Oak Hills
4th	Makoa McCreadie	Woodbridge
5th	Anthony Leon	Corona Del Mar
6th	Daylen Bell	Adelanto
7th	Andrew Azadi	Laguna Hills
8th	Ricky Morales	Victor Valley

285 Pounds		
1st	Marcus Ochoa	Serrano
2nd	Jeremy Harris	Woodbridge
3rd	Aaron Candia	Hillcrest
4th	Xander Firm	Sultana
5th	Alejandro Reyes	Arroyo
6th	Kian Kaashkoolinia	Beckman
7th	Quentin Hunter	Barstow
8th	Raid Butler	Corona Del Mar

Team Score Final	
1	Fountain Valley 333
2	Hesperia 204
3	Newport Harbor 183
4	Victor Valley 173.5
5	Corona Del Mar 166
6	Sultana 127.5
7	Laguna Hills 111.5
8	Irvine 107
9	Oak Hills 98.5
10	Los Alamitos 86.5
11	Hillcrest 79.5
12	Arroyo 74
13	Adelanto 73
14	Woodbridge 60
15	Beckman 67
16	Serrano 57
17	Apple Valley 52
18	Marshall 50
19	Huntington Beach 49.5
20	Patriot 40
21	Portola 36.5
22	University 36.5
23	Barstow 36
24	Ramona 36
25	Laguna Beach 34
26	Edison 33
27	Excelsior Charter 28
28	Marina 25.5
29	Northwood 20.5
30	Big Bear 19
31	Burroughs 17
32	Granite Hills 17
33	Rosemead 17
34	Arlington 16.5
35	Gabrielino 14
36	Mountain View 13
37	Silverado 8
38	Norte Vista 6
39	Trinity Classical Academy 6
40	El Monte 4
41	South El Monte 2

CIF SS Boys Individuals Inland Div

CIF Qualifier 106

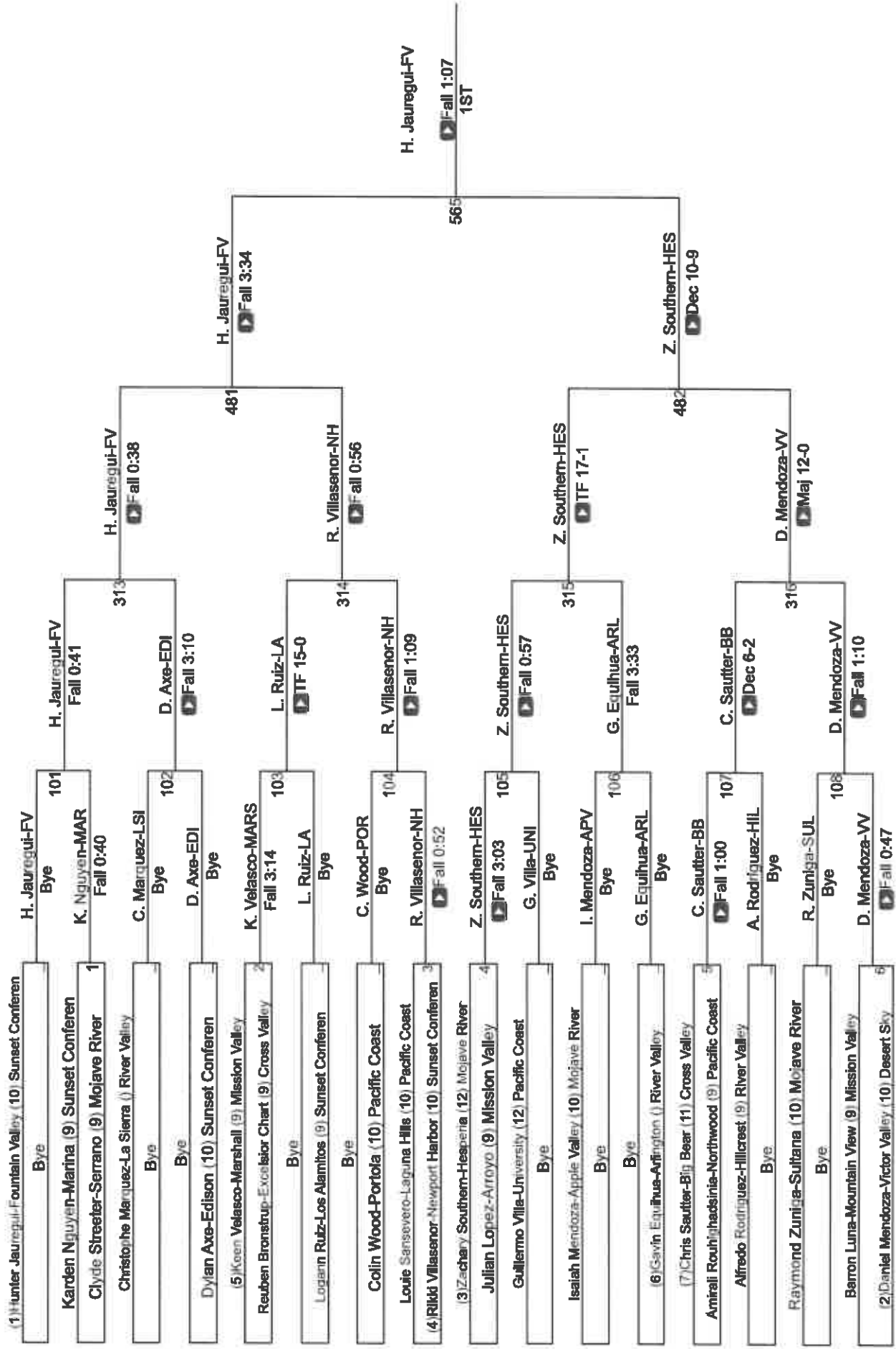

CIF Qualifier 106

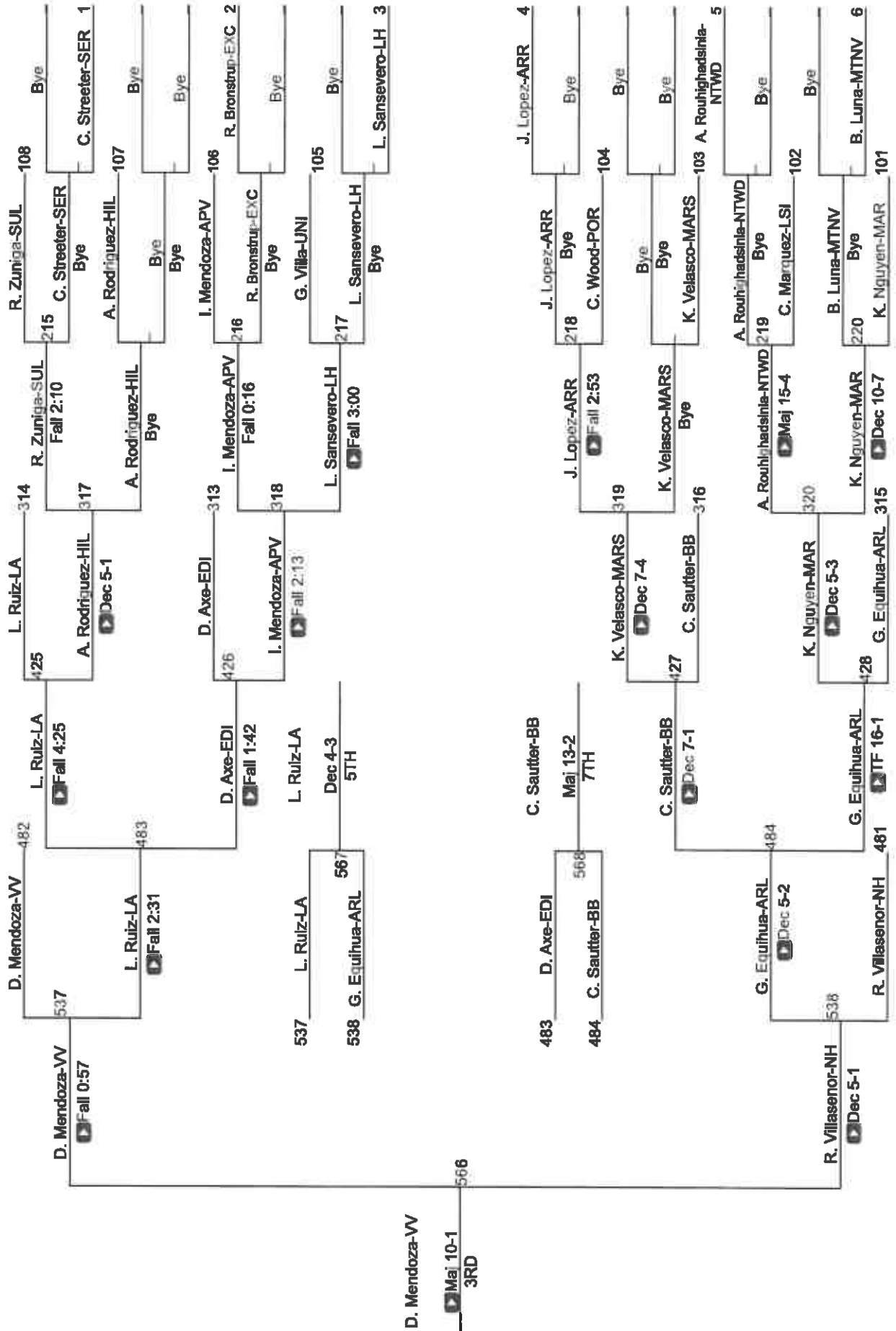

EIF SS Boys Individuals Inland Div

EIF Qualifier 113

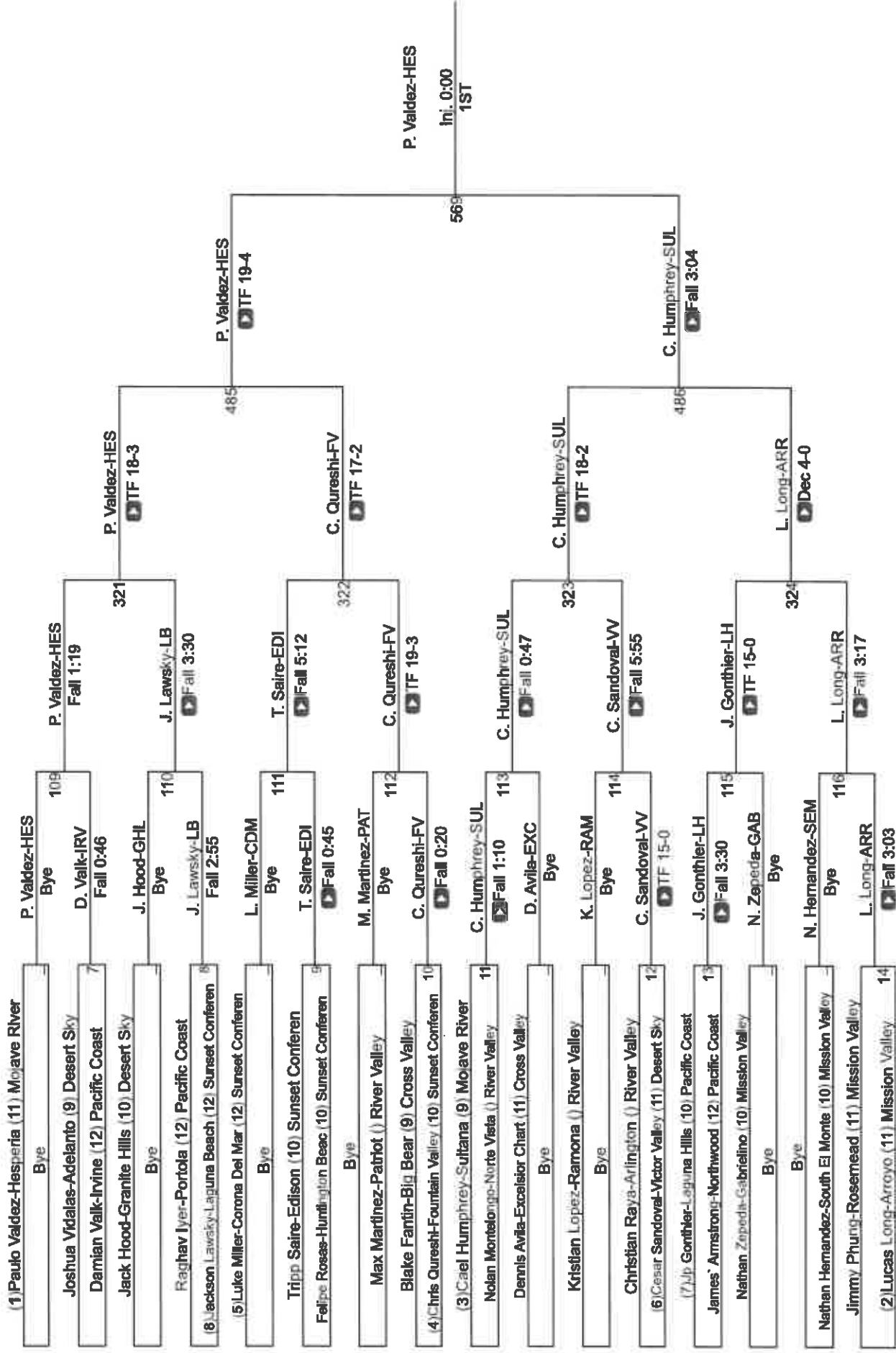

CIF Qualifier 113

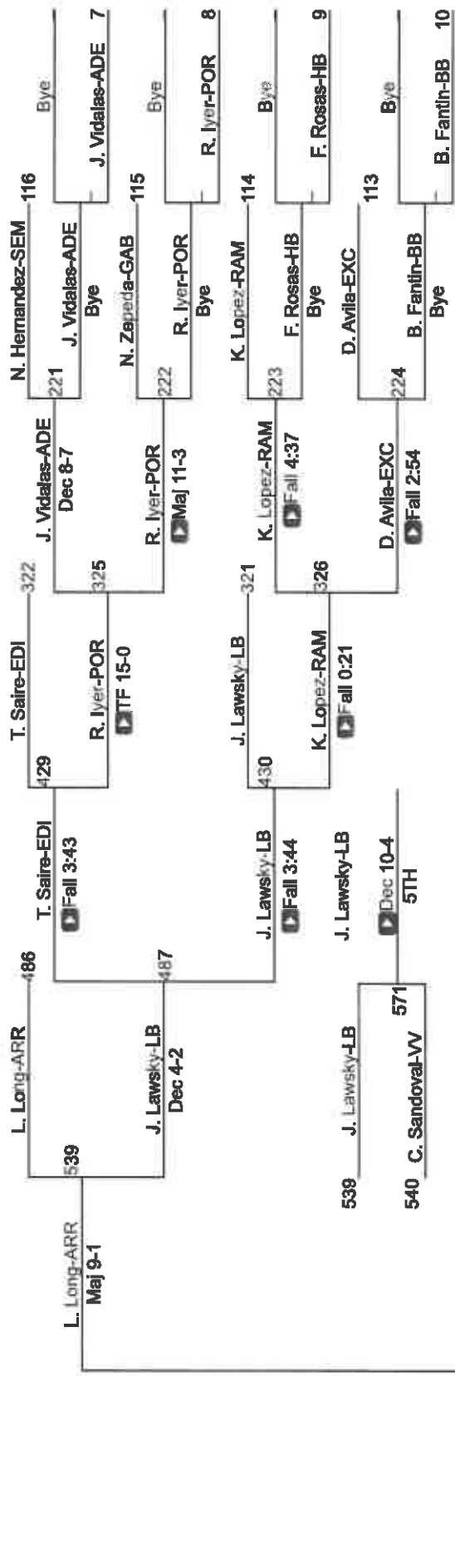

L. Long-ARR

▶ Dec 6-3 3RD

T. Saire-EDI

▶ SV-1 2-0 7TH

J. Gonthier-LH

▶ Dec 4-1

J. Gonthier-LH

▶ Dec 6-1

J. Gonthier-LH

▶ D. Valk-IRV 328

J. Gonthier-LH

▶ C. Sandoval-VV 485

▶ Maj 10-0

N. Montelongo-NRTV

▶ Bye

M. Martinez-PAT

▶ Fall 0:58

L. Miller-CDM

▶ Fall 2:07

J. Armstrong-NTWD

▶ Bye

J. Armstrong-NTWD

▶ TF 18-3

J. Phung-ROS

N. Montelongo-NRTV 11

N. Montelongo-NRTV 225

M. Martinez-PAT 112

M. Martinez-PAT 111

C. Raya-ARL 12

C. Raya-ARL 226

L. Miller-CDM 111

L. Miller-CDM 226

J. Armstrong-NTWD 13

J. Armstrong-NTWD 227

J. Phung-ROS 14

N. Montelongo-NRTV 11

N. Montelongo-NRTV 225

M. Martinez-PAT 112

M. Martinez-PAT 111

C. Raya-ARL 12

C. Raya-ARL 226

L. Miller-CDM 111

L. Miller-CDM 226

J. Armstrong-NTWD 13

J. Armstrong-NTWD 227

J. Phung-ROS 14

N. Montelongo-NRTV 11

N. Montelongo-NRTV 225

M. Martinez-PAT 112

M. Martinez-PAT 111

C. Raya-ARL 12

C. Raya-ARL 226

L. Miller-CDM 111

L. Miller-CDM 226

J. Armstrong-NTWD 13

J. Armstrong-NTWD 227

J. Phung-ROS 14

N. Montelongo-NRTV 11

N. Montelongo-NRTV 225

M. Martinez-PAT 112

M. Martinez-PAT 111

C. Raya-ARL 12

C. Raya-ARL 226

L. Miller-CDM 111

L. Miller-CDM 226

J. Armstrong-NTWD 13

J. Armstrong-NTWD 227

J. Phung-ROS 14

N. Montelongo-NRTV 11

N. Montelongo-NRTV 225

M. Martinez-PAT 112

M. Martinez-PAT 111

C. Raya-ARL 12

C. Raya-ARL 226

L. Miller-CDM 111

L. Miller-CDM 226

J. Armstrong-NTWD 13

J. Armstrong-NTWD 227

J. Phung-ROS 14

N. Montelongo-NRTV 11

N. Montelongo-NRTV 225

M. Martinez-PAT 112

M. Martinez-PAT 111

C. Raya-ARL 12

C. Raya-ARL 226

L. Miller-CDM 111

L. Miller-CDM 226

J. Armstrong-NTWD 13

J. Armstrong-NTWD 227

J. Phung-ROS 14

N. Montelongo-NRTV 11

N. Montelongo-NRTV 225

M. Martinez-PAT 112

M. Martinez-PAT 111

C. Raya-ARL 12

C. Raya-ARL 226

L. Miller-CDM 111

L. Miller-CDM 226

J. Armstrong-NTWD 13

J. Armstrong-NTWD 227

J. Phung-ROS 14

EIF SS Boys Individuals Inland Div

EIF Qualifier 120

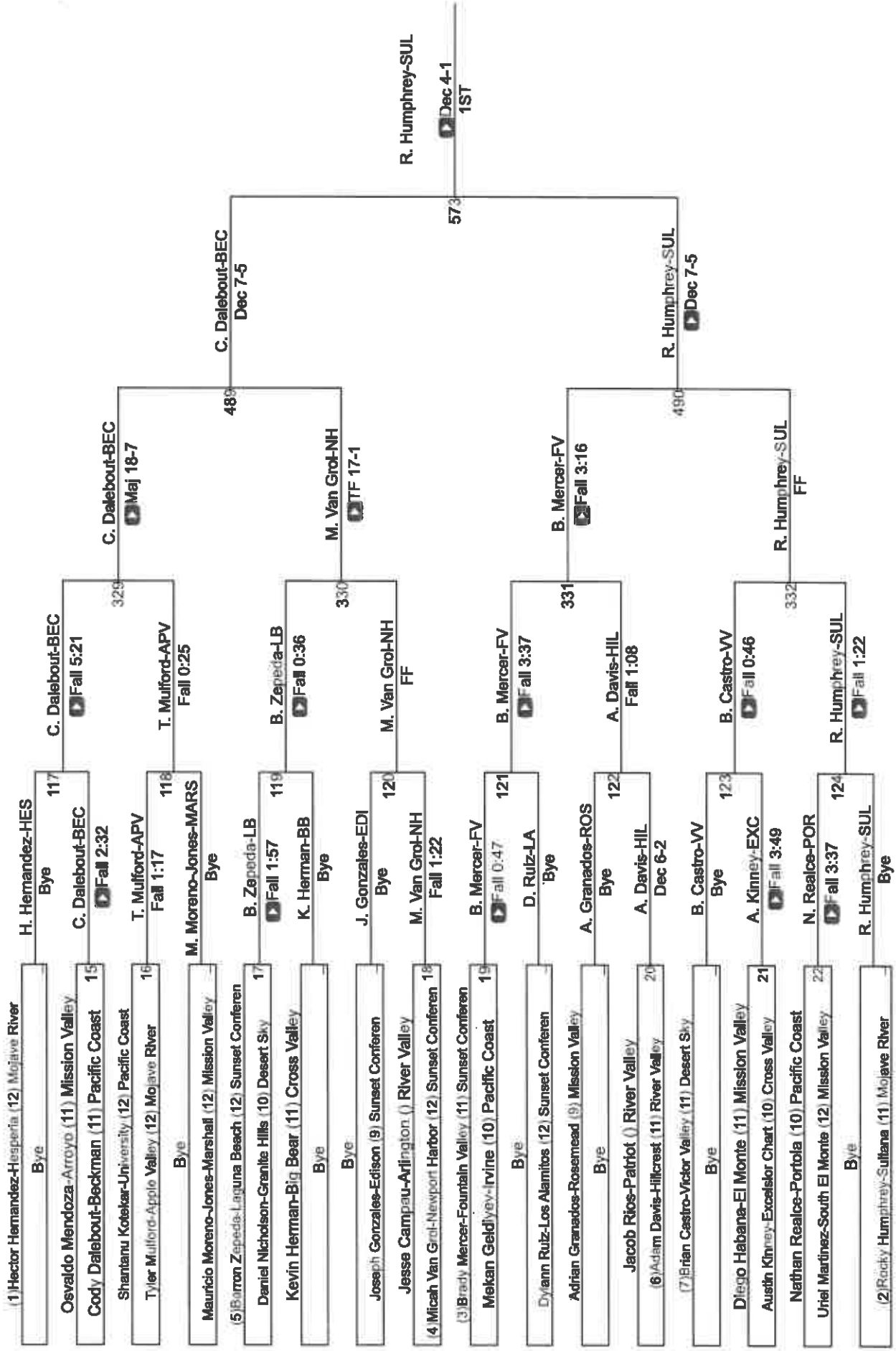

CIF Qualifier 120

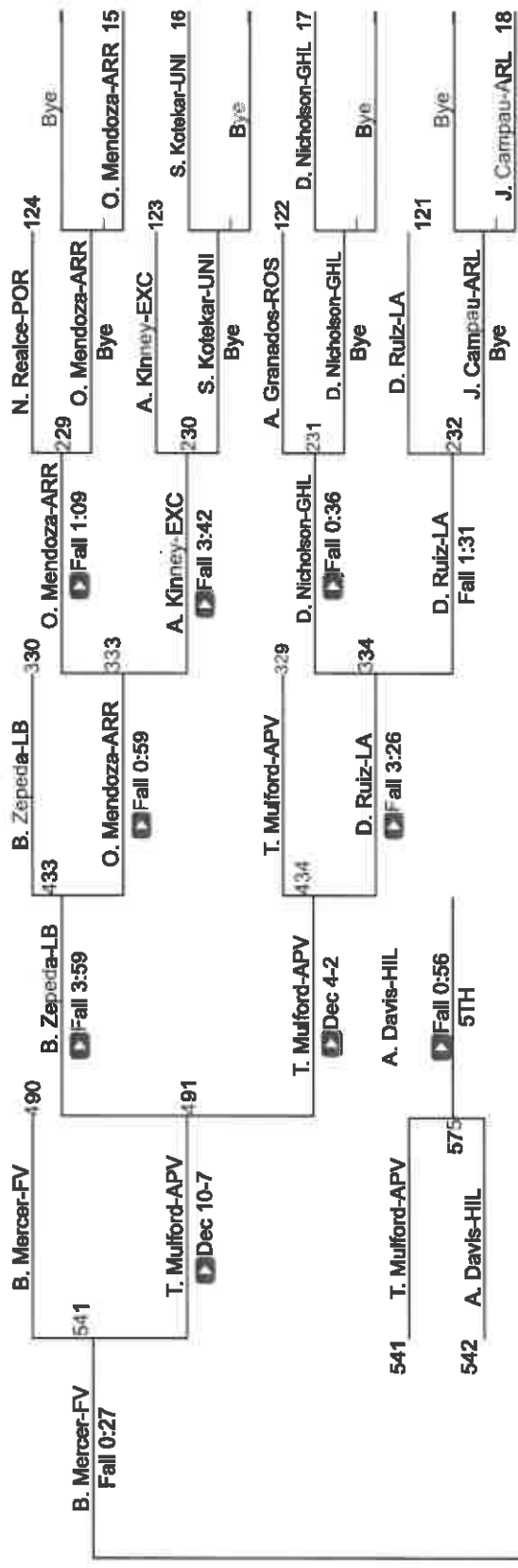

B. Mercer-FV

Dec 6-3
3RD

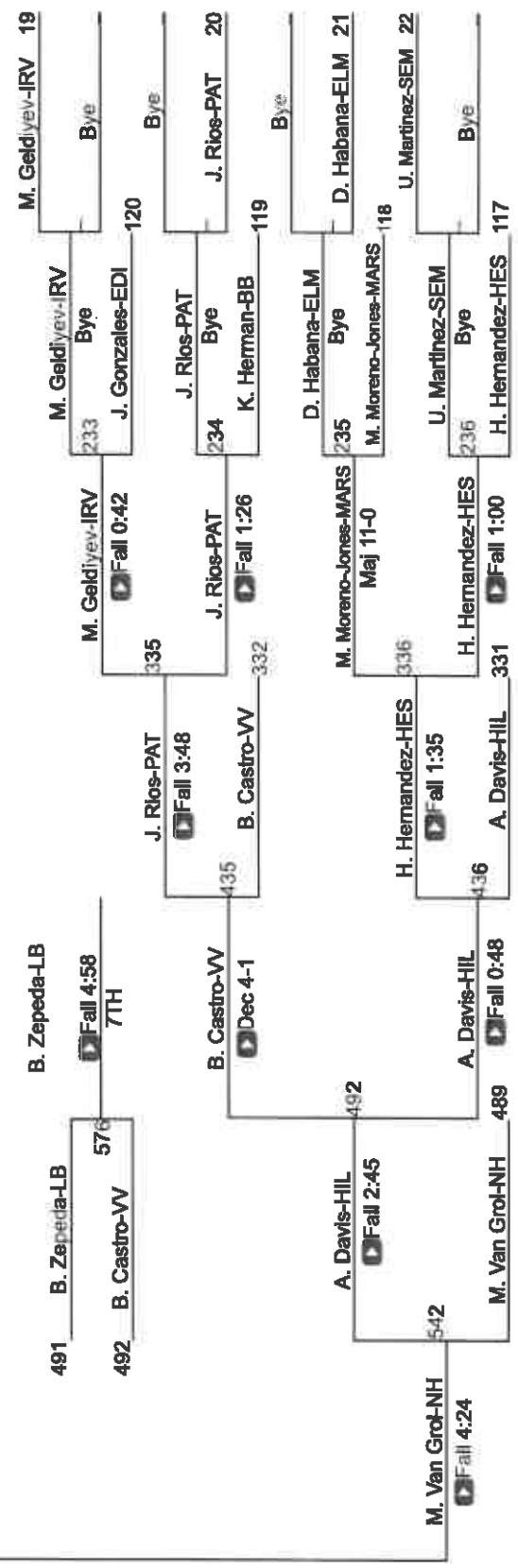

CIF SS Boys Individuals Inland Div

CIF Qualifier 126

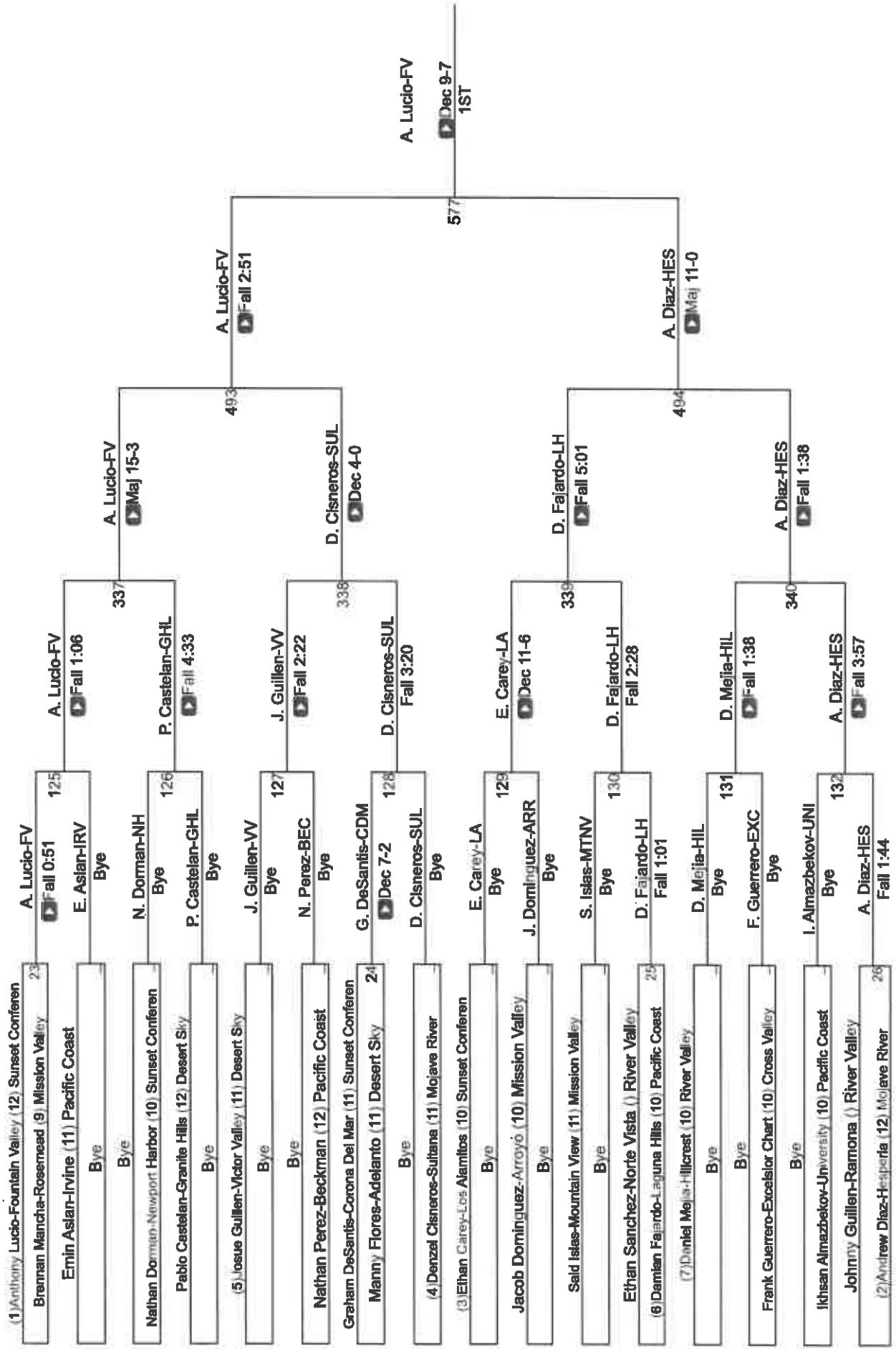

CIF Qualifier 126

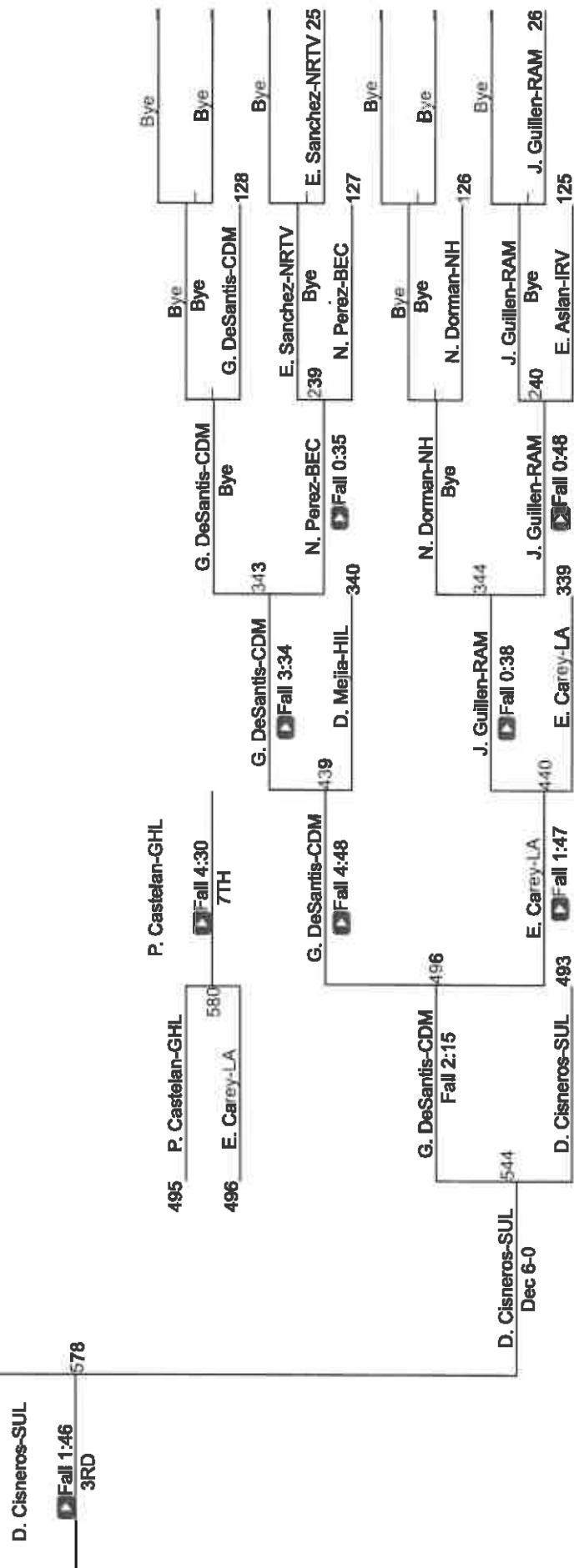
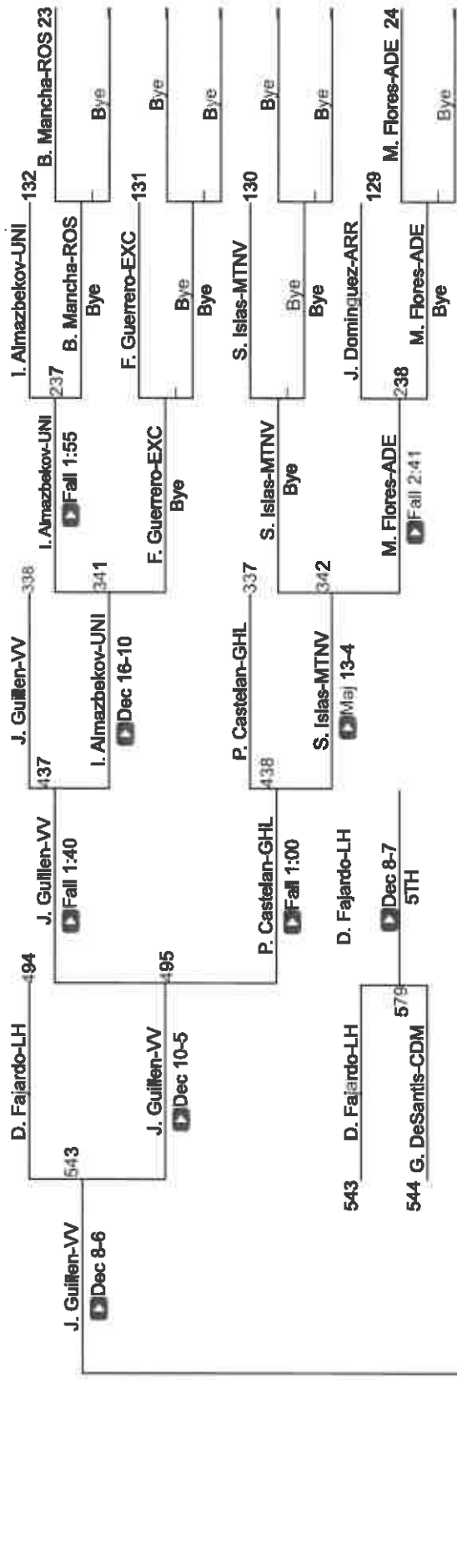

EIF SS Boys Individuals Inland Div

EIF Qualifier 132

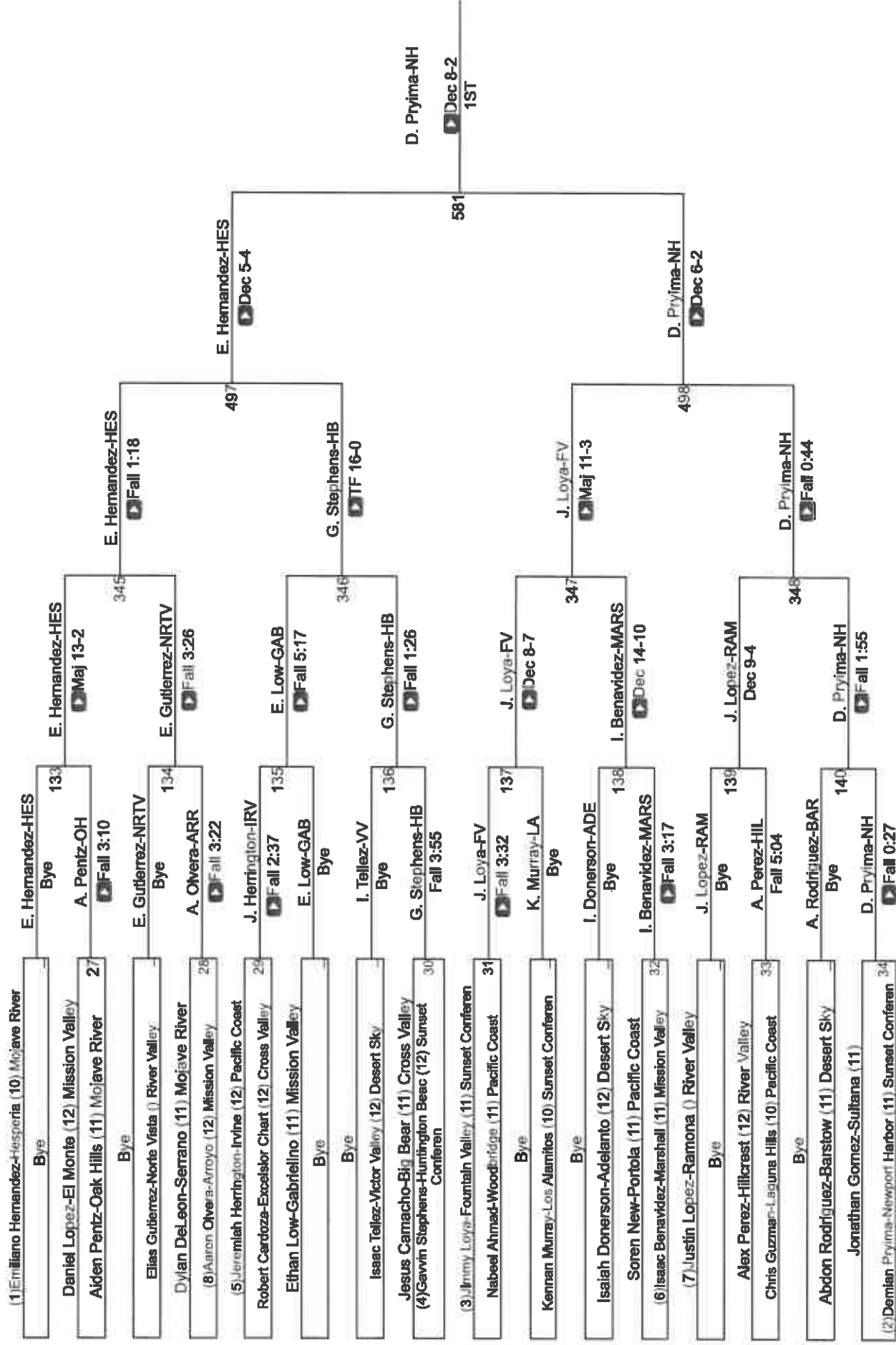

EIF SS Boys Individuals Inland Div

EIF Qualifier 138

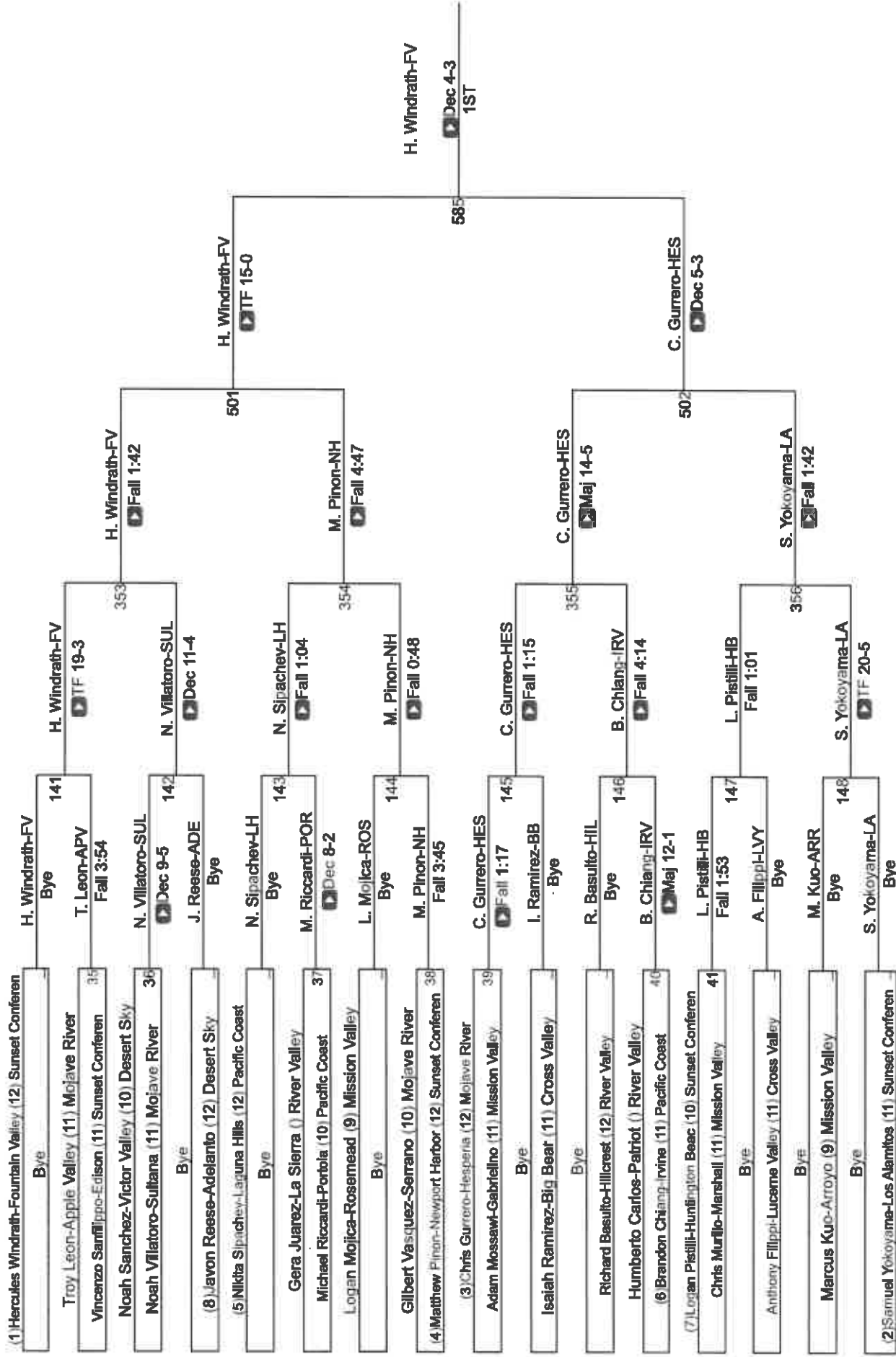

CIF Qualifier 138

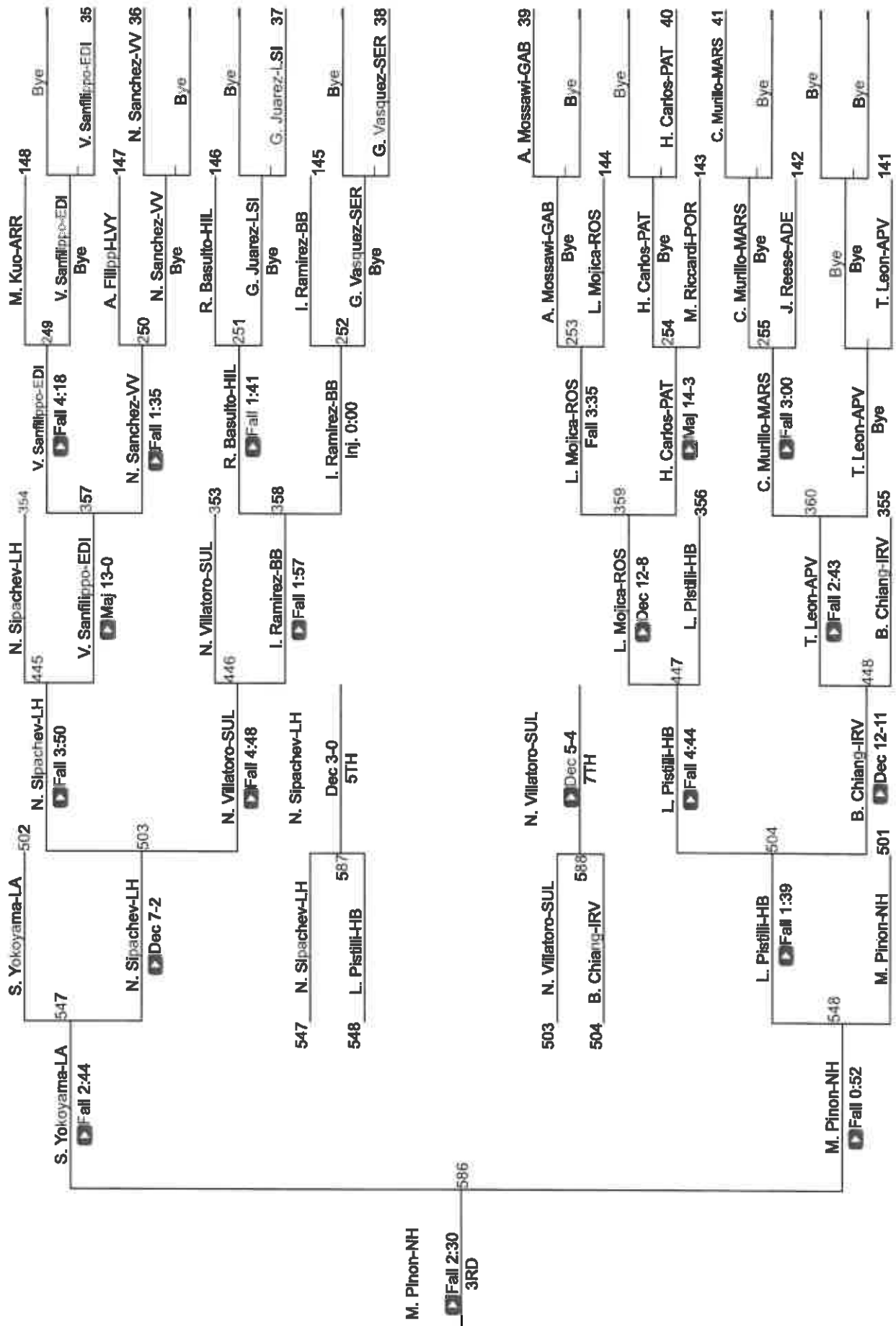

CIF SS Boys Individuals Inland Div

CIF Qualifier 144

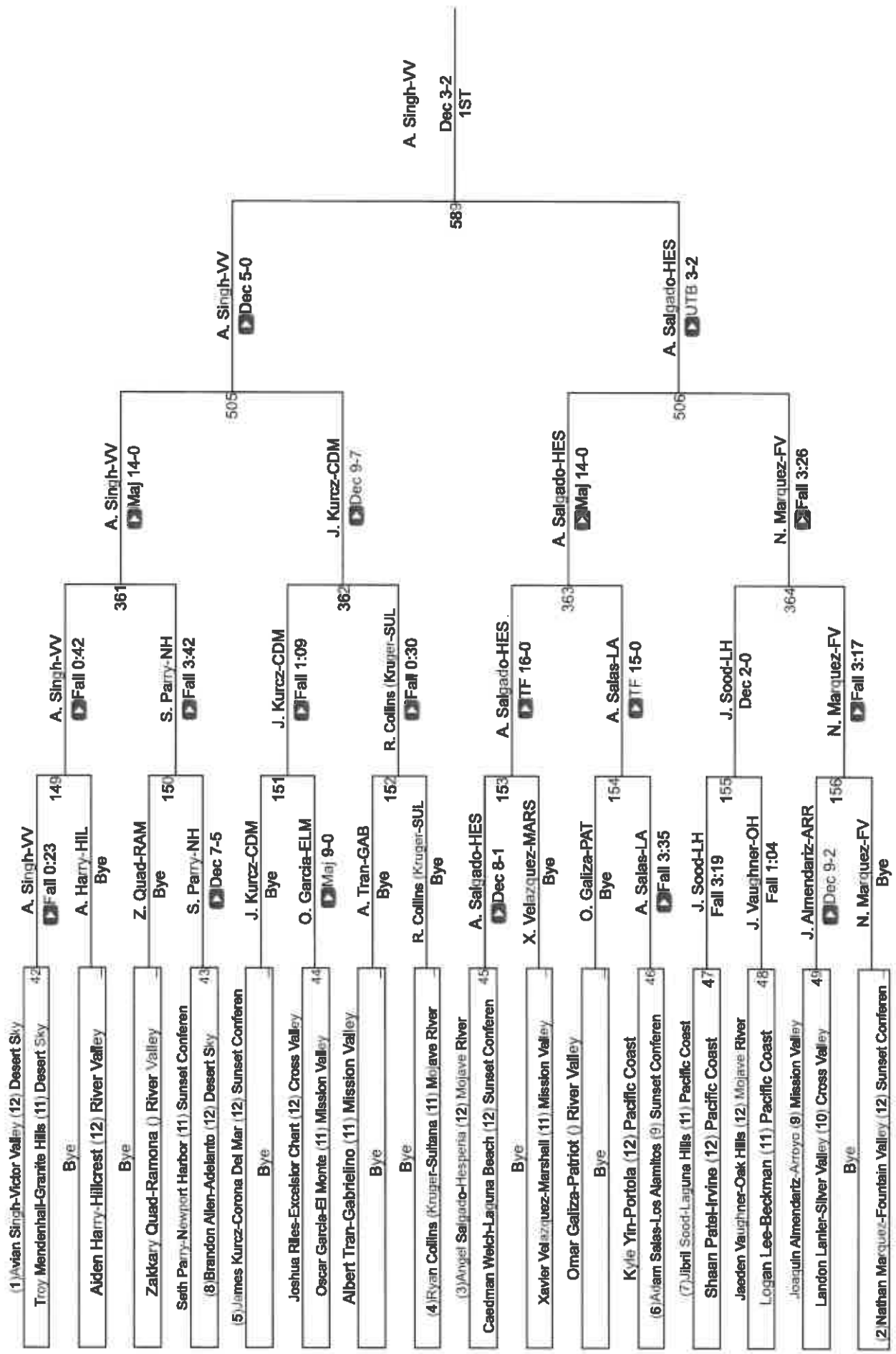

CIF Qualifier 144

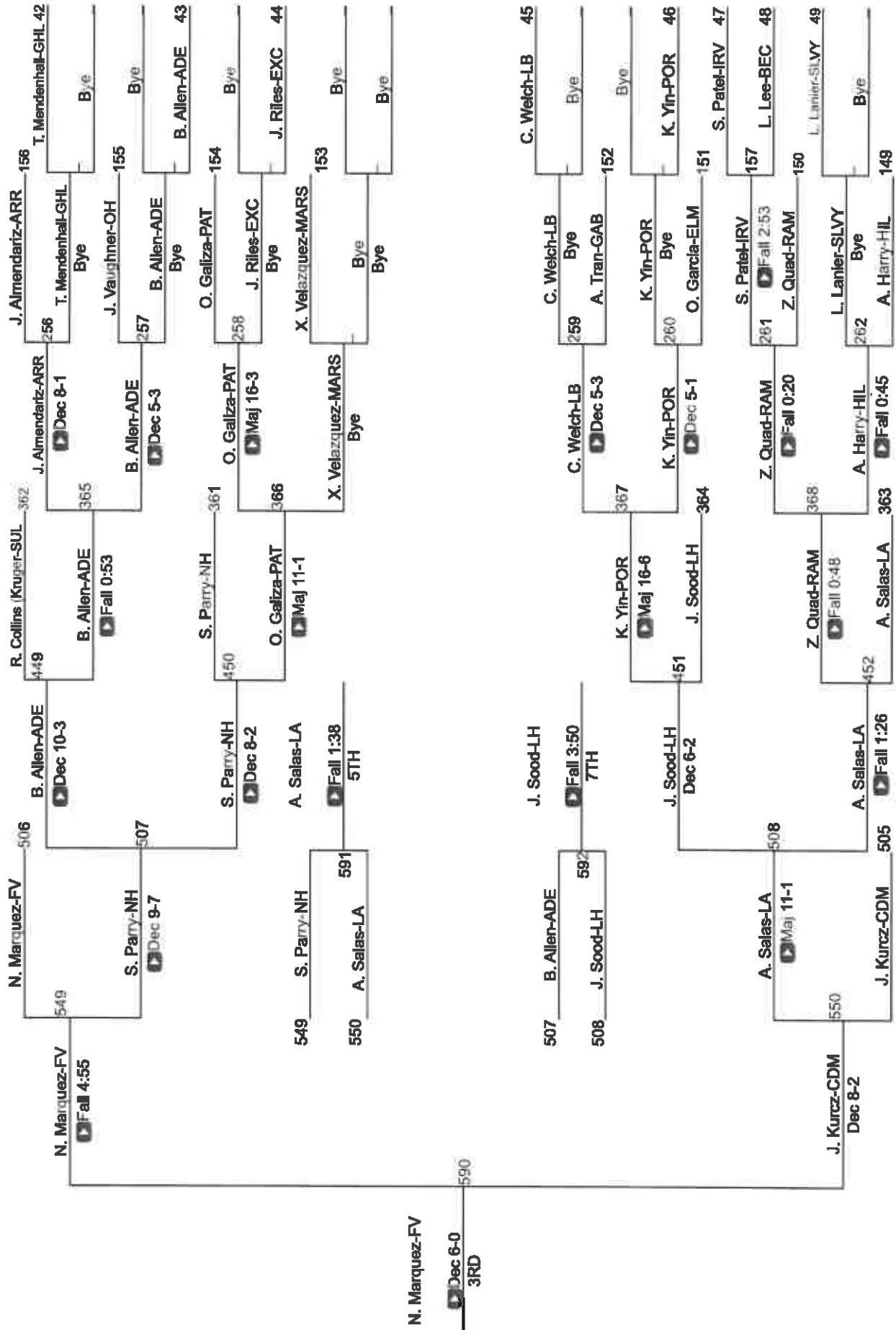

EIF SS Boys Individuals Inland Div

EIF Qualifier 150

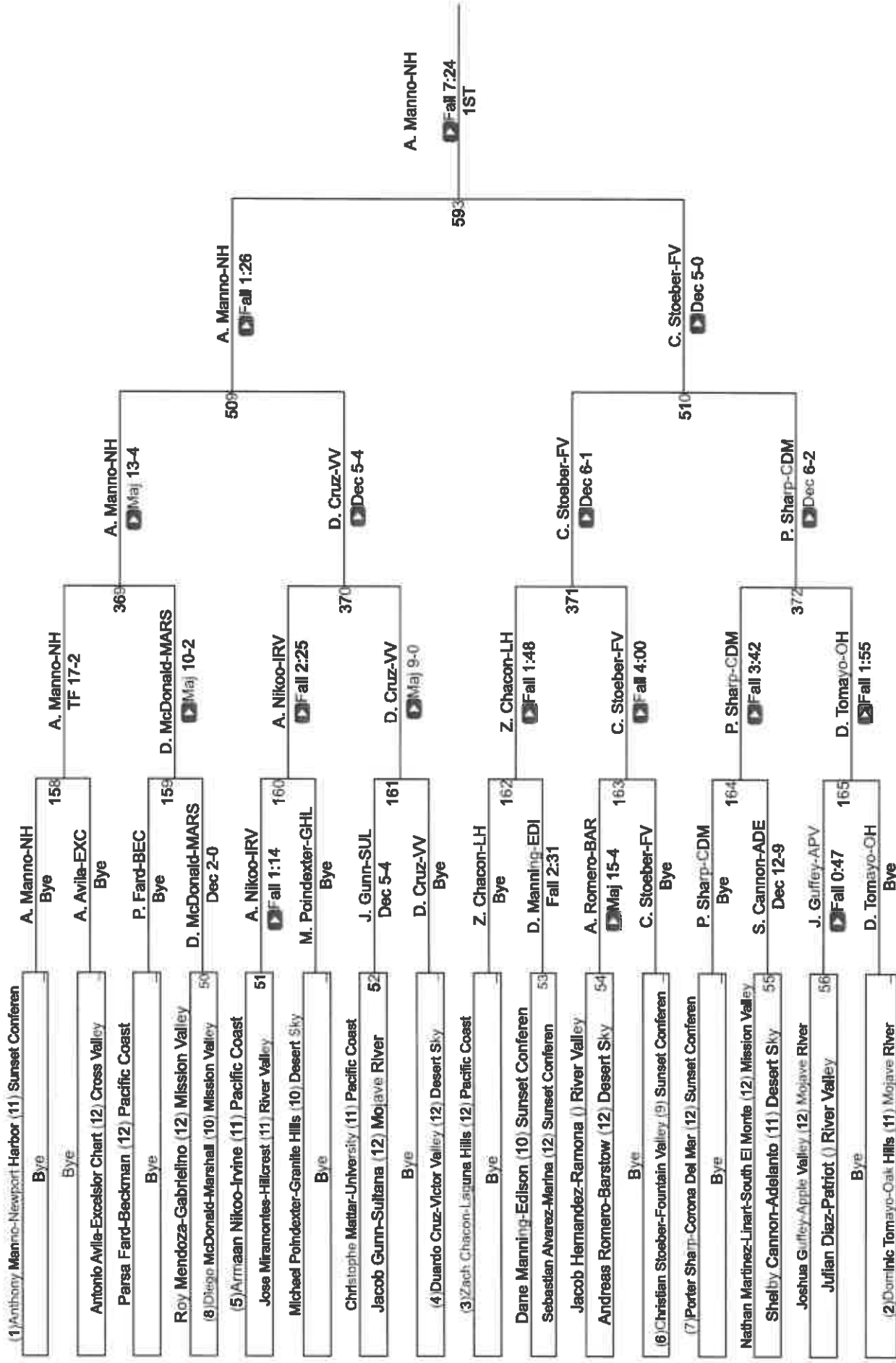

CIF Qualifier 150

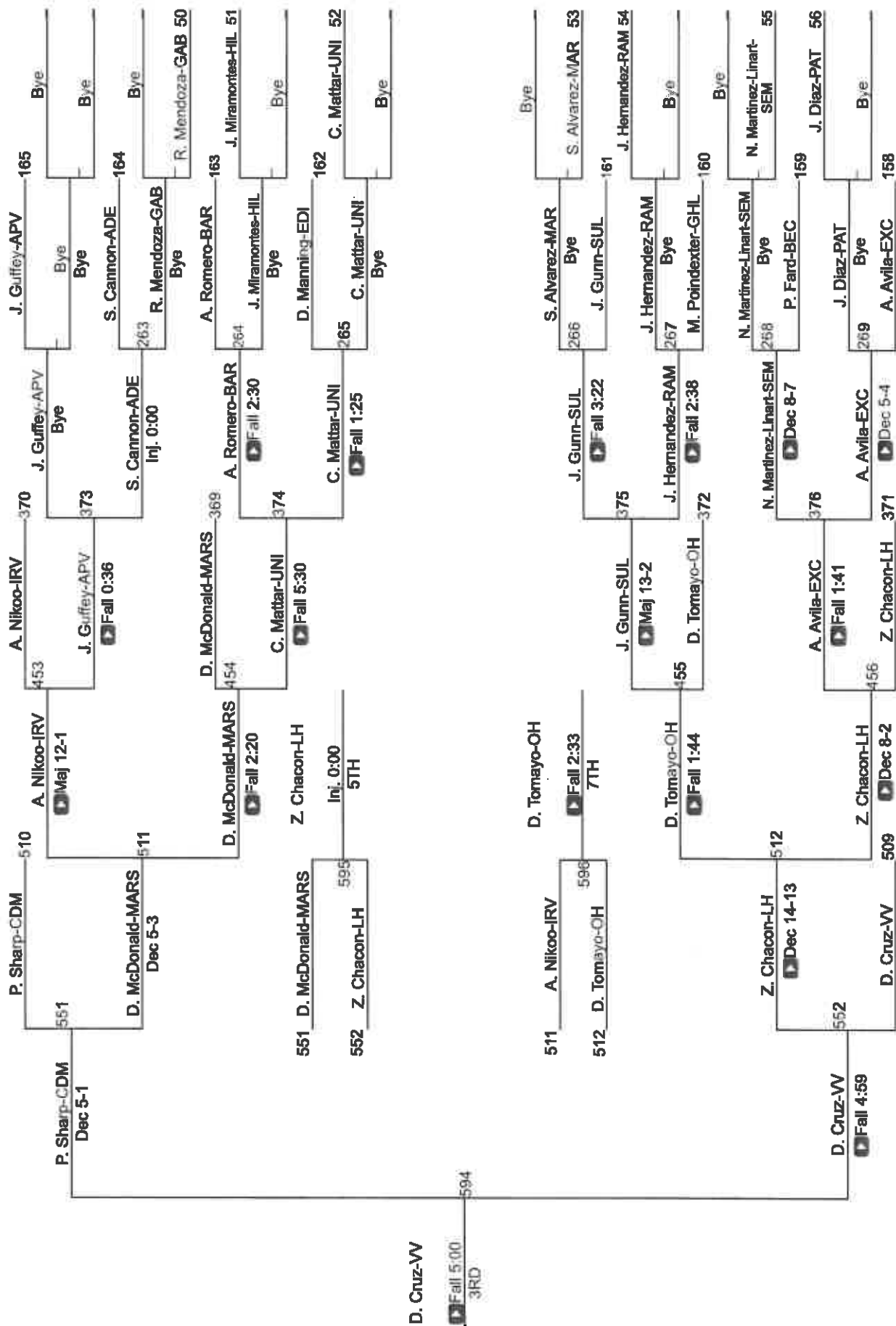

GIF SS Boys Individuals Inland Div

GIF Qualifier 157

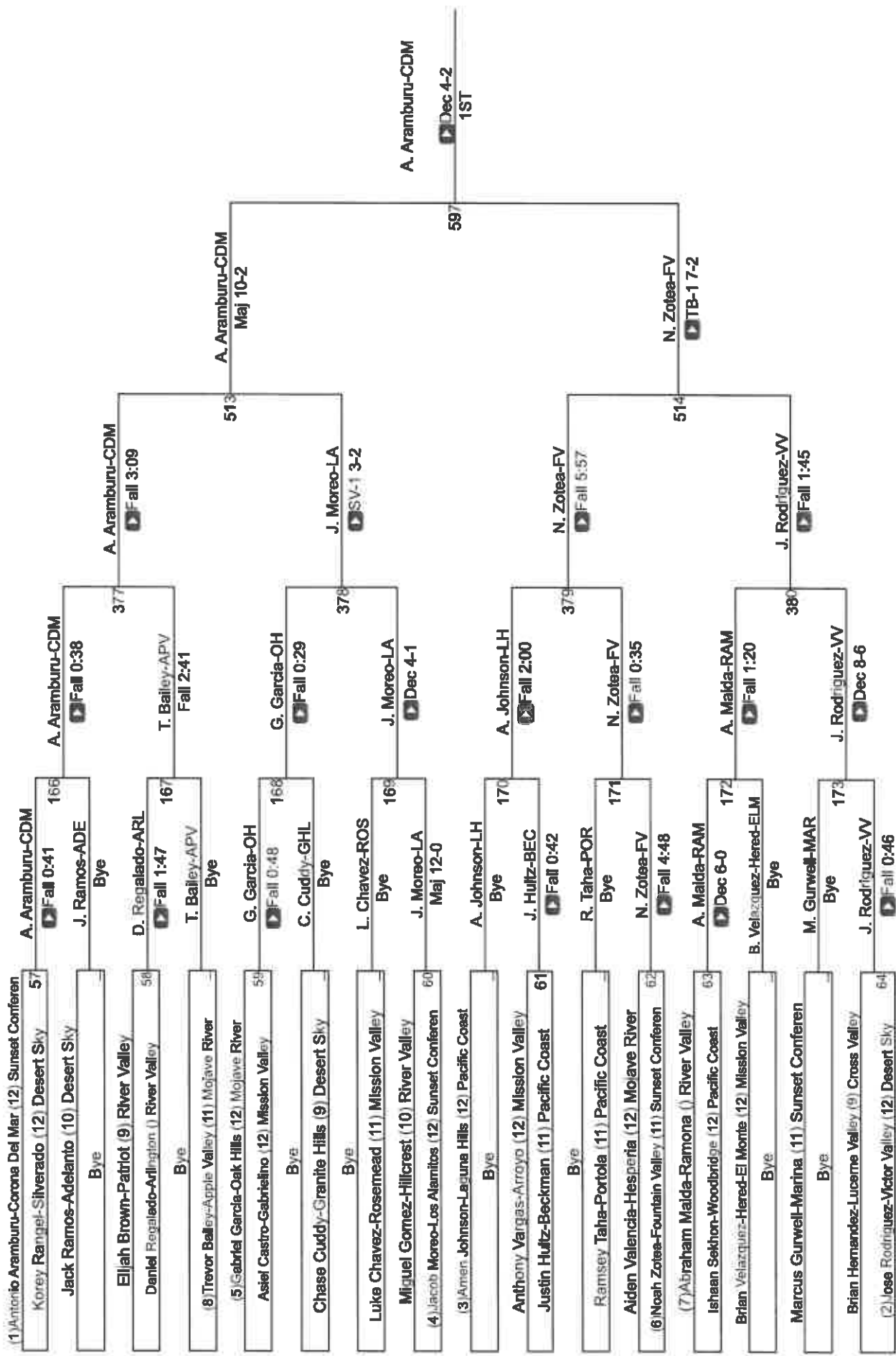

EIF Qualifier 157

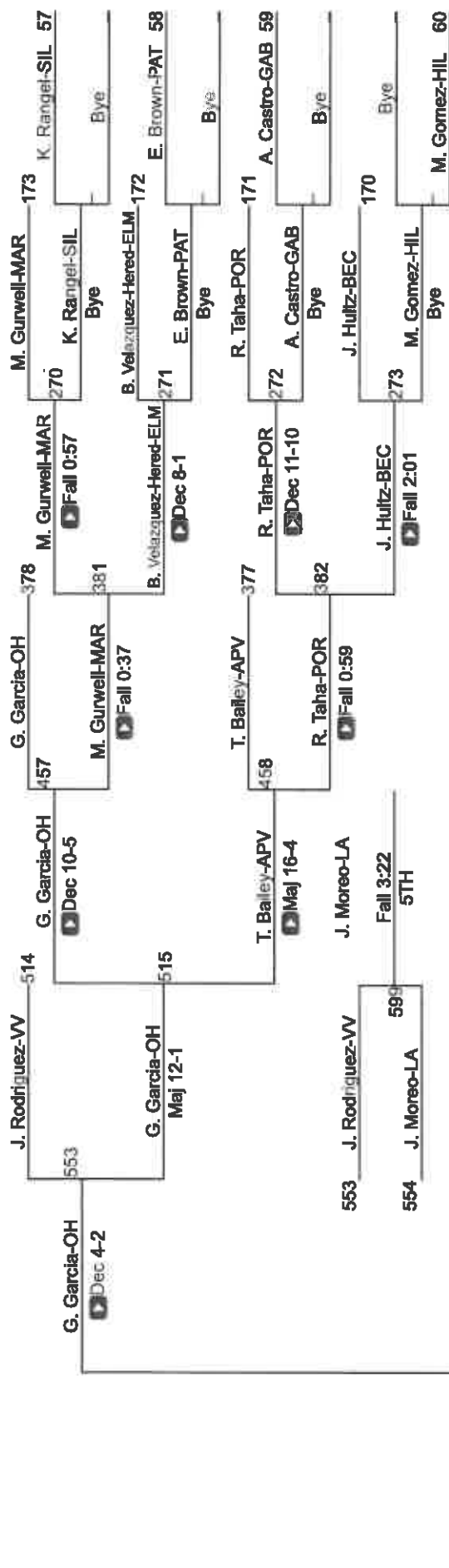

A. Johnson-LH

Inj. 0:00
3RD

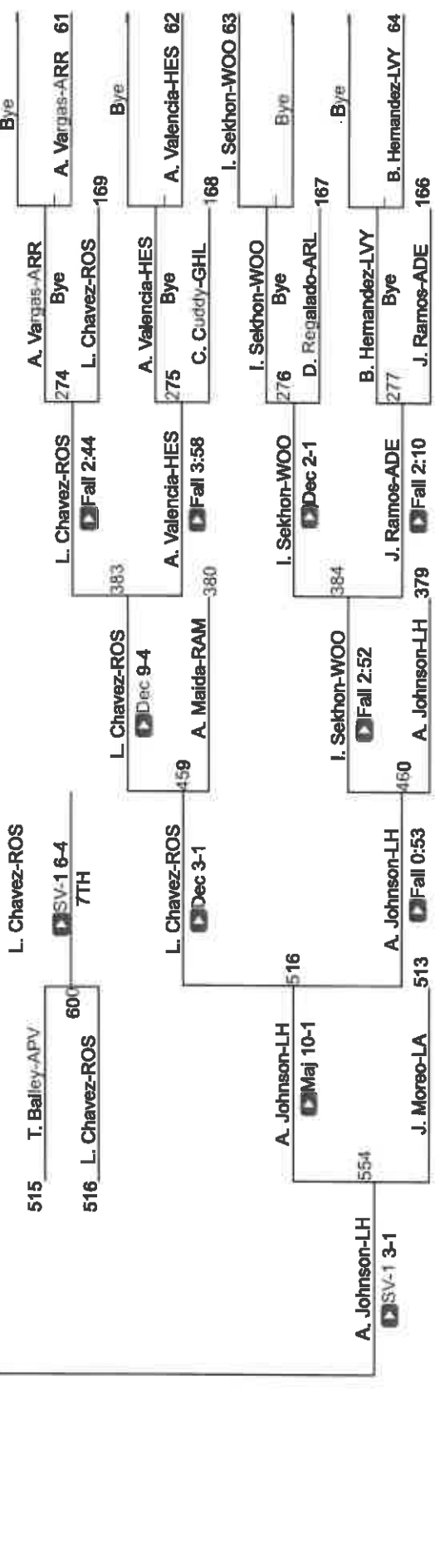

CIF SS Boys Individuals Inland Div

CIF Qualifier 165

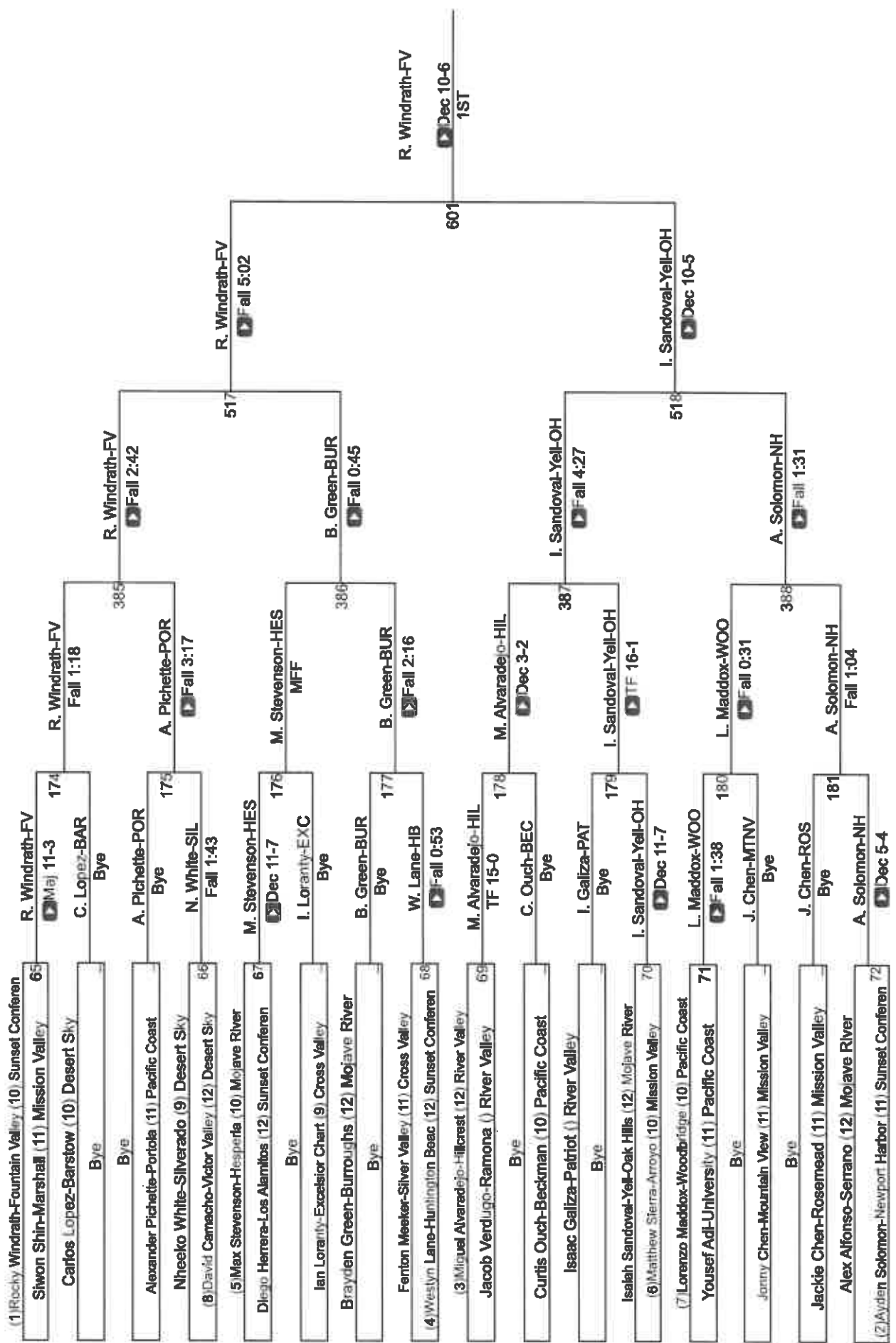

CIF Qualifier 165

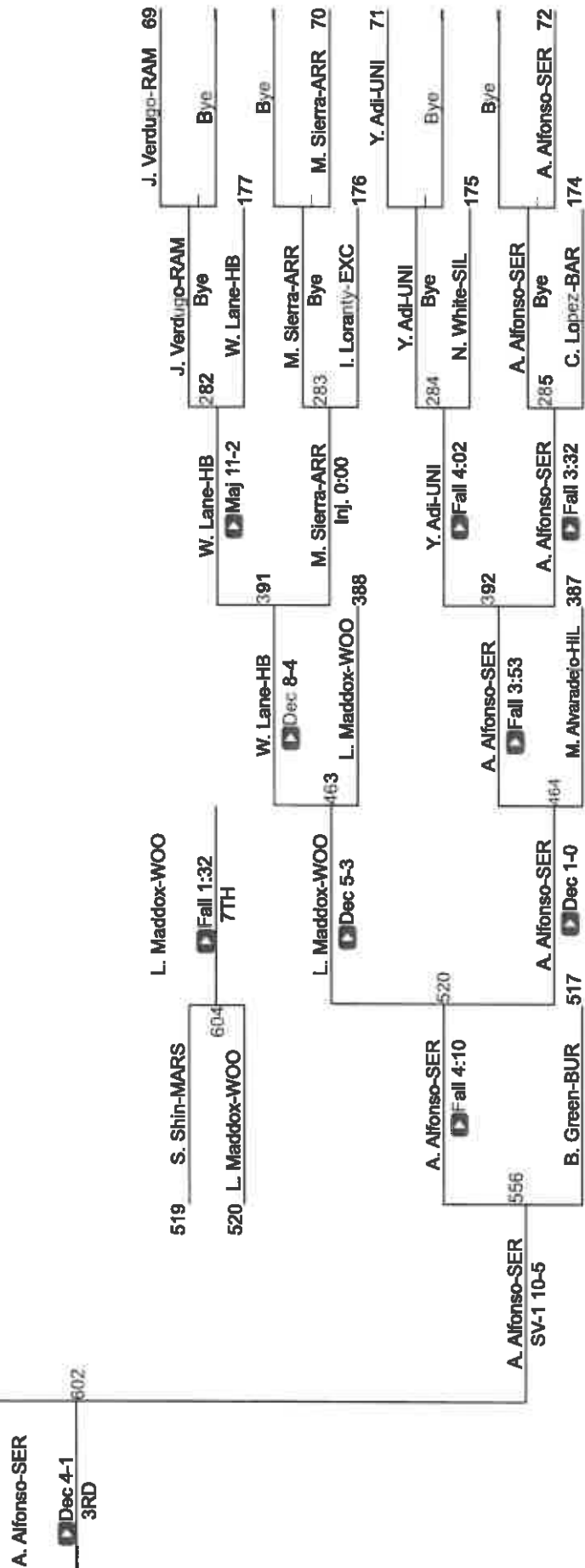
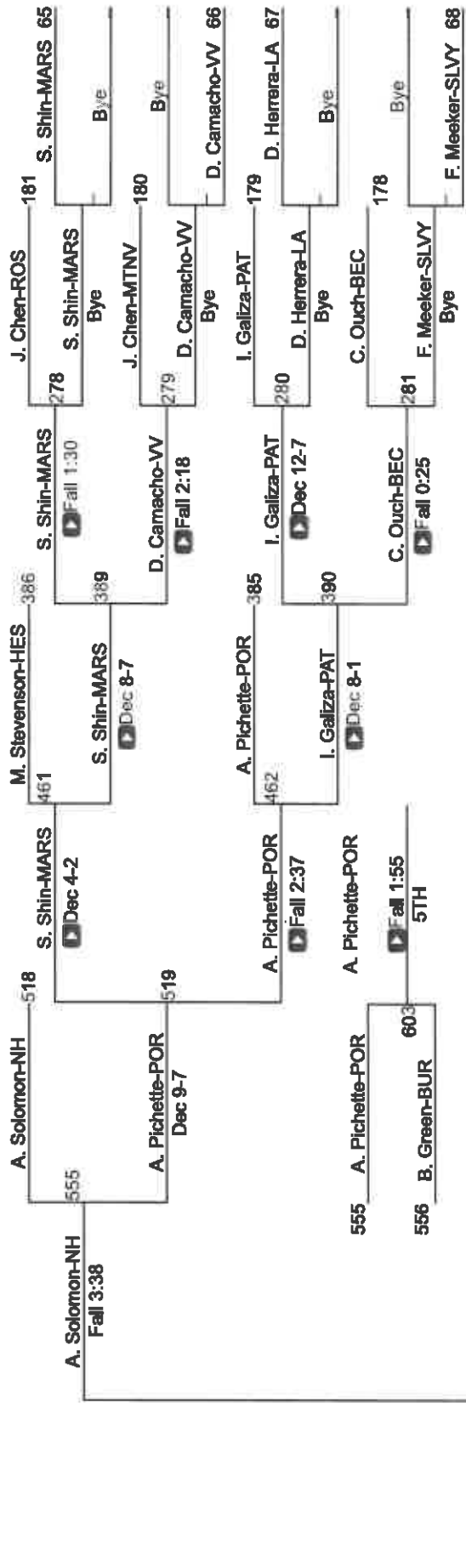

EIF SS Boys Individuals Inland Div

EIF Qualifier 175

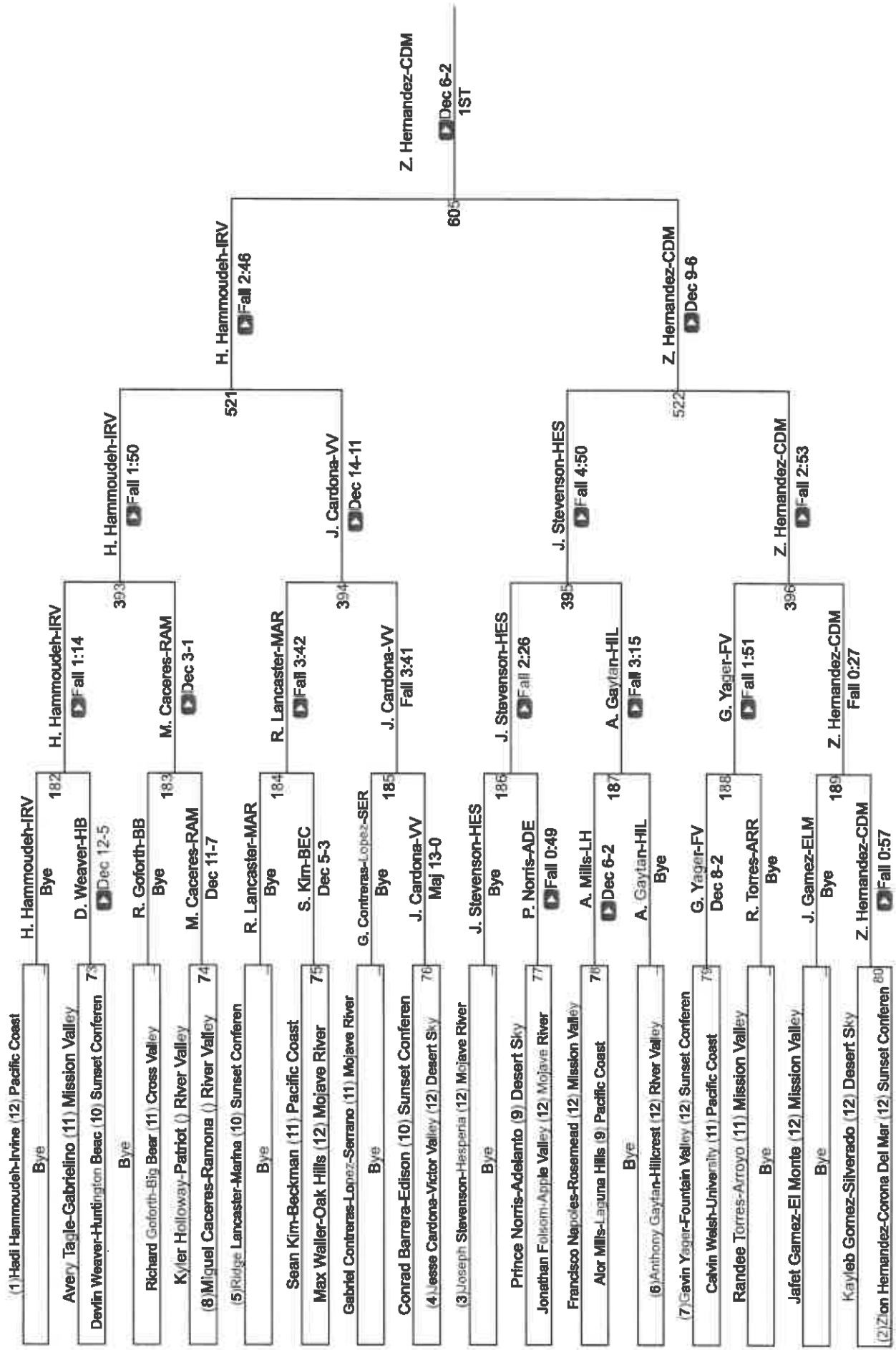

EIF Qualifier 175

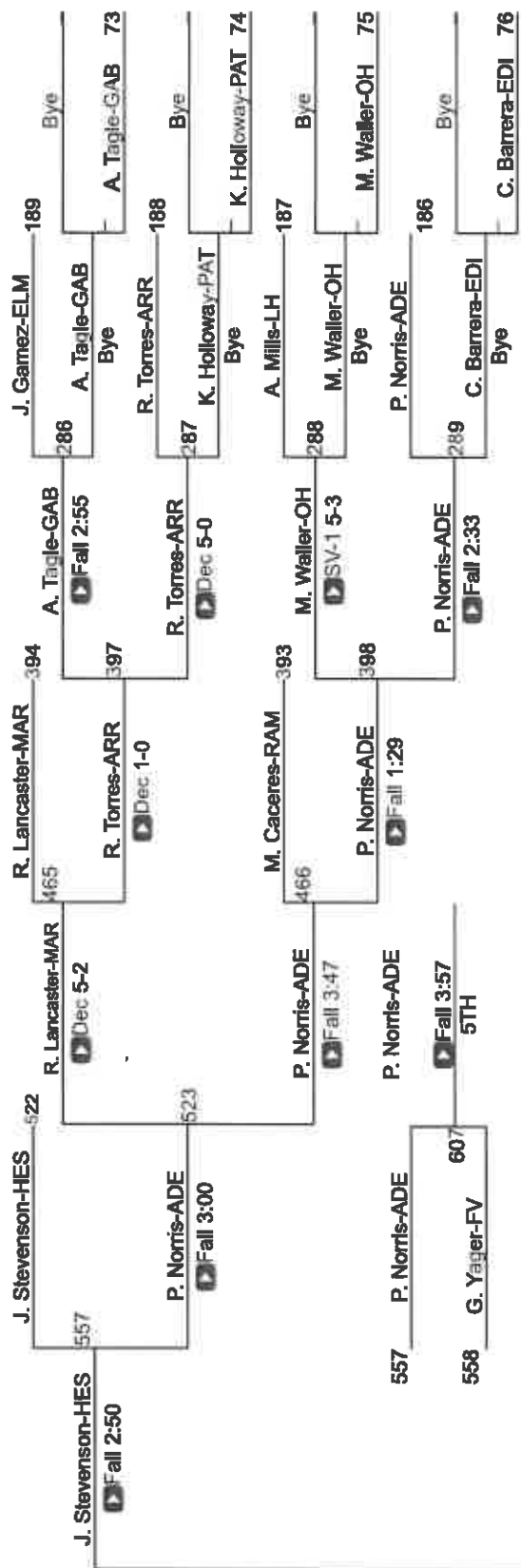

J. Stevenson-HES

Dec 7-1
3RD

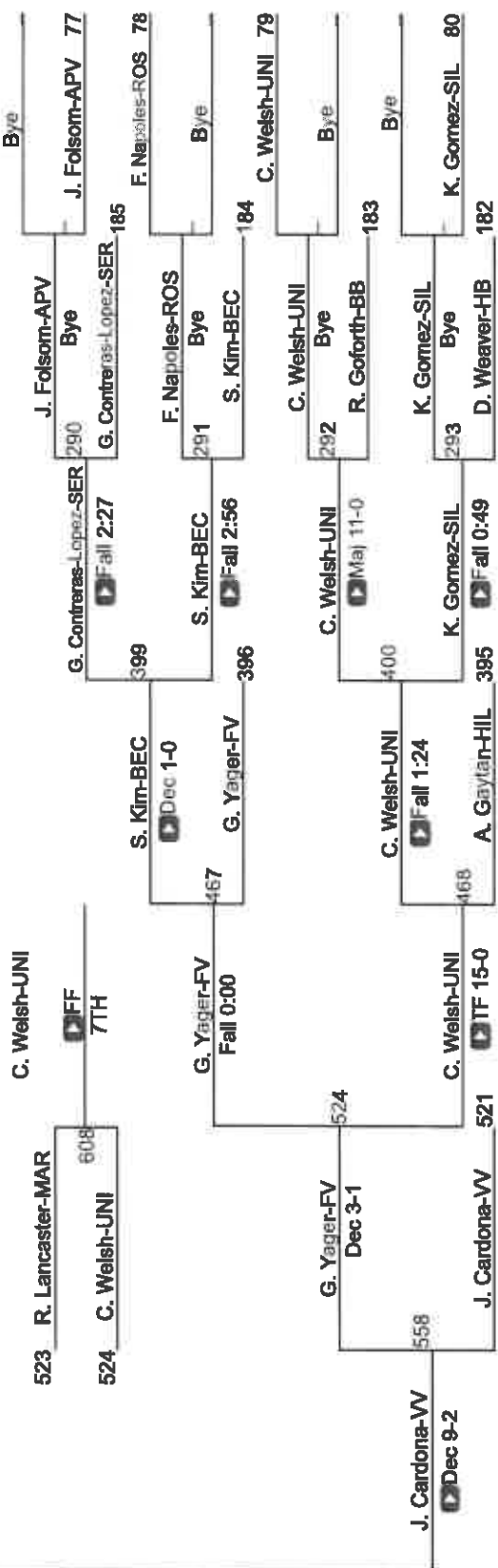

J. Stevenson-HES

Dec 7-1
3RD

CIF SS Boys Individuals Inland Div

CIF Qualifier 190

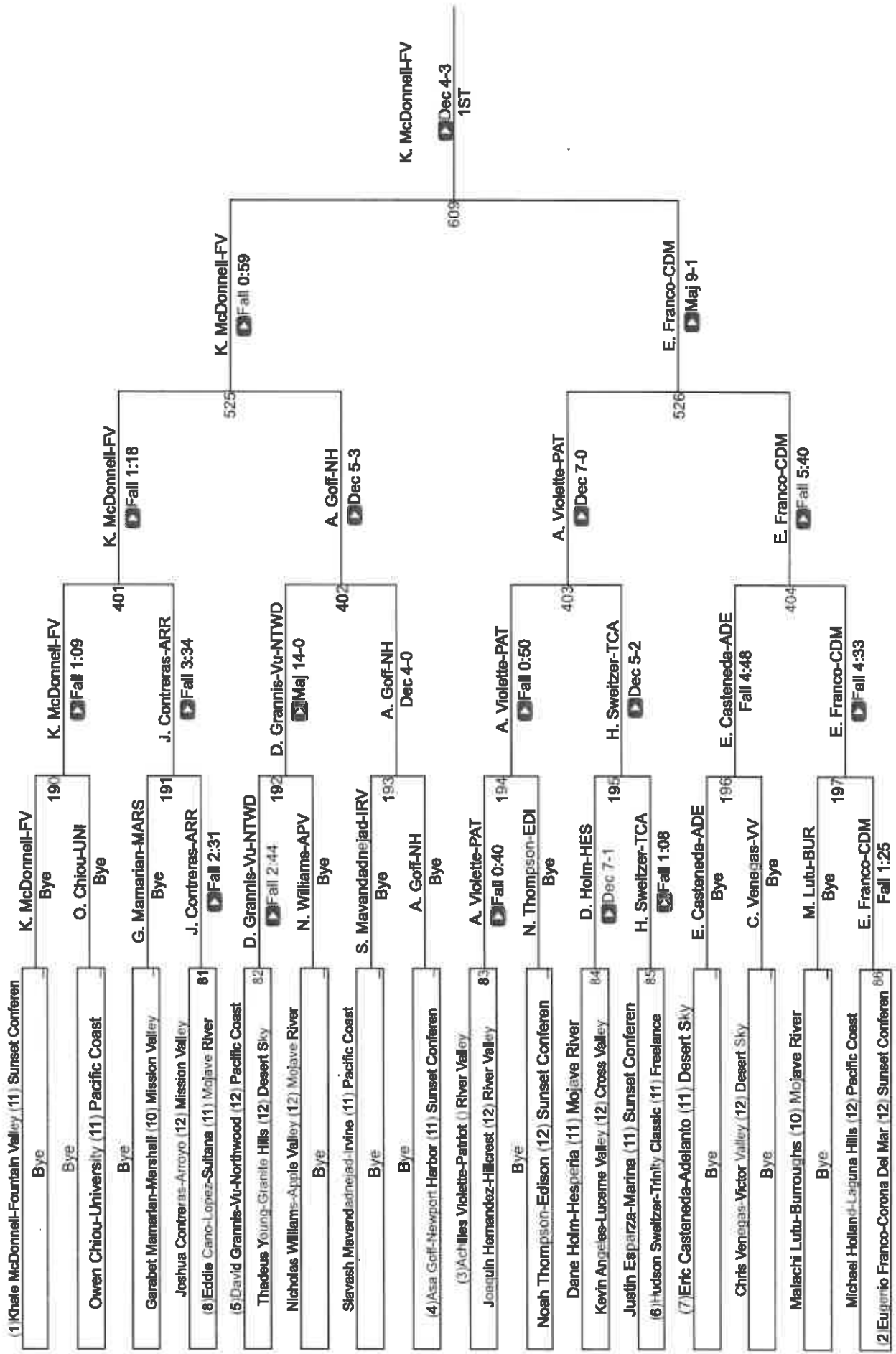

CIF Qualifier 190

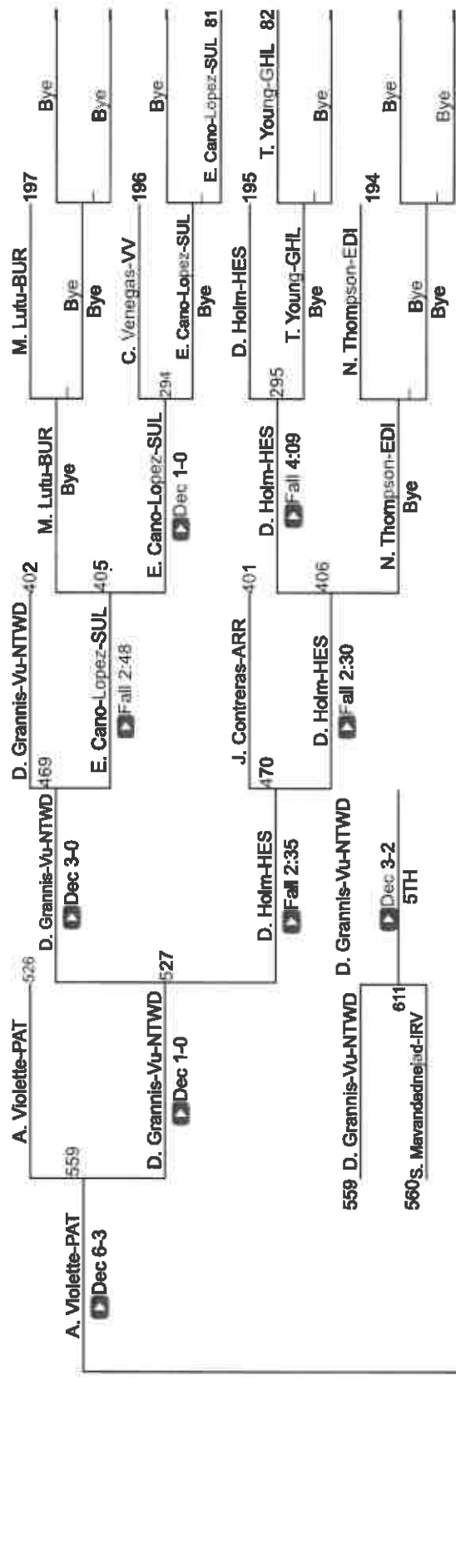

A. Violette-PAT

Dec 16-10
3RD

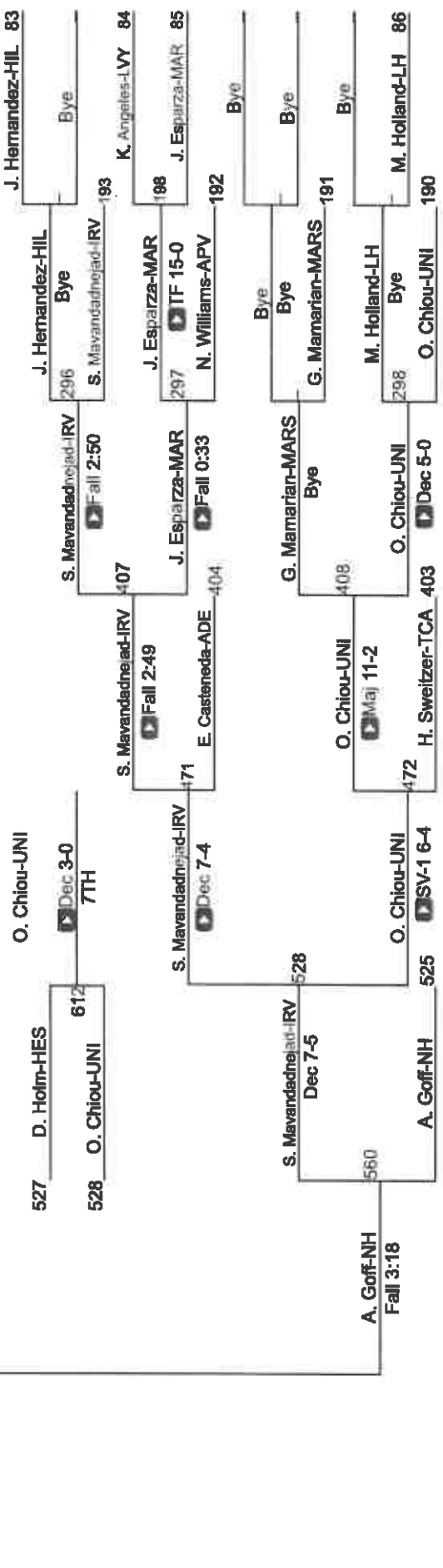

A. Goff-NH

Dec 16-10
3RD

CIF SS Boys Individuals Inland Div

CIF Qualifier 215

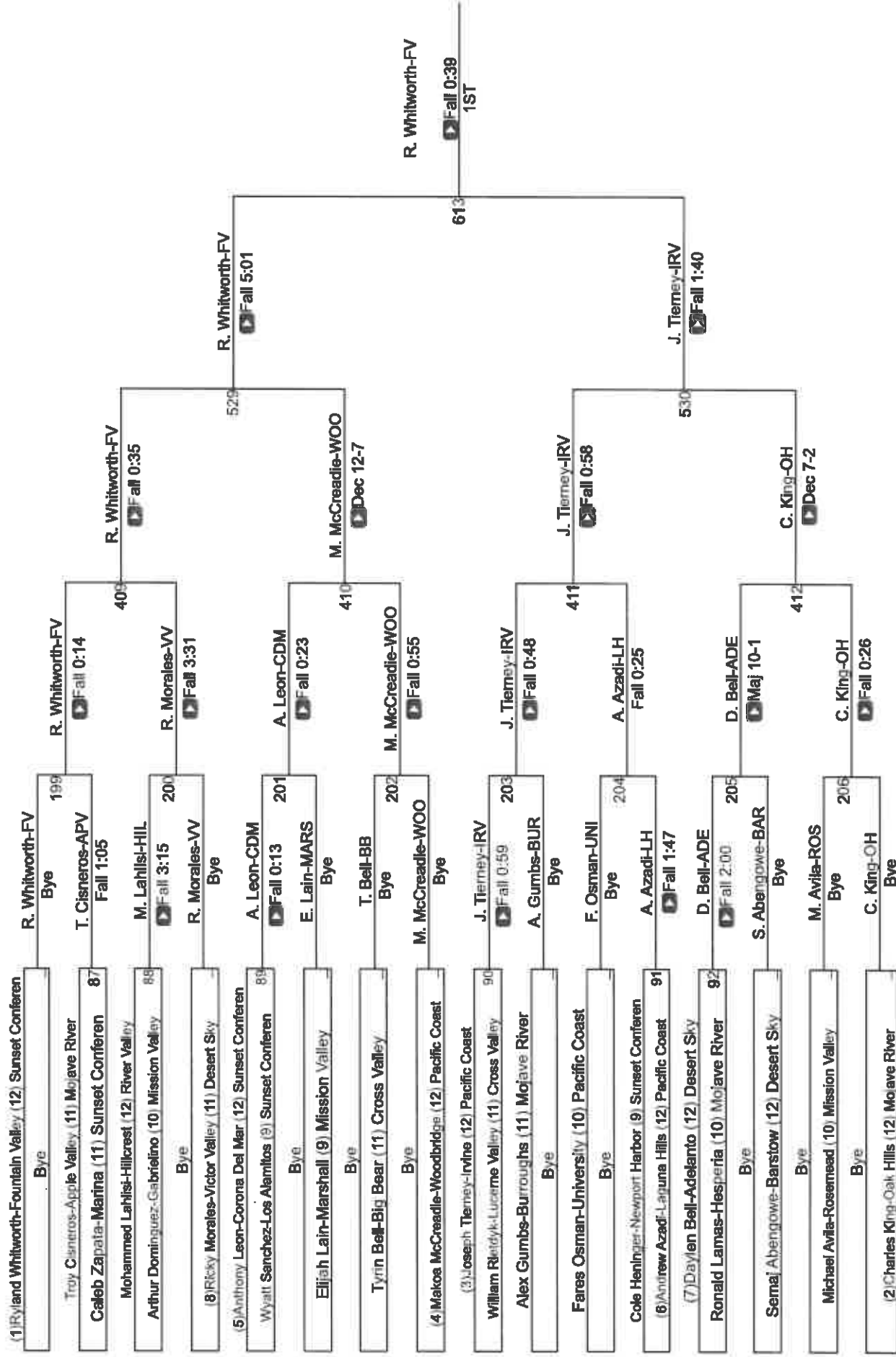

EIF Qualifier 215

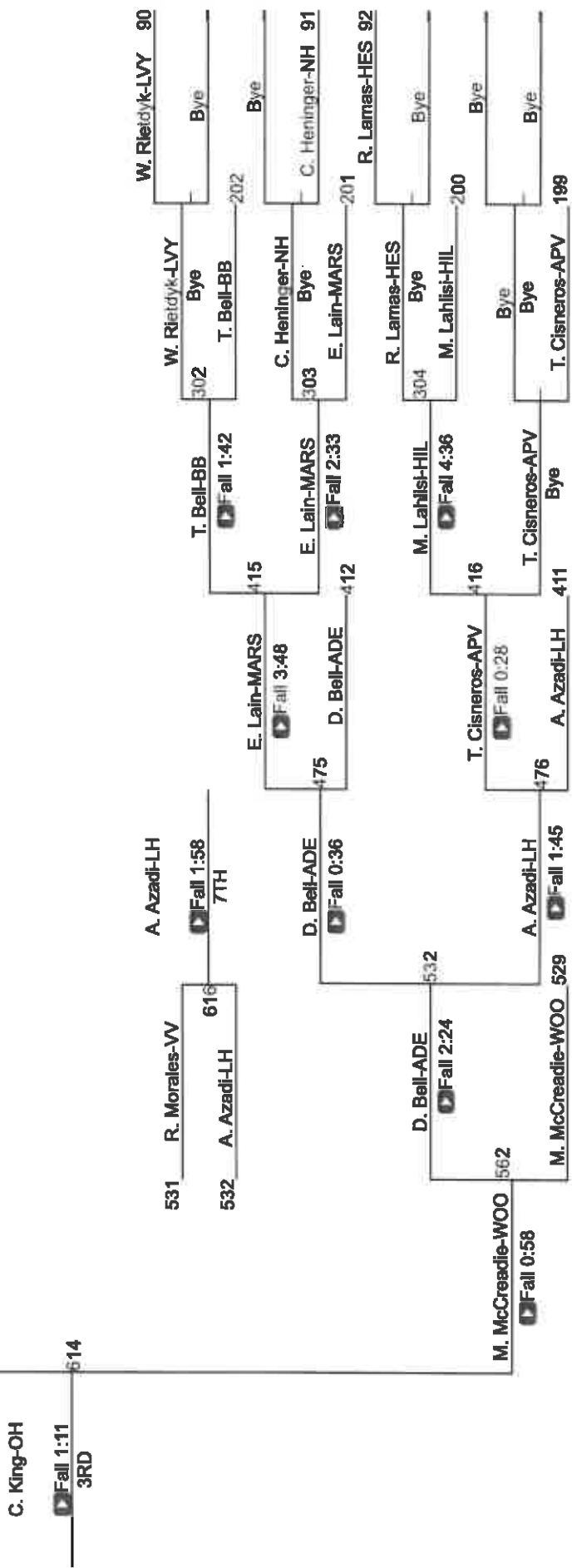
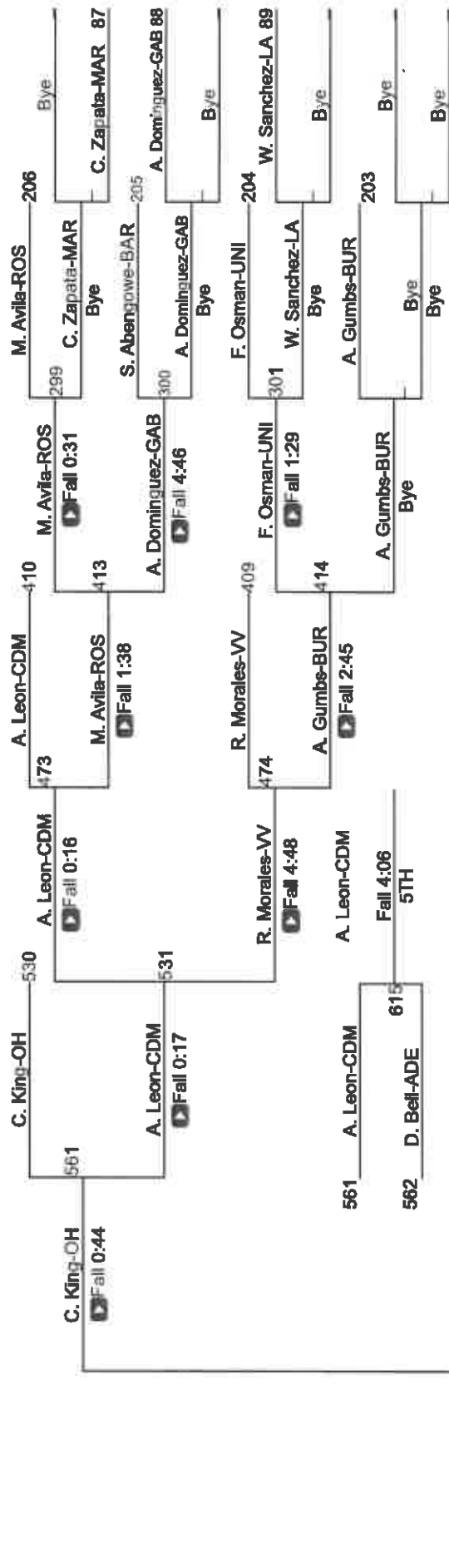

EIF SS Boys Individuals Inland Div

EIF Qualifier 285

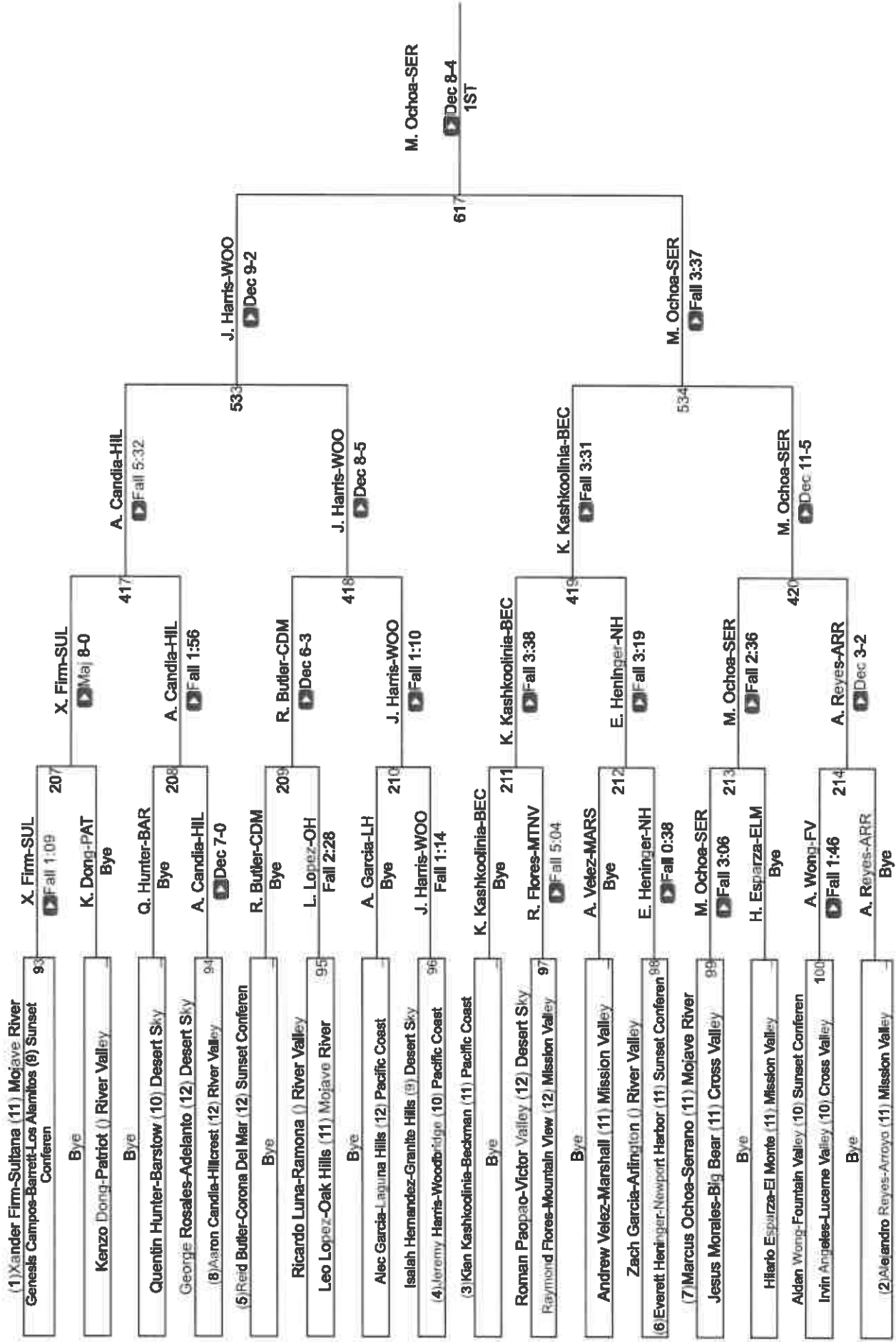

CIF Qualifier 285

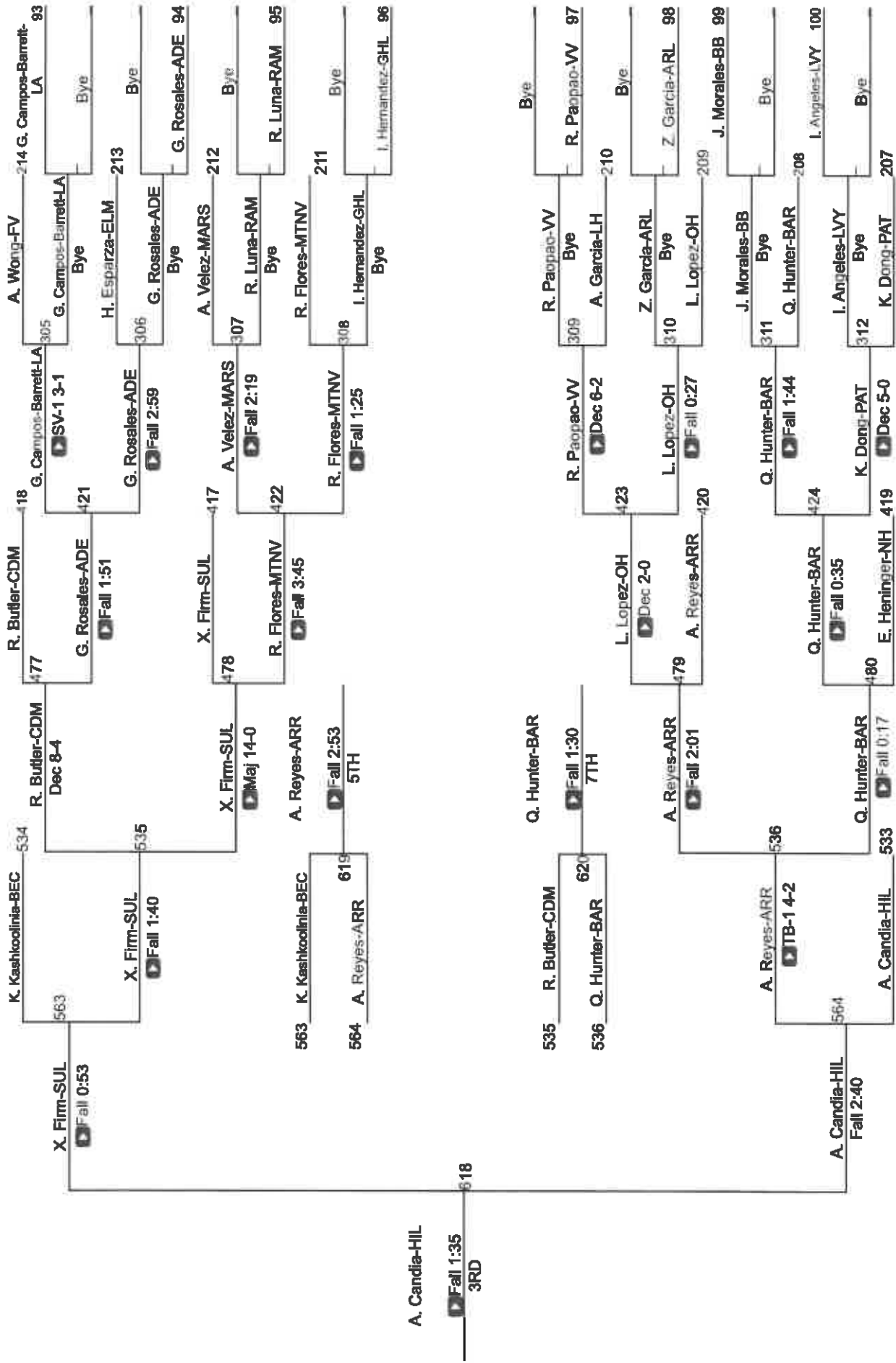

CIF SS Boys Individuals

Northern Division

Sonora High School

February 9-10, 2024



Lower Weight MVP

Jacob Bell
Etwanda
138 Pounds

Upper Weight MVP

Kayden Cartee
Mayfair
215 Pounds

Placers			150 Pounds			Team Score Final		
106 Pounds			1st	Sean Otero	Norwalk	1	Mayfair	220
1st	Mason Box	Canyon	2nd	James Holiday	Esperanza	2	Etwanda	188
2nd	Isalah Cruz	Mayfair	3rd	Santiago Loera	Etwanda	3	Esperanza	178.5
3rd	Kelly Brown	West Torrance	4th	Jake Jelus	Rancho Cucamonga	4	Villa Park	133.5
4th	Marchello Celavitta	Esperanza	5th	Turner Yanagisawa	Mayfair	5	El Dorado	124.5
5th	Dylan Esquivel	El Dorado	6th	Chris Castellano	Anaheim	6	South Torrance	115
6th	Phoenix Cruz	La Mirada	7th	Dylan Thienngern	Cypress	7	Western	113
7th	Samuel Olivier	Notre Dame/Riv	8th	Miko Duterte	Upland	8	Damien	83
8th	Lorenzo Pastrana	Valencia Placentia				9	Cypress	92.5
						10	Sonora	87
113 Pounds						11	Canyon	84.5
1st	Caden Garriott	South Torrance	1st	Xingyu Chen	Los Osos	12	Downey	82
2nd	Jimmy Romero	Cypress	2nd	Logan Carrara	El Modena	13	Warren	77.5
3rd	Joseph Garcia	Magnolia	3rd	Matthew Leon	Foothill	14	La Mirada	72
4th	Sebastian Brooks	Mayfair	4th	Nathan Aceves	Brea Olinda	15	Yorba Linda	71.5
5th	Elias Rodriguez	La Habra	5th	Jake Felix	Downey	16	Norwalk	71
6th	Christian Gijon	La Mirada	6th	Ryan Galvan	Santa Rosa Academy	17	Rancho Cucamonga	68
7th	Maxx Diaz	Etwanda	7th	Malachi Alatorre	Western	18	West Torrance	66.5
8th	Leonardo Hernandez	Villa Park	8th	Ivan Torres	North Torrance	19	La Habra	60
						20	El Modena	58
120 Pounds						21	Valencia Placentia	57
1st	Isalah Quintero	El Dorado	1st	Evan Manzo	Etwanda	22	Brea Olinda	58
2nd	Jake Decker	Canyon	2nd	Anthony Caso	Damien	23	North Torrance	54.5
3rd	Luis Romero	Villa Park	3rd	Kashus Talauaga	Villa Park	24	Eisenhower	51
4th	Anthony Mason	La Mirada	4th	Angel Orozco	Western	25	Los Osos	51
5th	Noe Duarte	Downey	5th	Jimmy Buentello	Norwalk	26	Upland	45.5
6th	Jacob Solano	Etwanda	6th	Lyon Kwon	Sunny Hills	27	Fullerton	41.5
7th	Mason Barros-Santiago	North Torrance	7th	Payton Randolph	Yorba Linda	28	Sunny Hills	41
8th	Paul Romero	Western	8th	Eugene Escalona	La Mirada	29	Paramount	40.5
						30	Anaheim	40
126 Pounds						31	Santa Ana Valley	39
1st	James Ruiz	Esperanza	1st	Ammar Abohashim	Bellflower	32	Bellflower	37
2nd	Gael Delgado	Warren	2nd	Jose Nunez	Rialto	33	Rialto	36.5
3rd	Eteban Armenta	Mayfair	3rd	Luke Salcido	Villa Park	34	Santa Rosa Academy	34
4th	Azuan Gonzalez	Eisenhower	4th	Joseph Aguller	Santa Ana Valley	35	Lawndale	28
5th	Brandon Waller-Strauss	West Torrance	5th	Logan Jackson	Esperanza	36	Foothill	27
6th	Brandon Vihuan	Upland	6th	Robert Oropeza	Yorba Linda	37	Savanna	27
7th	Moses Correa	El Dorado	7th	Lenny Pena	Valencia Placentia	38	Cotton	25
8th	Benjamin Mejia	Etwanda	8th	Luka Castillo	Damien	39	Tustin	24.5
						40	Chino Hills	23
132 Pounds						41	Troy	23
1st	Isaac Gonzalez	Western	1st	Matthew Holiday	Esperanza	42	Magnolia	20
2nd	Vince Partington	Cypress	2nd	Ezekiel Ormsby	South Torrance	43	Pacific Garden Grov	20
3rd	Austin McSwain	Etwanda	3rd	Caden Arellano	Damien	44	Fontana	17
4th	Edgar Mora	Mayfair	4th	Jack Beard	Mayfair	45	Aquinas	16
5th	Jaden Broussard	Villa Park	5th	DeShawn Cobbs	Fullerton	46	Notre Dame/Riv	11
6th	Luke Jelus	Rancho Cucamonga	6th	Mike Lozano	Sonora	47	Hamilton	8
7th	Anthony Ruiz	Santa Ana Valley	7th	Luke Chiarini	Tustin	48	Nuview Bridge	7
8th	Joshua Lee	South Torrance	8th	Brian Valdespino	Downey	49	Dominguez	4
						50	CSDR	3
138 Pounds						51	Kennedy	3
1st	Jacob Bell	Etwanda	1st	Kayden Cartee	Mayfair	52	Loera	3
2nd	Mathius Garza	Eisenhower	2nd	Grady Lawson	El Dorado	53	San Jacinto Valley Ac	3
3rd	Shawn Torres	La Habra	3rd	James Flores	Western	54	Buena Park	0
4th	Maddox Hemera	Esperanza	4th	Moses Vaita	Etwanda	55	Gahr	0
5th	Leonardo Guerrero	Mayfair	5th	David Baxter	Sonora	56	Grand Terrace	0
6th	Andre Garcia	Savanna	6th	Santiago Salas	Yorba Linda	57	Torrance	-1
7th	Jacob De Leon	Upland	7th	Leonardo Betulga	South Torrance			
8th	Alex Jeha	Canyon	8th	Ryan Alba	Damien			
144 Pounds								
1st	Jayden Espinoza	Rancho Cucamonga	1st	Santiago Benitez	Villa Park			
2nd	Jude Holiday	Esperanza	2nd	Jon Silvestri	Yorba Linda			
3rd	Bradley Espinoza	Brea Olinda	3rd	Ezekiel Lucero	Damien			
4th	Anthony Peraza	Warren	4th	Daniel Torres	Mayfair			
5th	Elijah Robledo	Mayfair	5th	Demetrio Sandoval	Downey			
6th	Liam Kim	Sunny Hills	6th	Julian Gomez	Valencia Placentia			
7th	Gavin Tsukiyama	North Torrance	7th	Ray Zaimal	Canyon			
8th	Jason Castaneda	Etwanda	8th	Tim Carmona	Brea Olinda			

EIF SS Boys Individuals Northern Div

EIF Qualifier 106

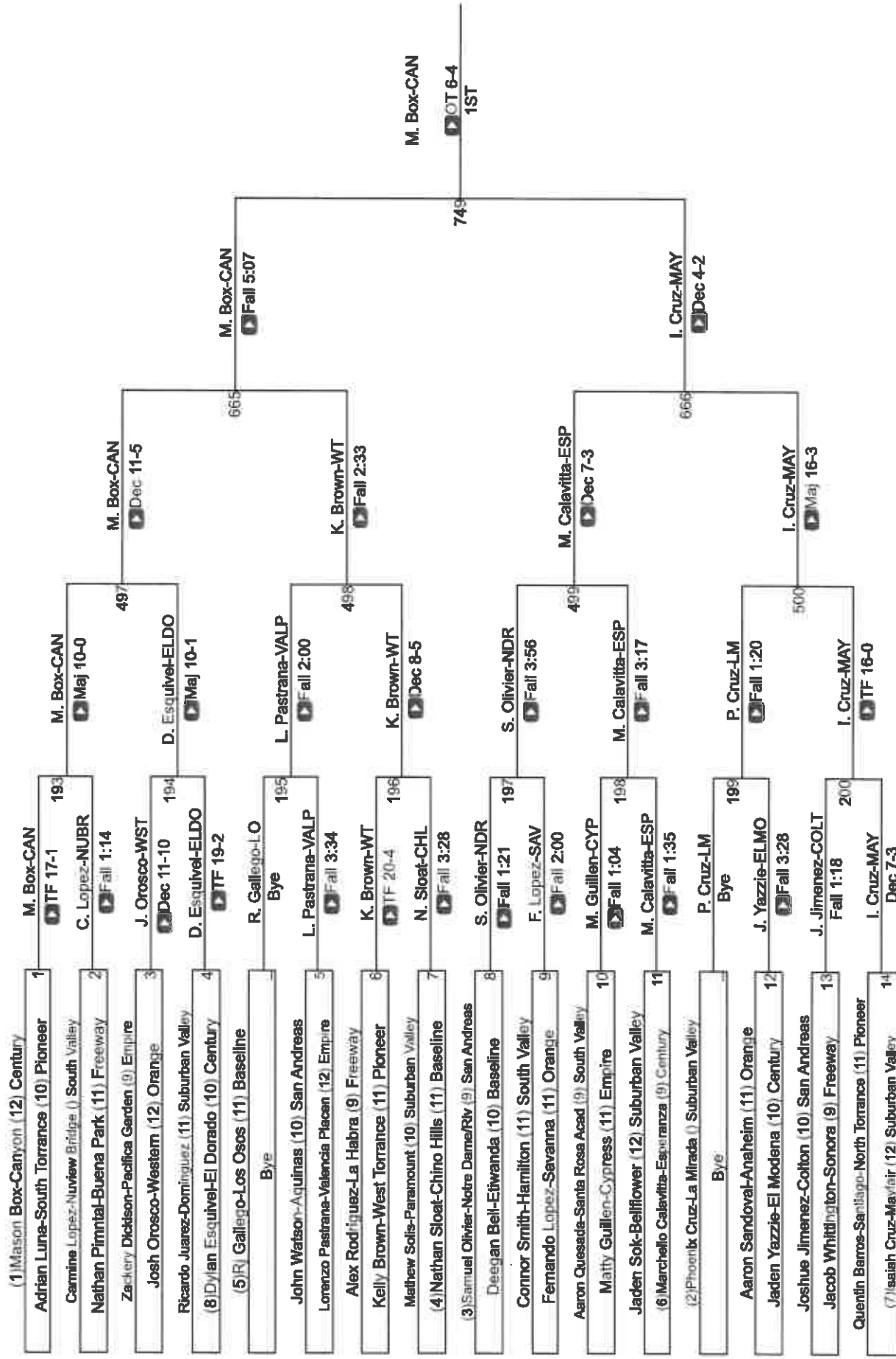

EIF Qualifier 106

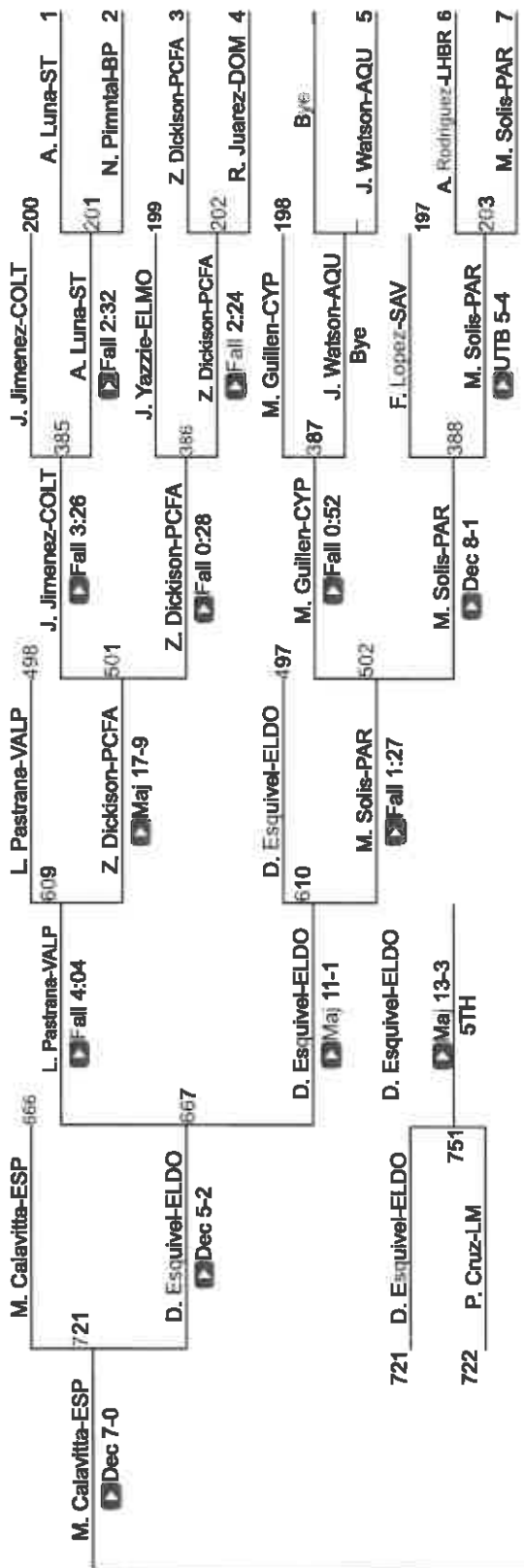

K. Brown-WT

▶ Dec 8-2
3RD

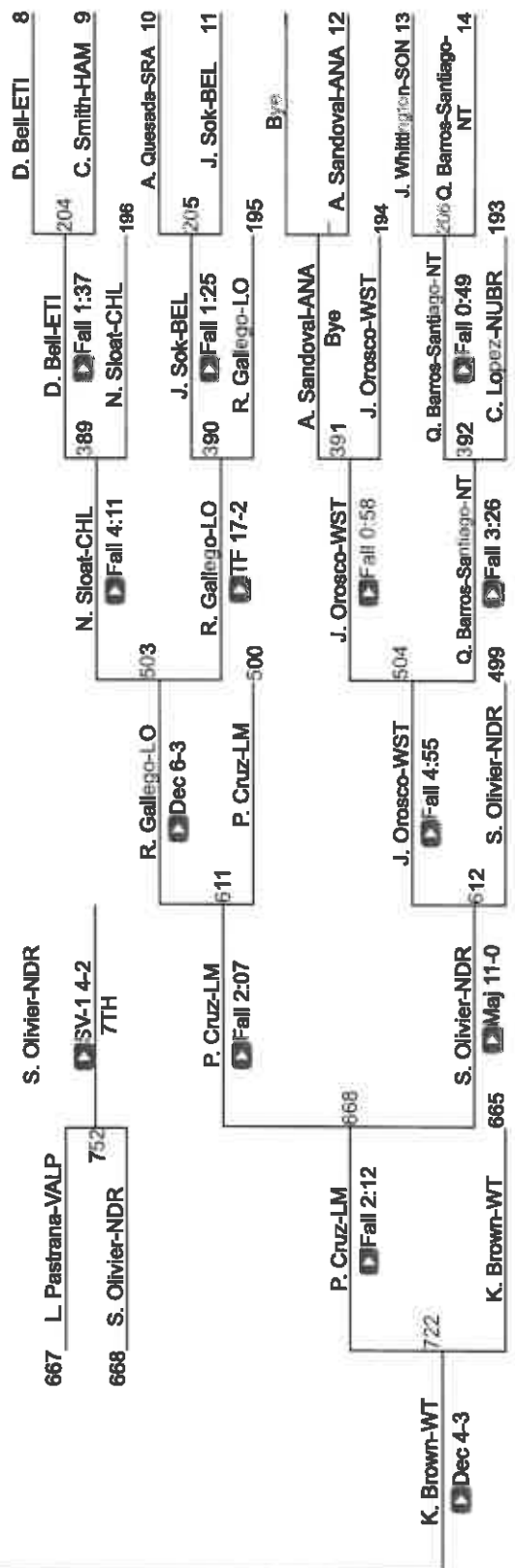

GIF SS Boys Individuals Northern Div

GIF Qualifier 113

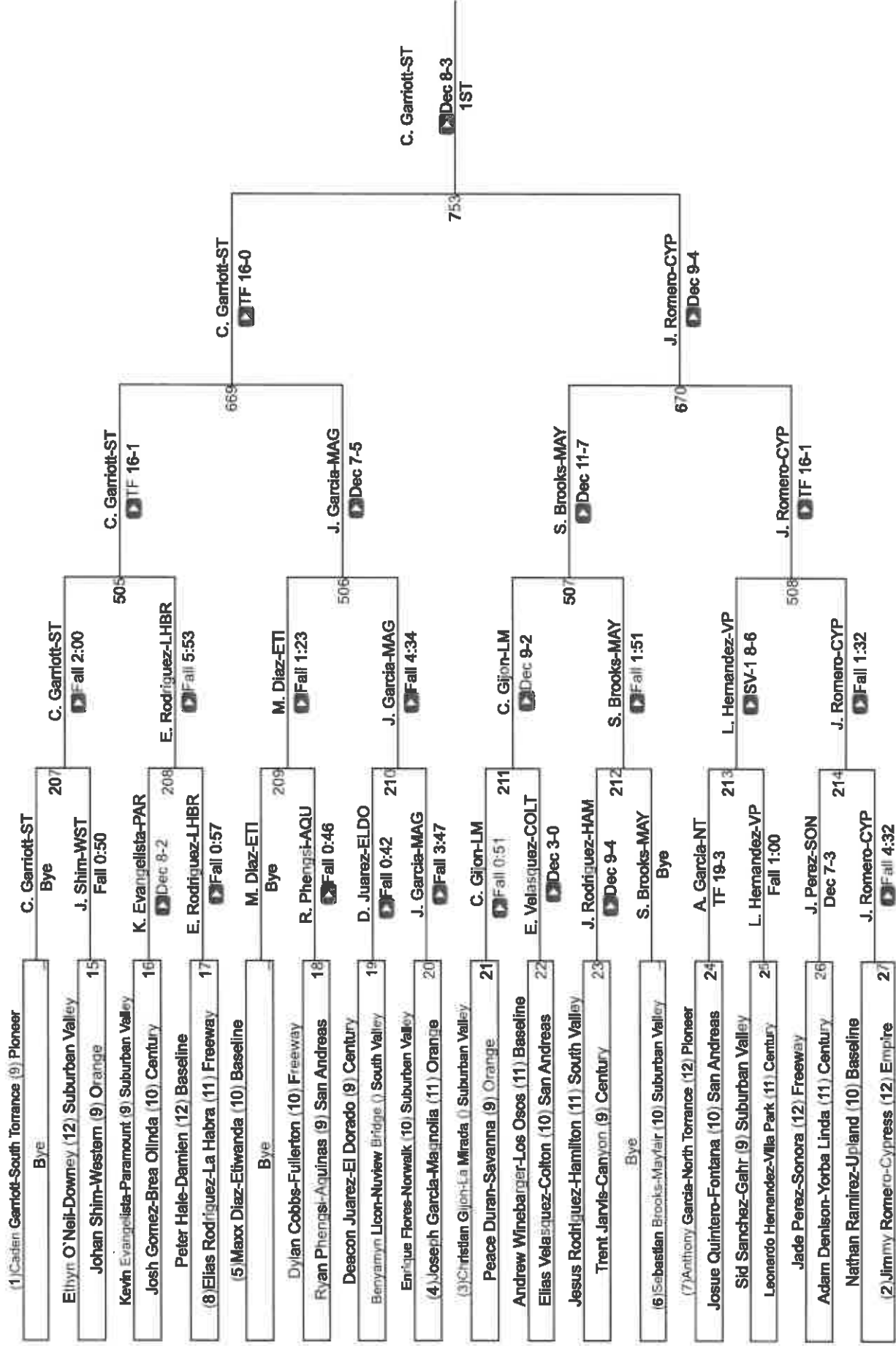

CIF Qualifier 113

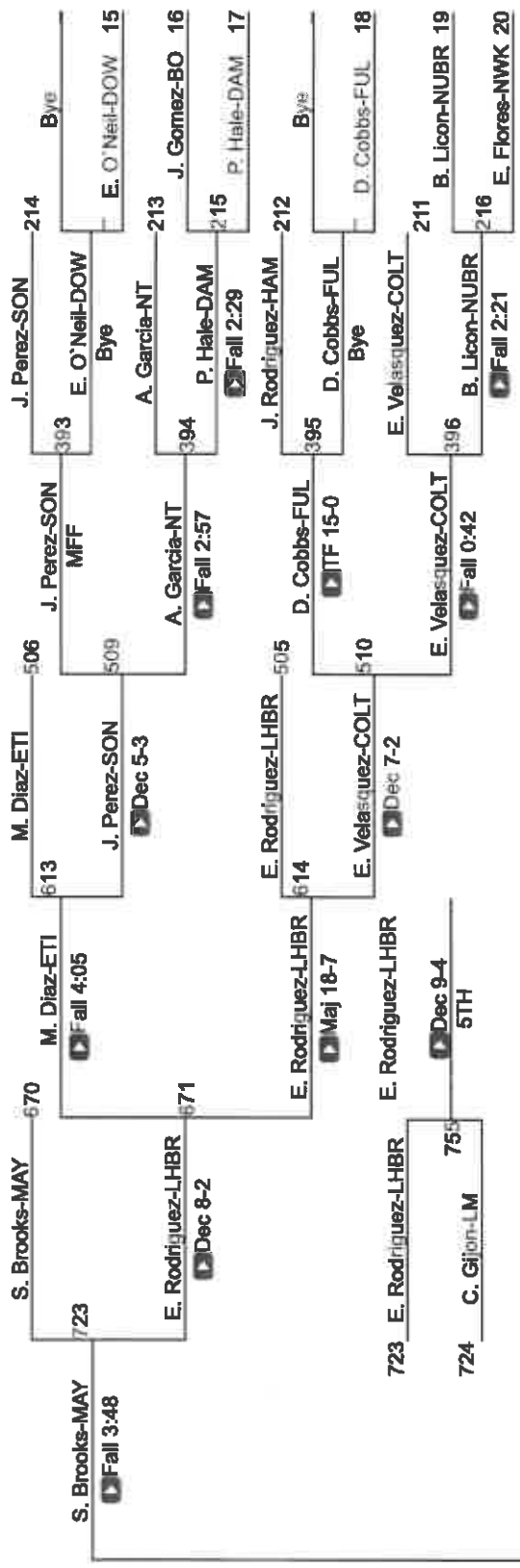

J. Garcia-MAG

Dec 6-2
3RD

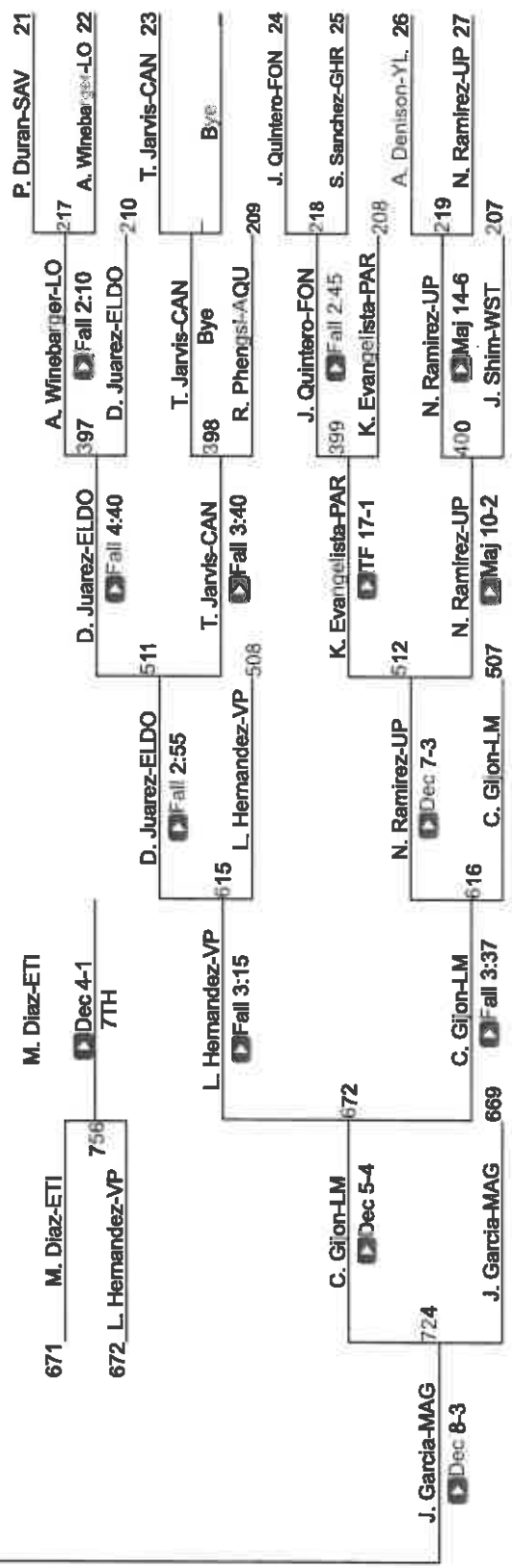

P. Duran-SAV 21

Dec 4-1
7TH

CIF SS Boys Individuals Northern Div

CIF Qualifier 120

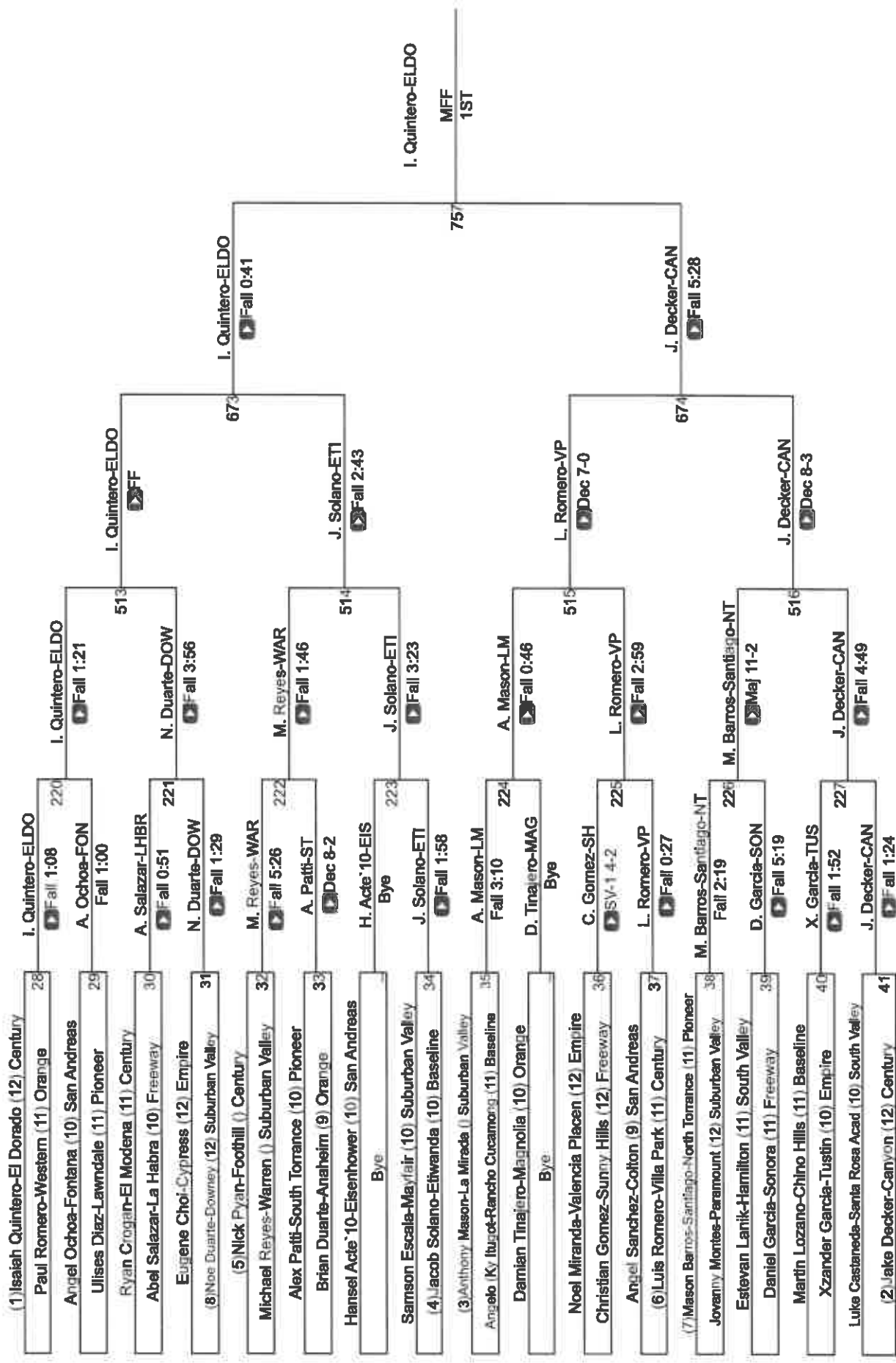

EIF SS Boys Individuals Northern Div

EIF Qualifier 126

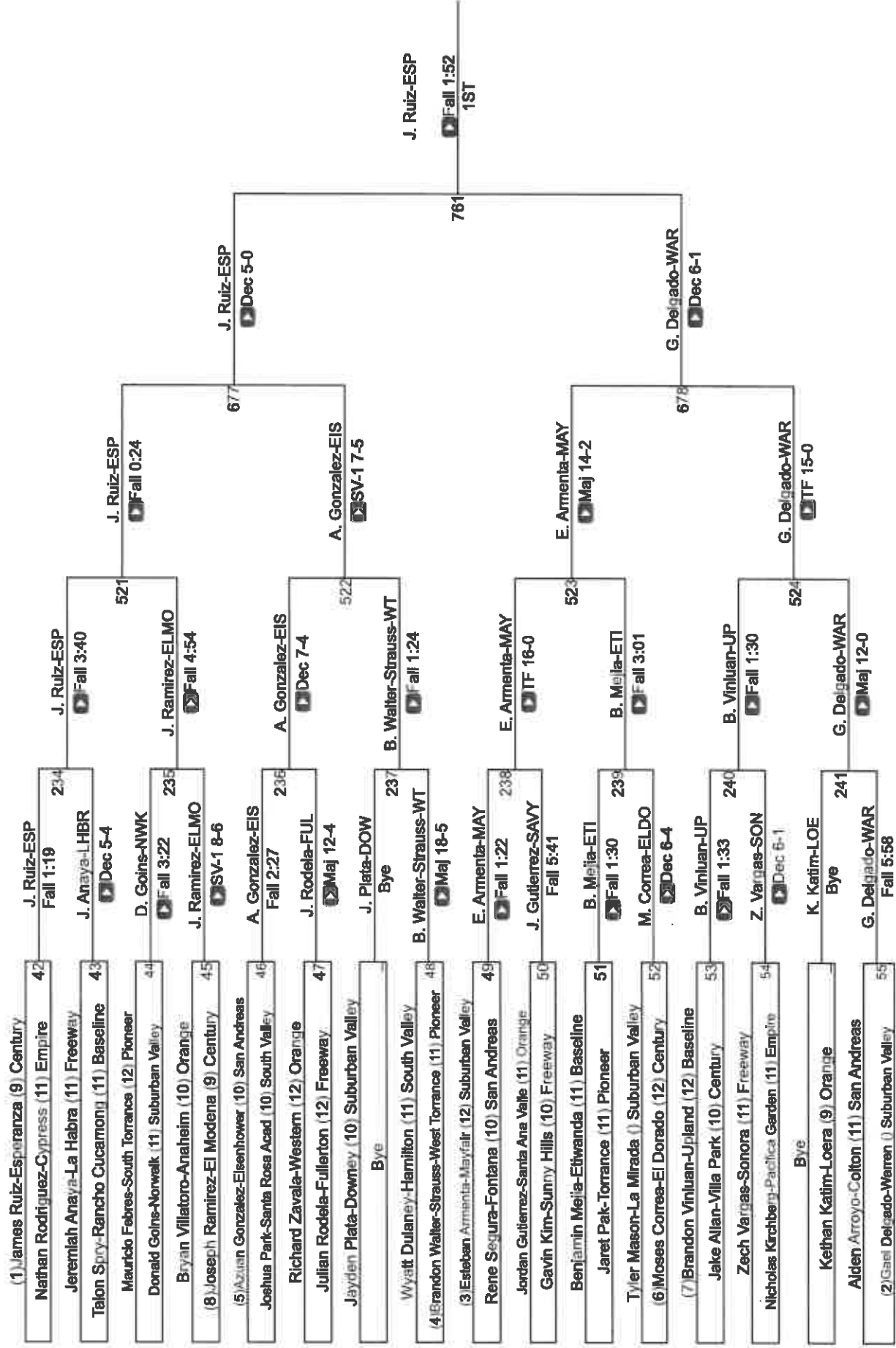

CIF Qualifier 126

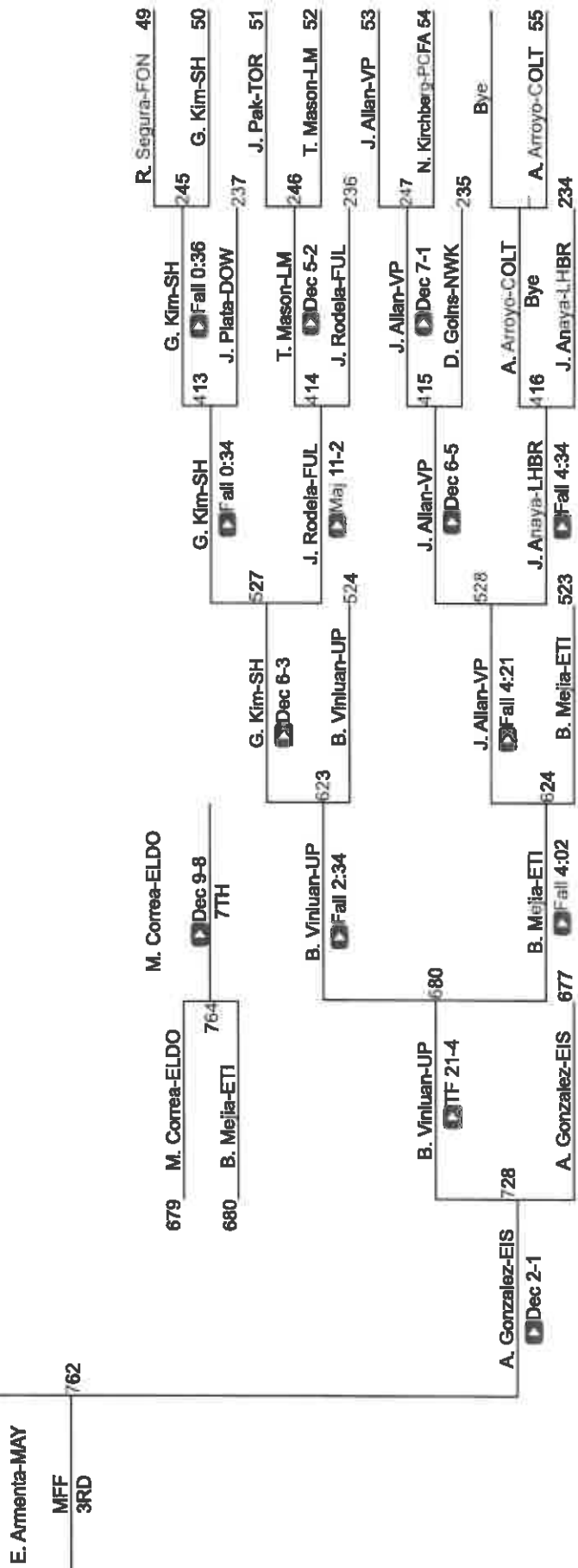
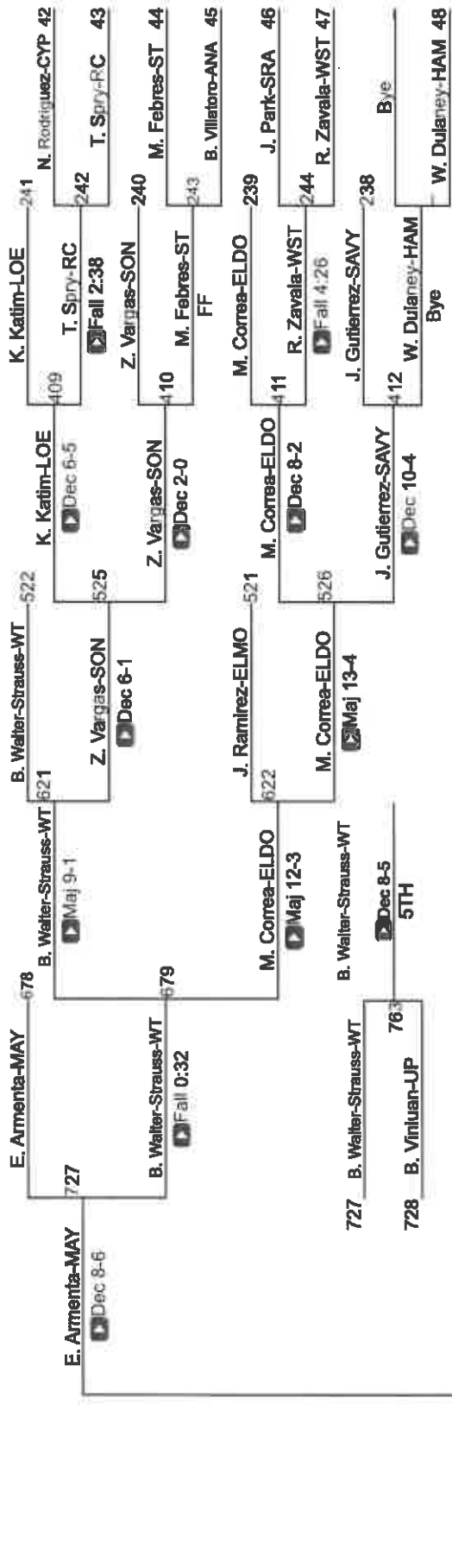

EIF SS Boys Individuals Northern Div

EIF Qualifier 132

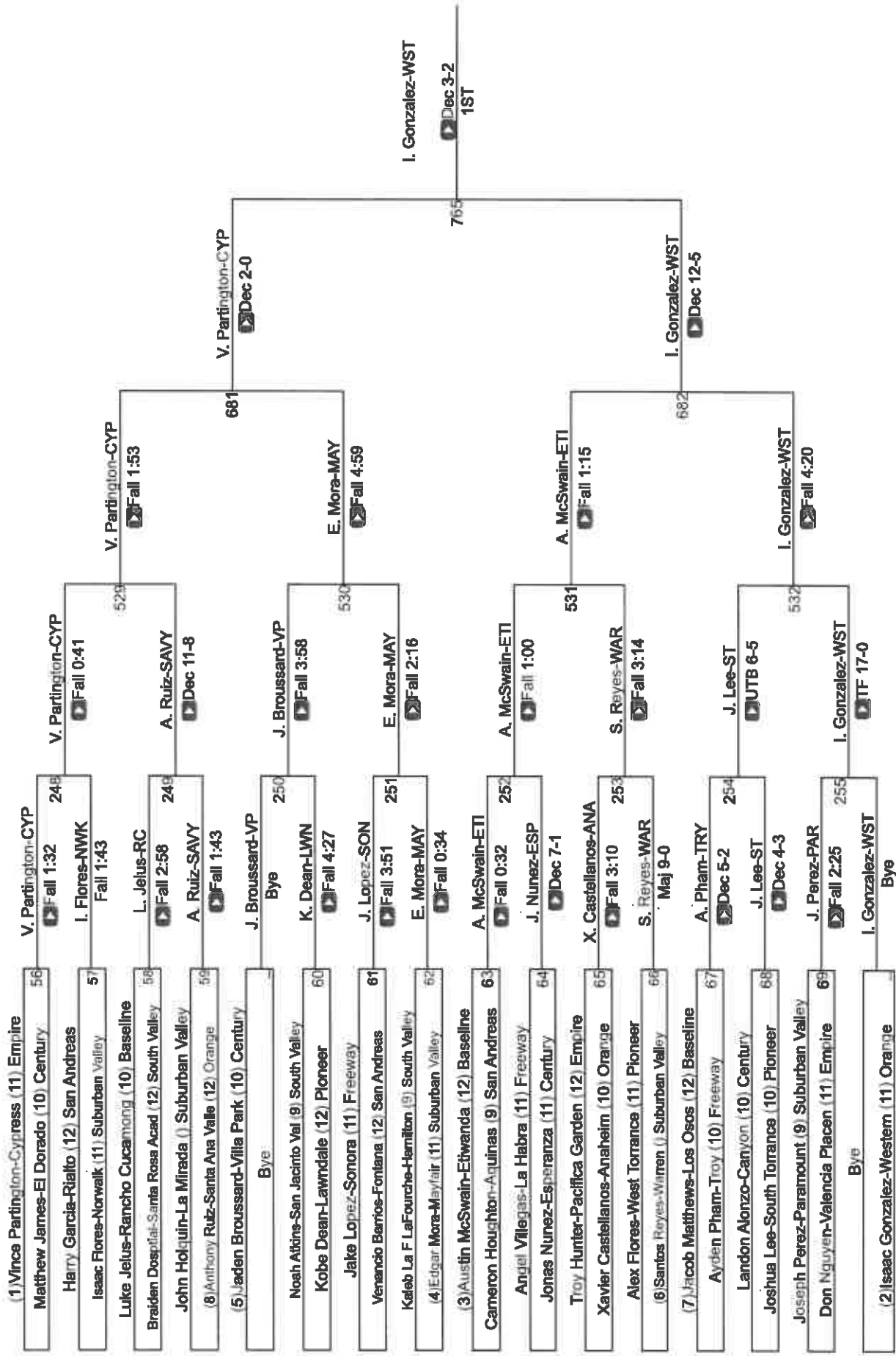

EIF Qualifier 132

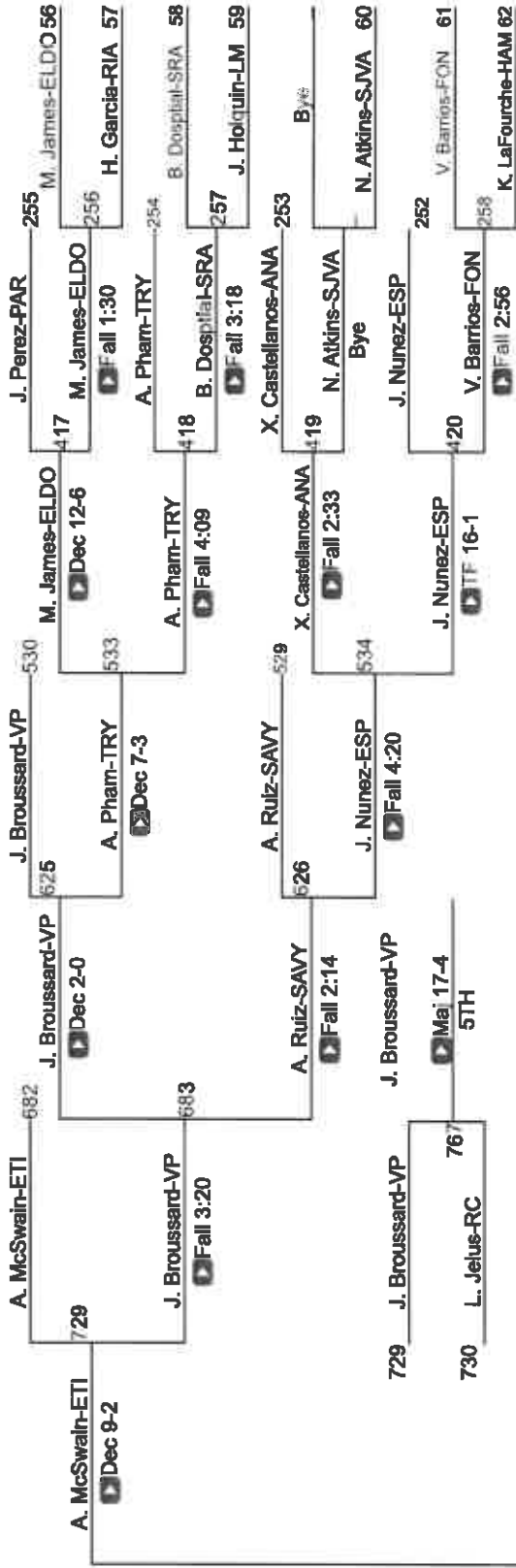

A. McSwain-ETI

Dec 5-2
3RD

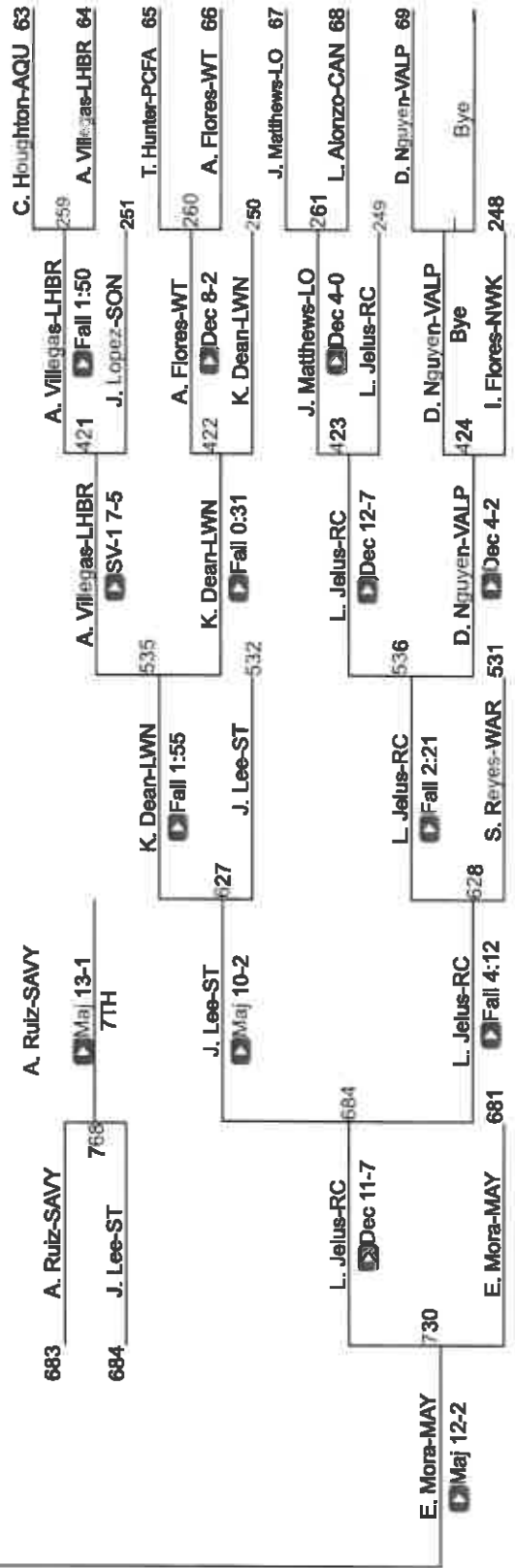

C. Houghton-AQU 63

A. Villegas-LHBR

A. Villegas-LHBR

J. Lopez-SON

T. Hunter-PCFA 65

A. Flores-WT

A. Flores-WT

K. Dean-LWN

K. Dean-LWN

J. Matthews-LO

J. Matthews-LO

L. Alonzo-CAN

L. Alonzo-CAN

D. Nguyen-VALP

D. Nguyen-VALP

I. Flores-NWK

I. Flores-NWK

Bye

Bye

EIF SS Boys Individuals Northern Div

EIF Qualifier 138

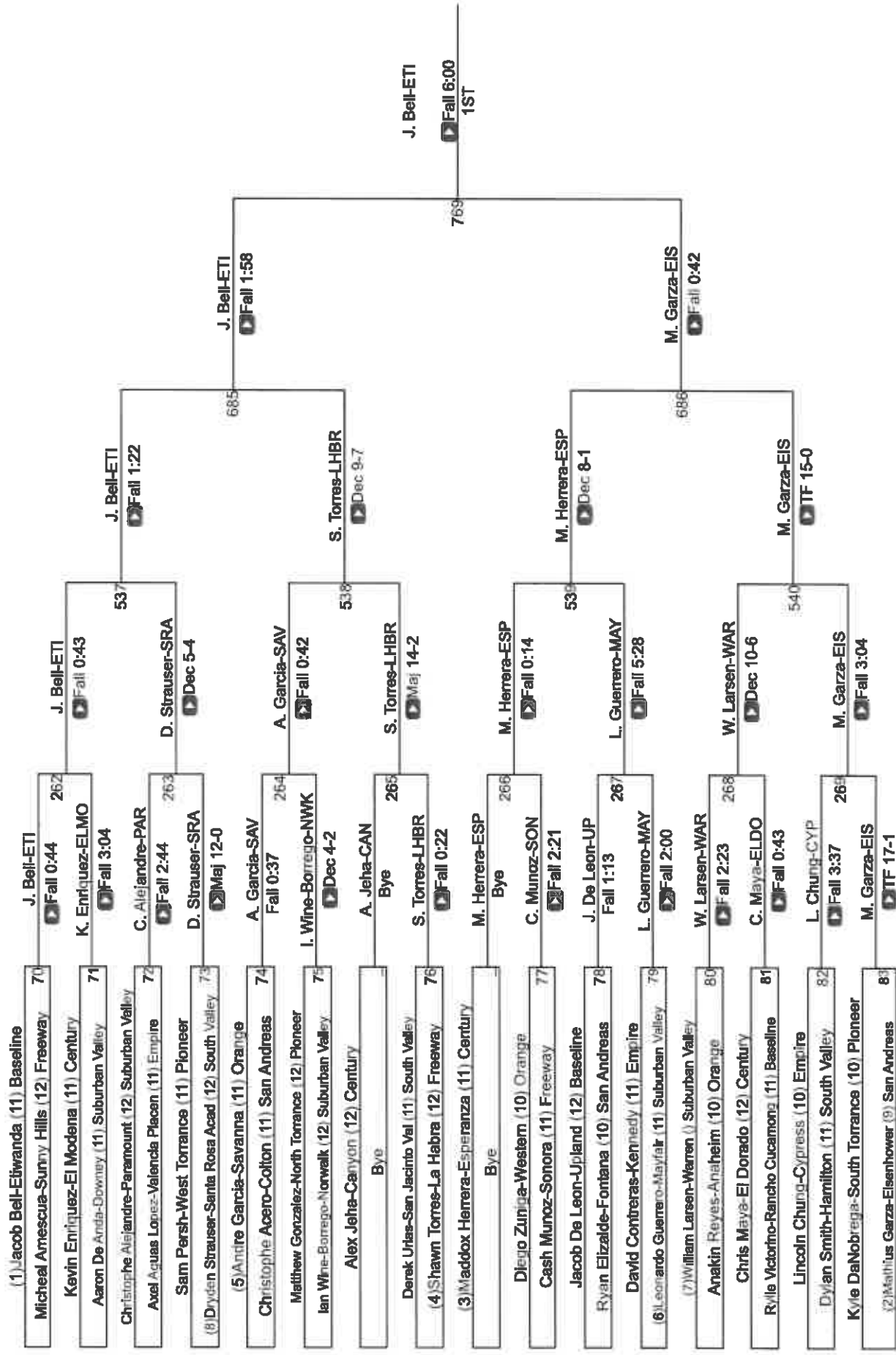

EIF SS Boys Individuals Northern Div

EIF Qualifier 144

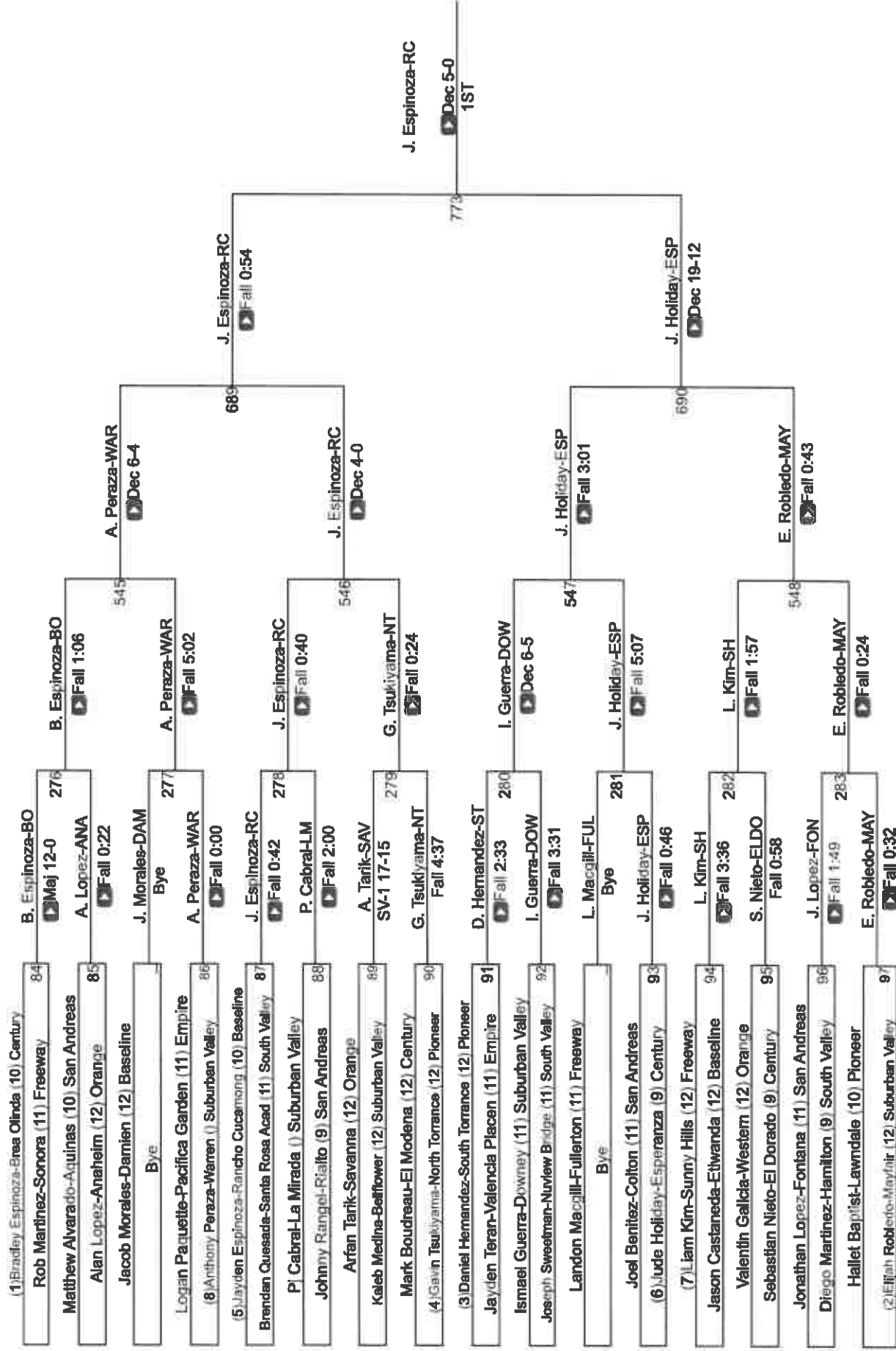

CIF Qualifier 150

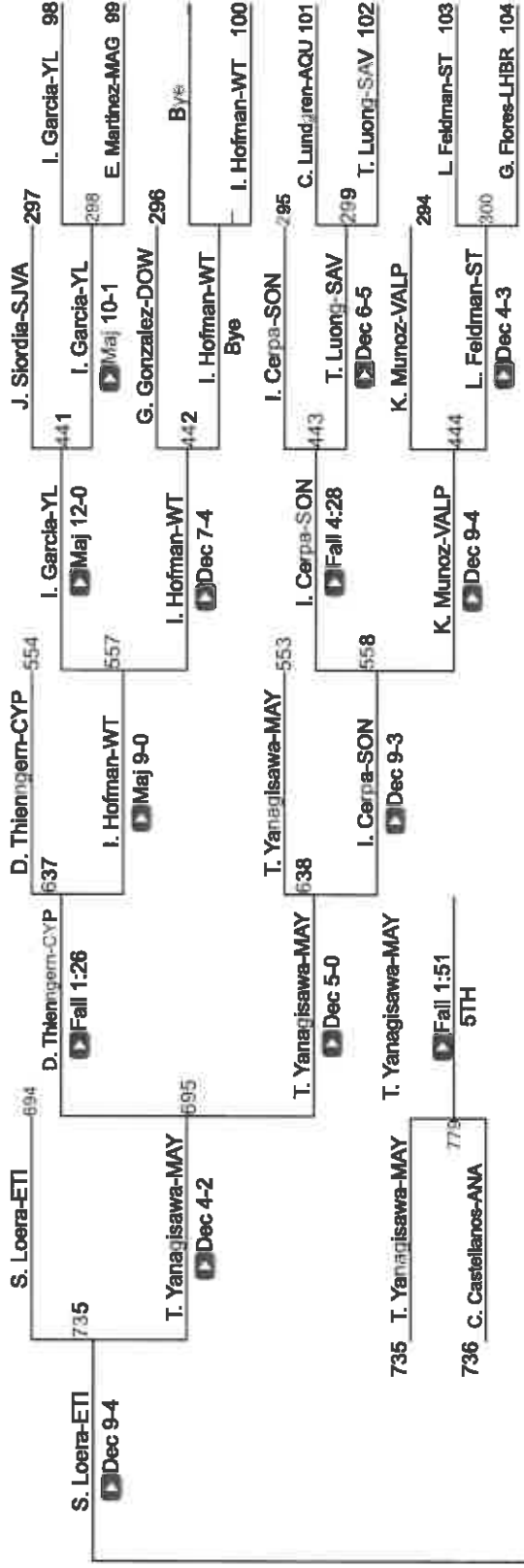

S. Loera-ETI

Dec 8-2
3RD

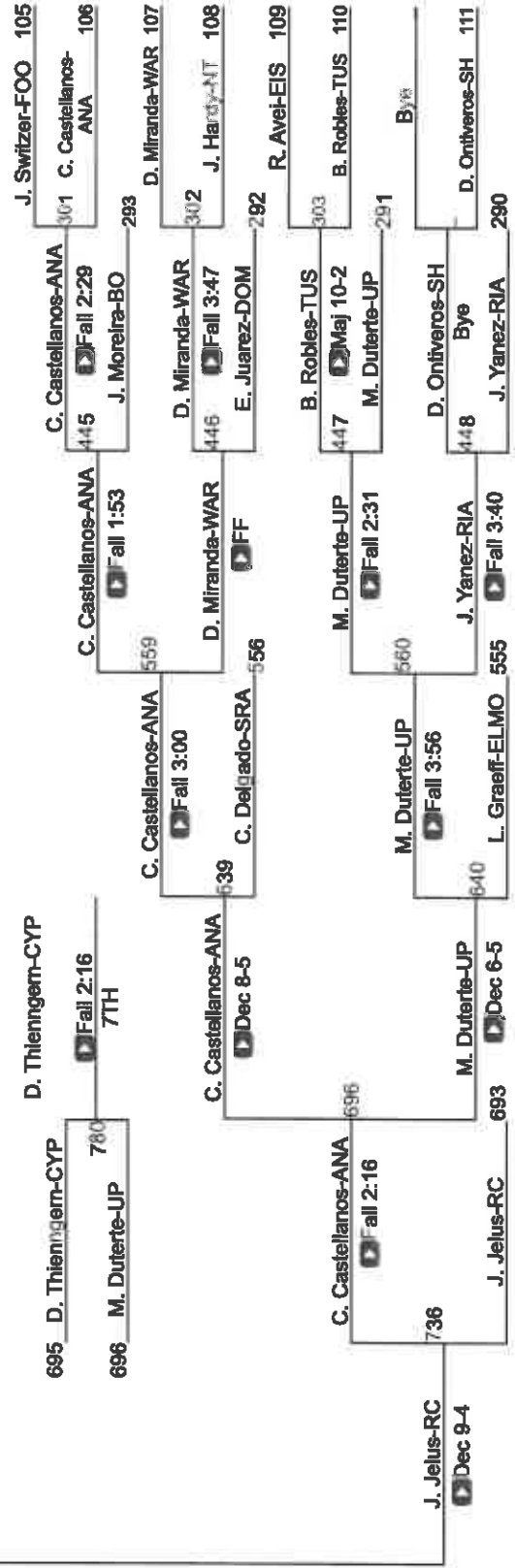

J. Switzer-FOO 105
 C. Castellanos-ANA 301 vs C. Castellanos-ANA 106
 J. Moreira-BO 293 vs D. Miranda-WAR 107
 D. Miranda-WAR 342 vs J. Hardy-NT 108
 E. Juarez-DOM 292 vs R. Avel-EIS 109
 B. Robles-TUS 303 vs B. Robles-TUS 110
 M. Duterte-UP 291 vs Bye
 D. Oniveros-SH vs D. Oniveros-SH 111
 J. Yanez-RIA 290 vs J. Yanez-RIA 111

EIF SS Boys Individuals Northern Div

EIF Qualifier 157

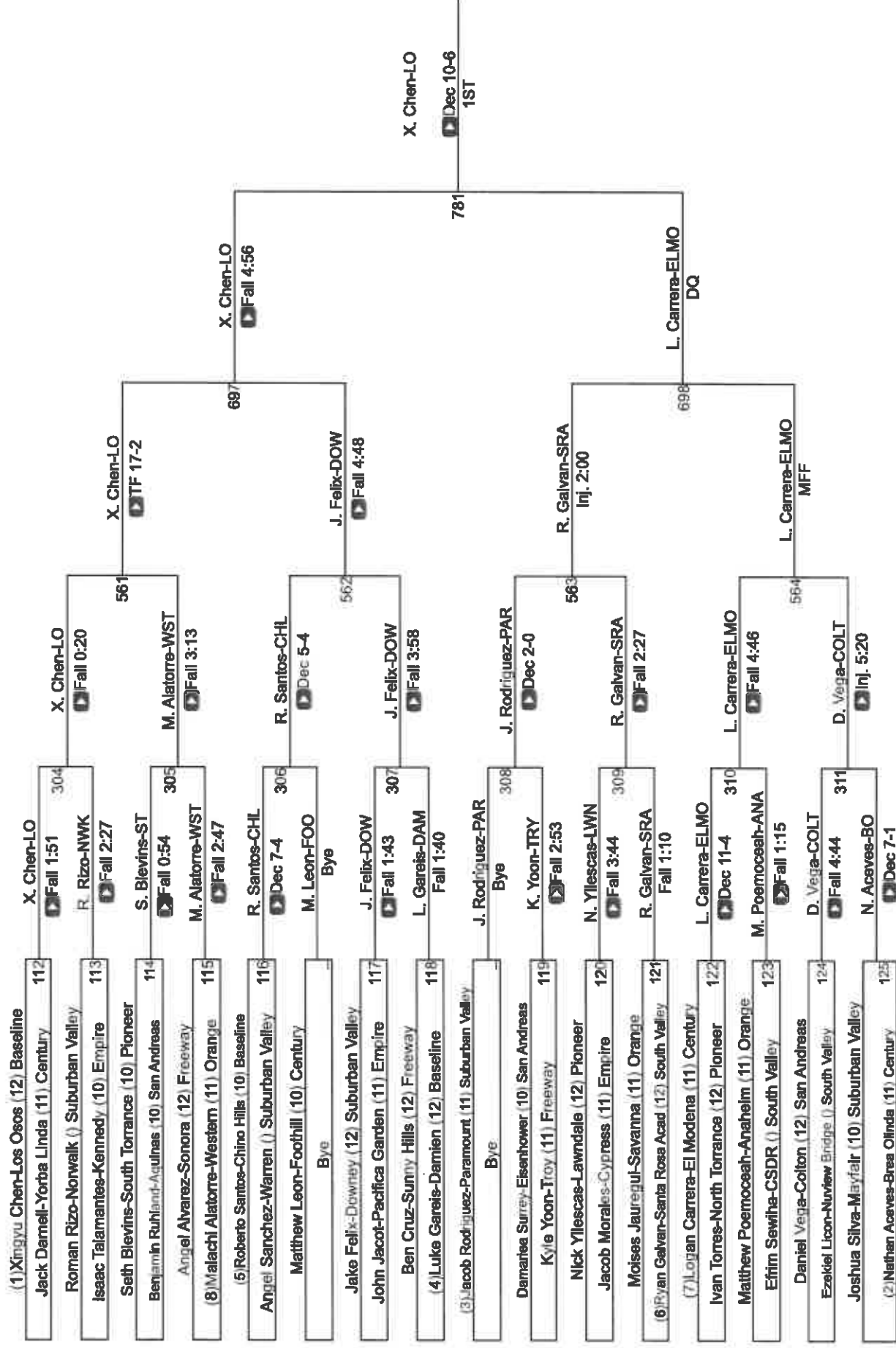

CIF Qualifier 157

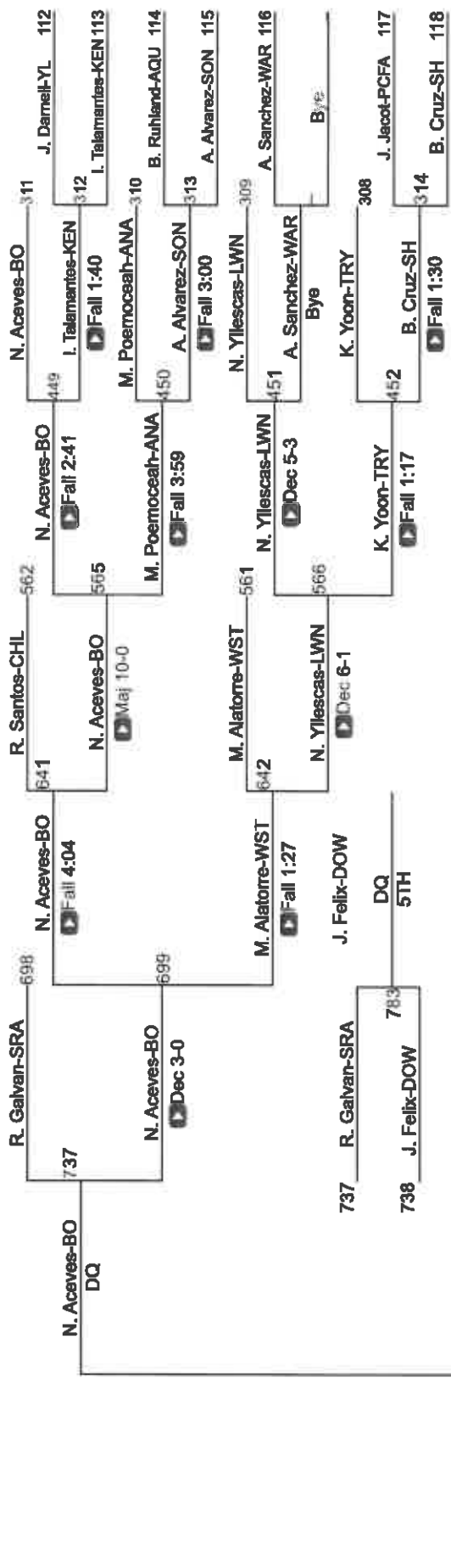

M. Leon-FOO

[X] Dec 5-0
3RD

GIF SS Boys Individuals Northern Div

GIF Qualifier 165

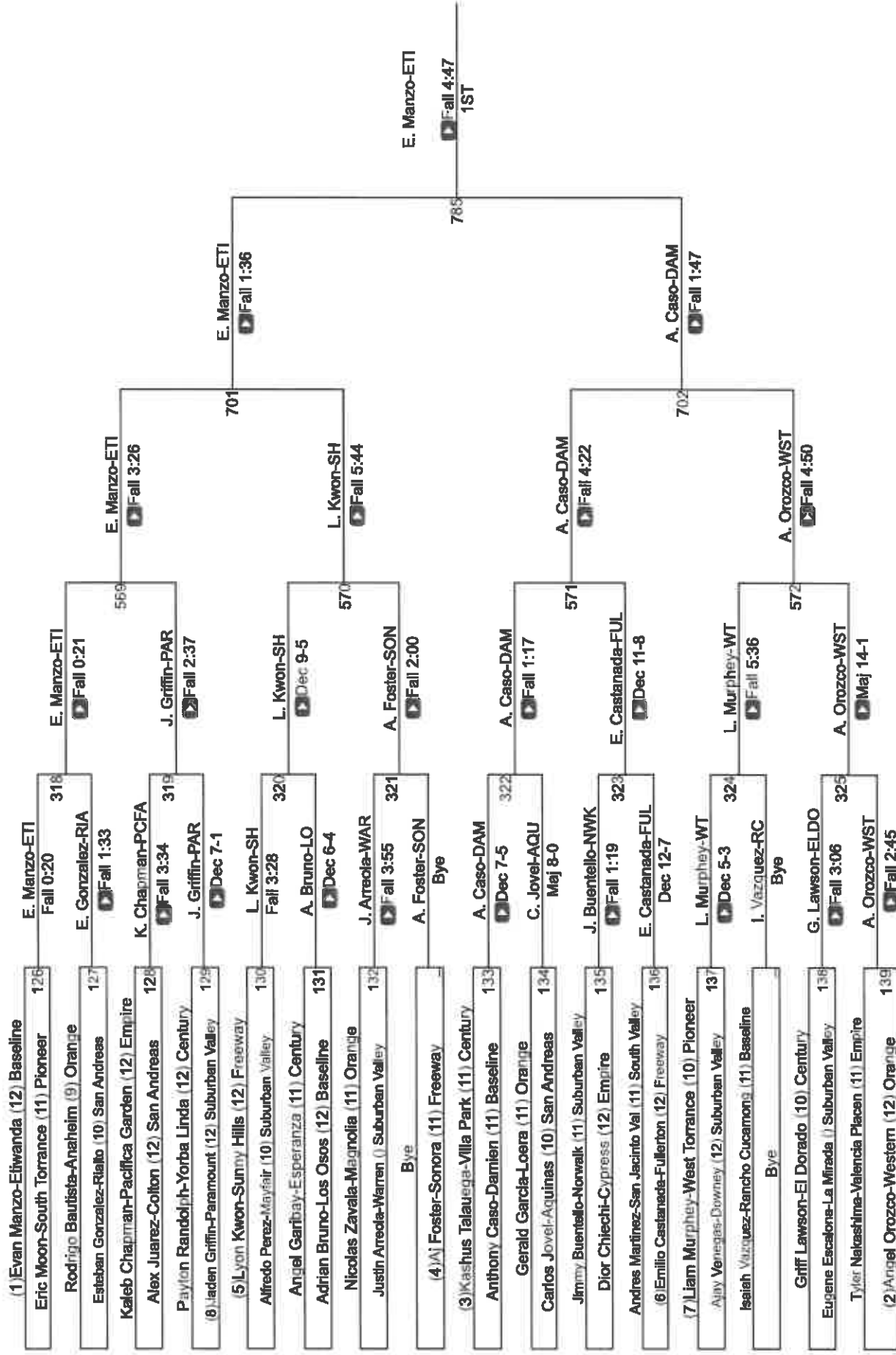

CIF Qualifier 165

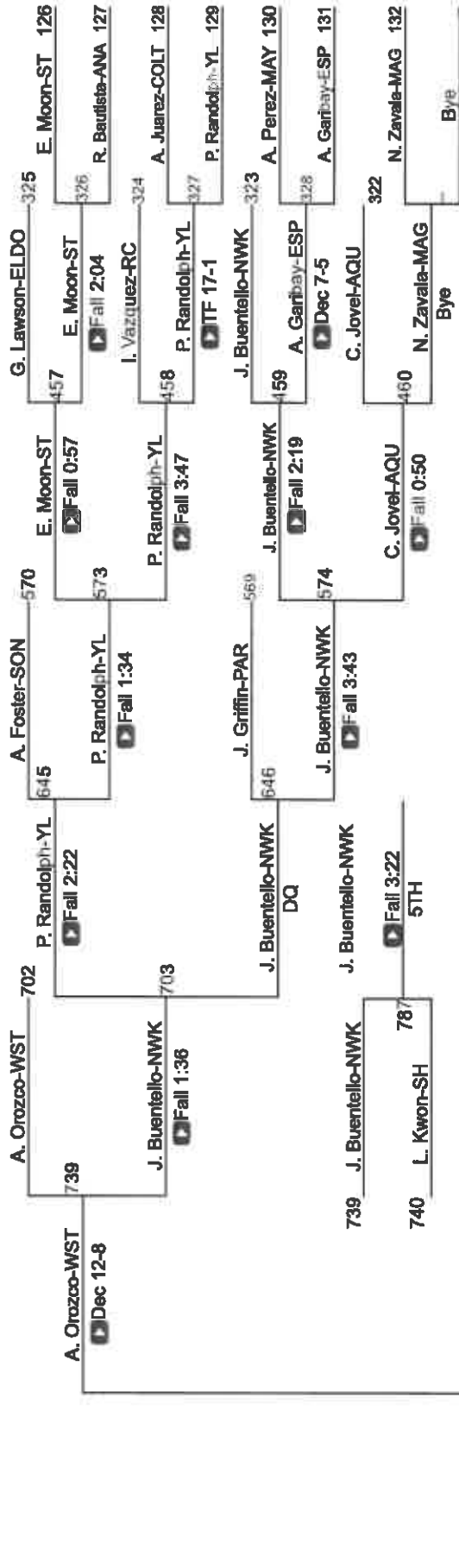

K. Talauega-VP

786
Fall 2:55
3RD

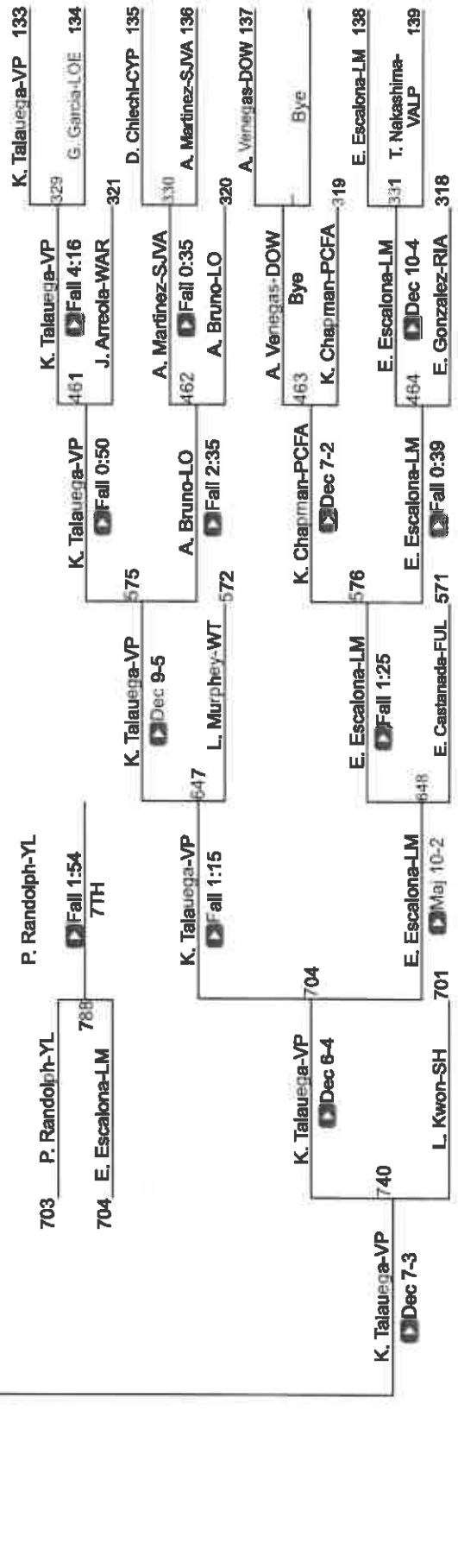

K. Talauega-VP

786
Fall 2:55
3RD

EIF SS Boys Individuals Northern Div

EIF Qualifier 175

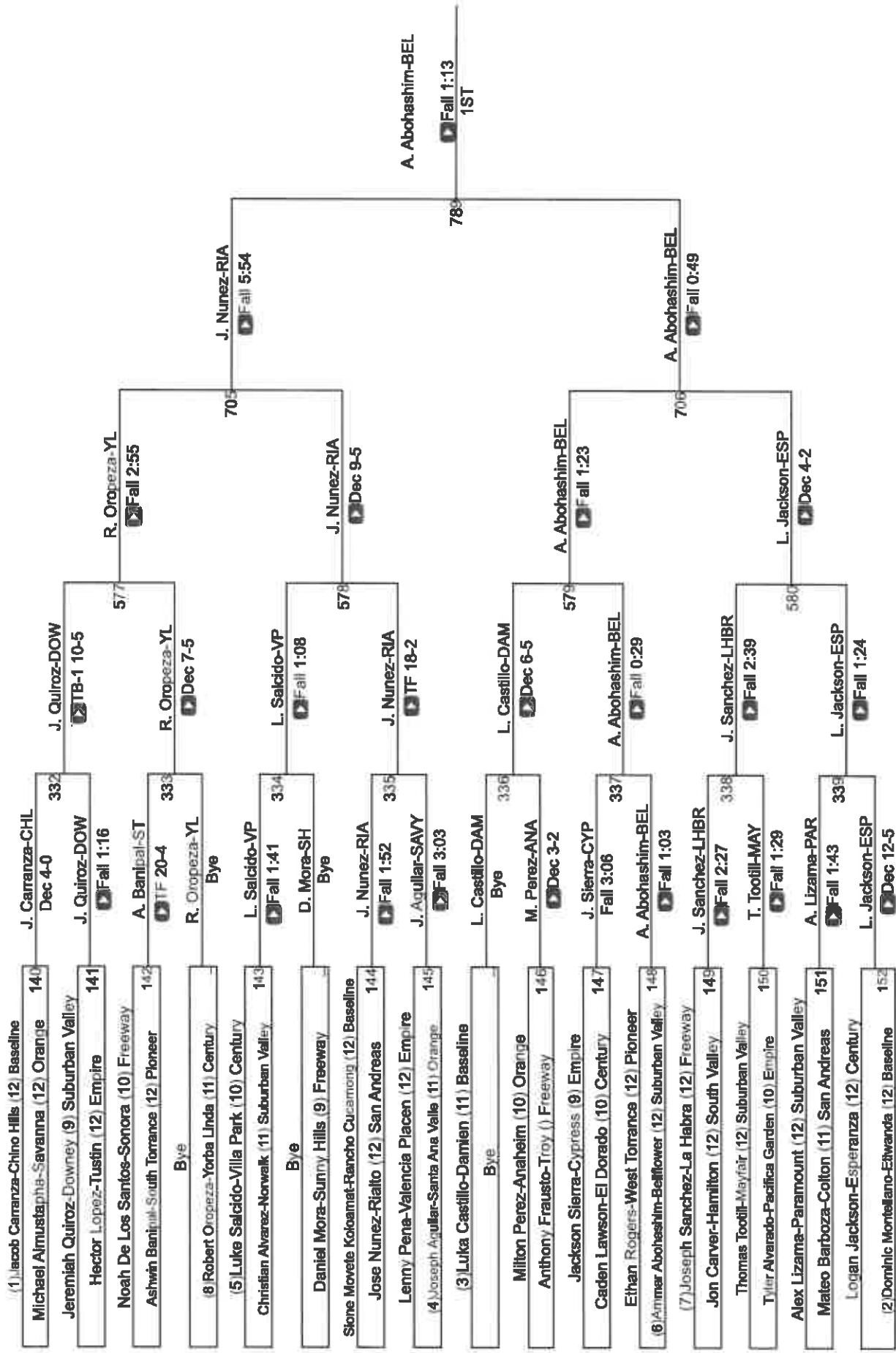

CIF SS Boys Individuals Northern Div

CIF Qualifier 190

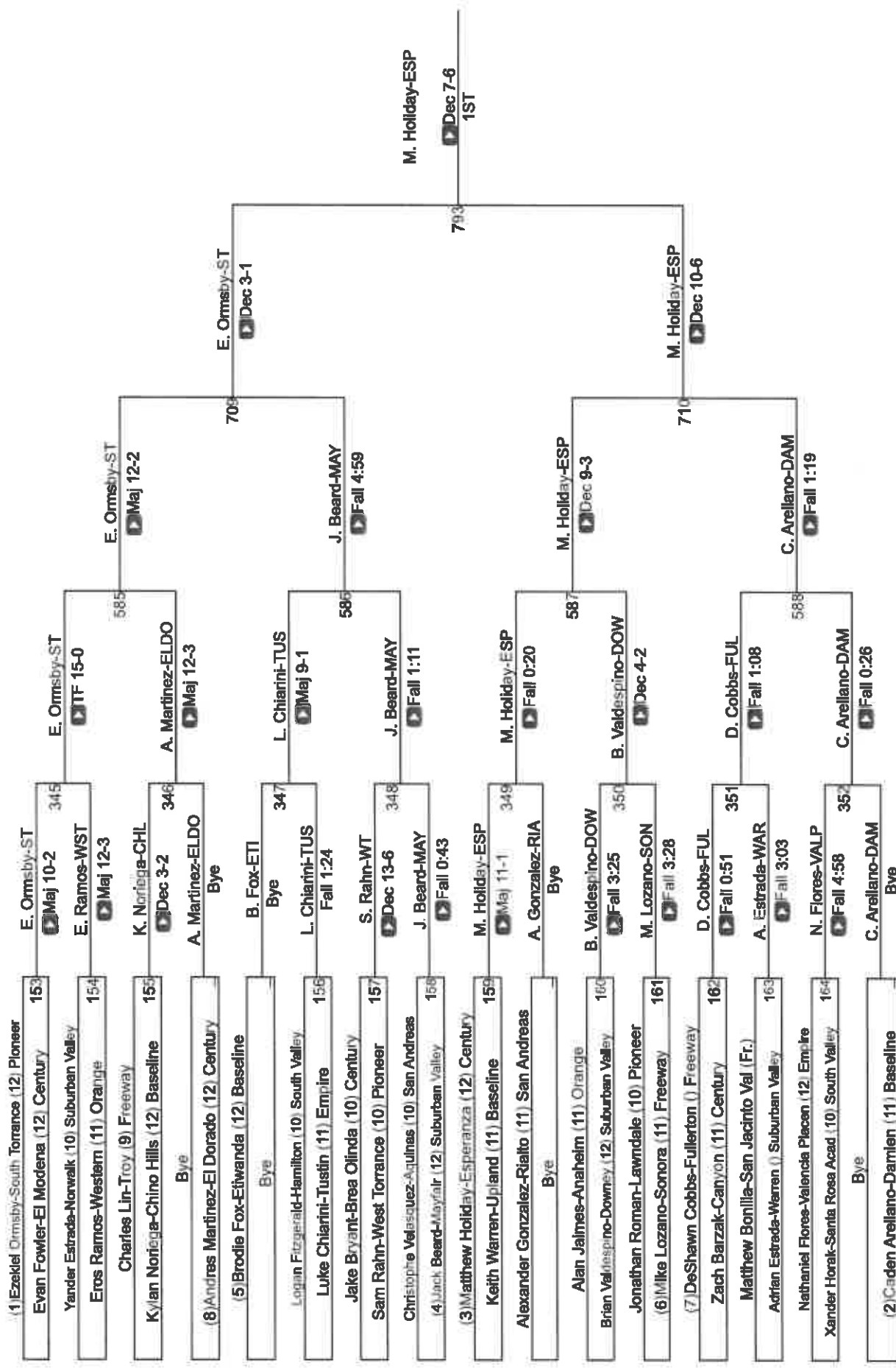

EIF Qualifier 190

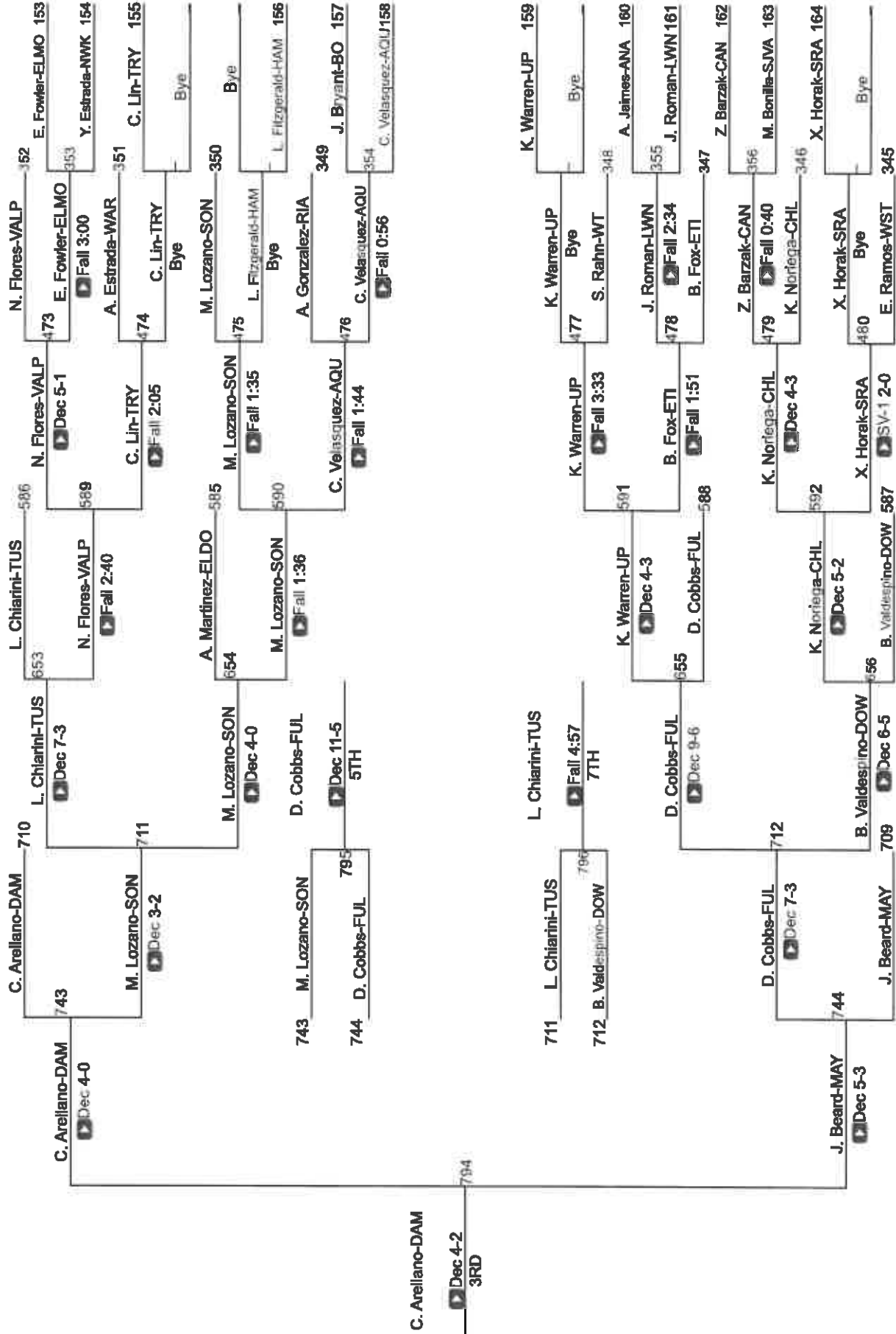

GIF SS Boys Individuals Northern Div

GIF Qualifier 215

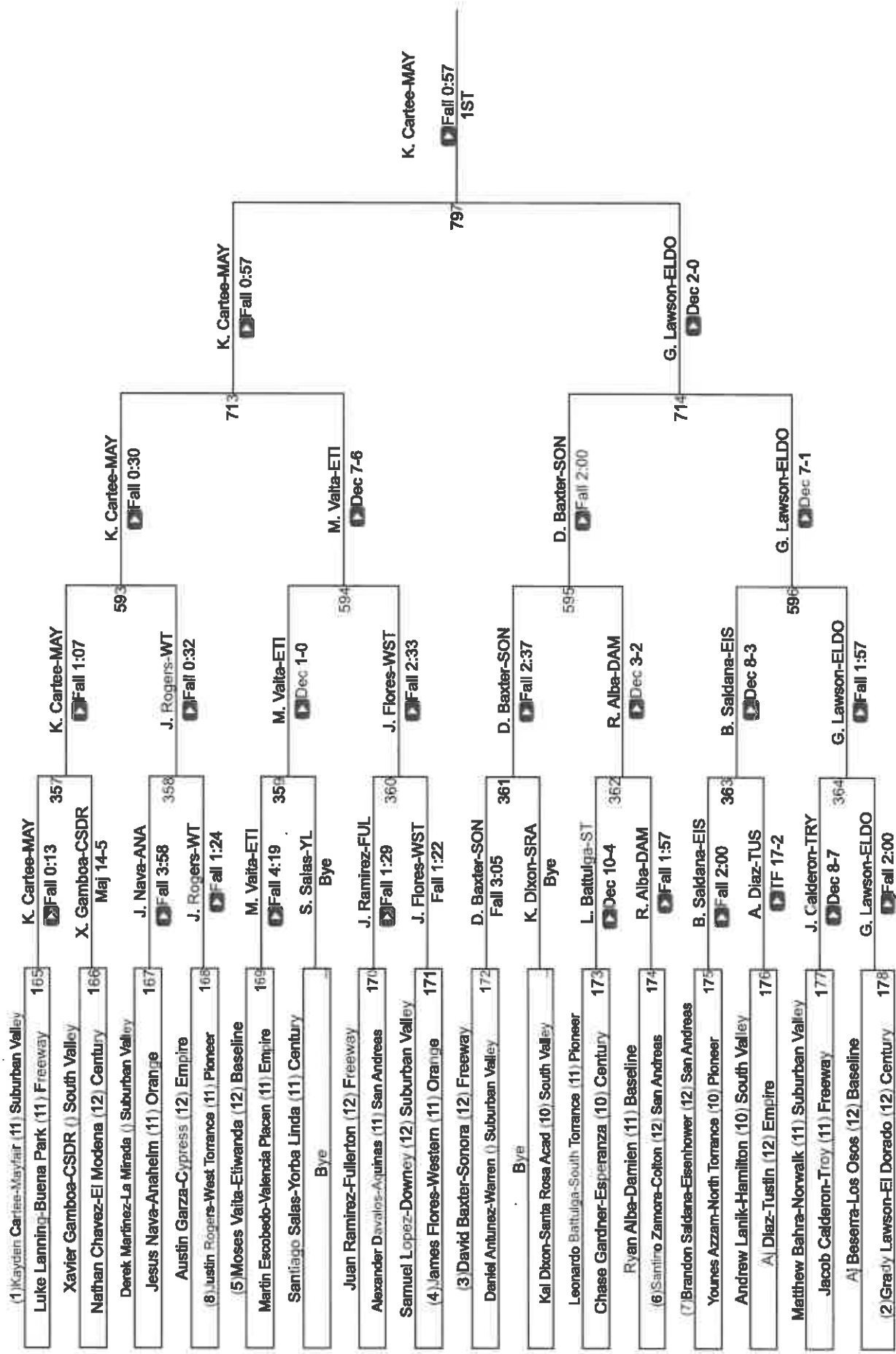

EIF Qualifier 215

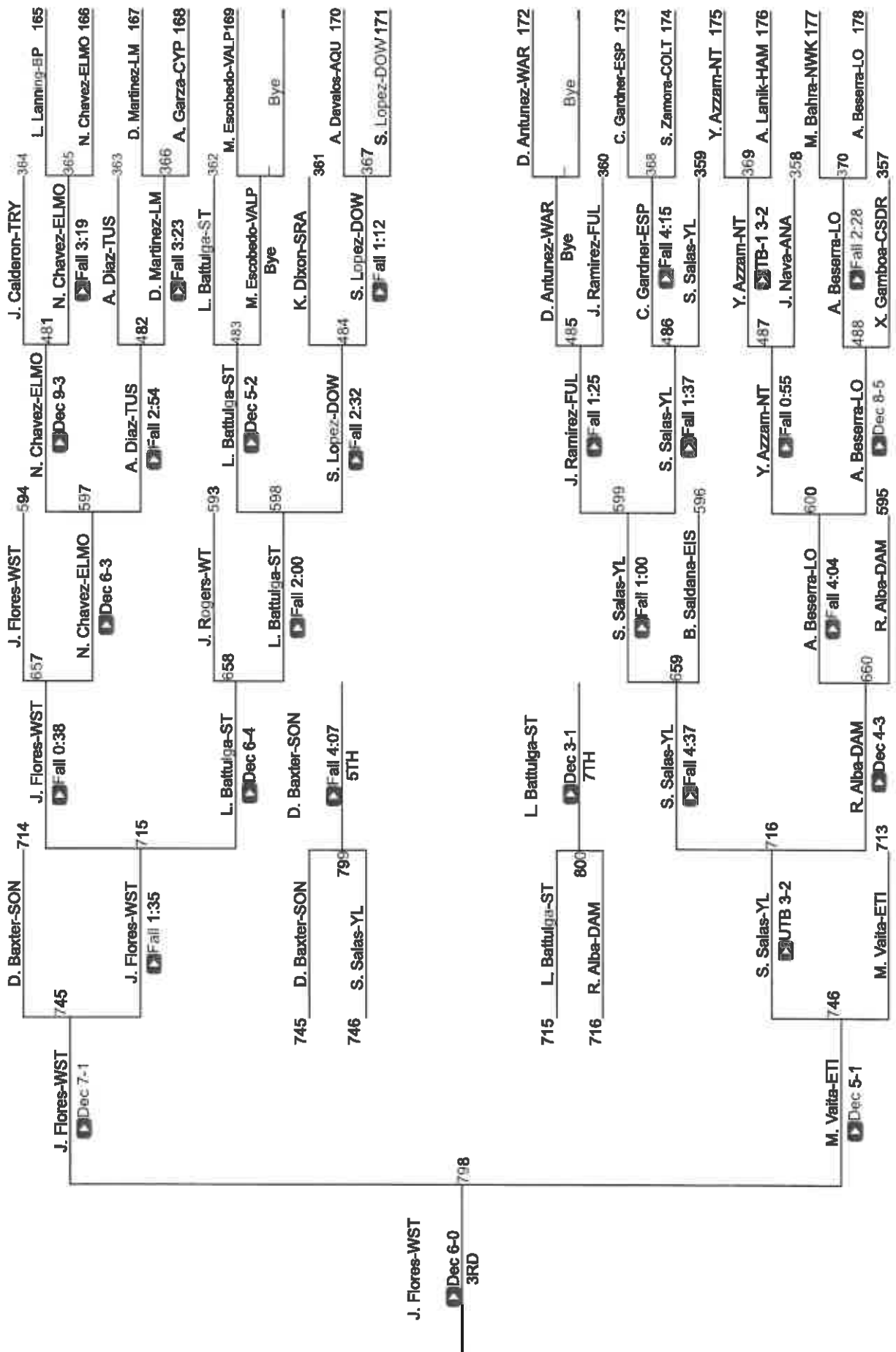

EIF SS Boys Individuals Northern Div

EIF Qualifier 285

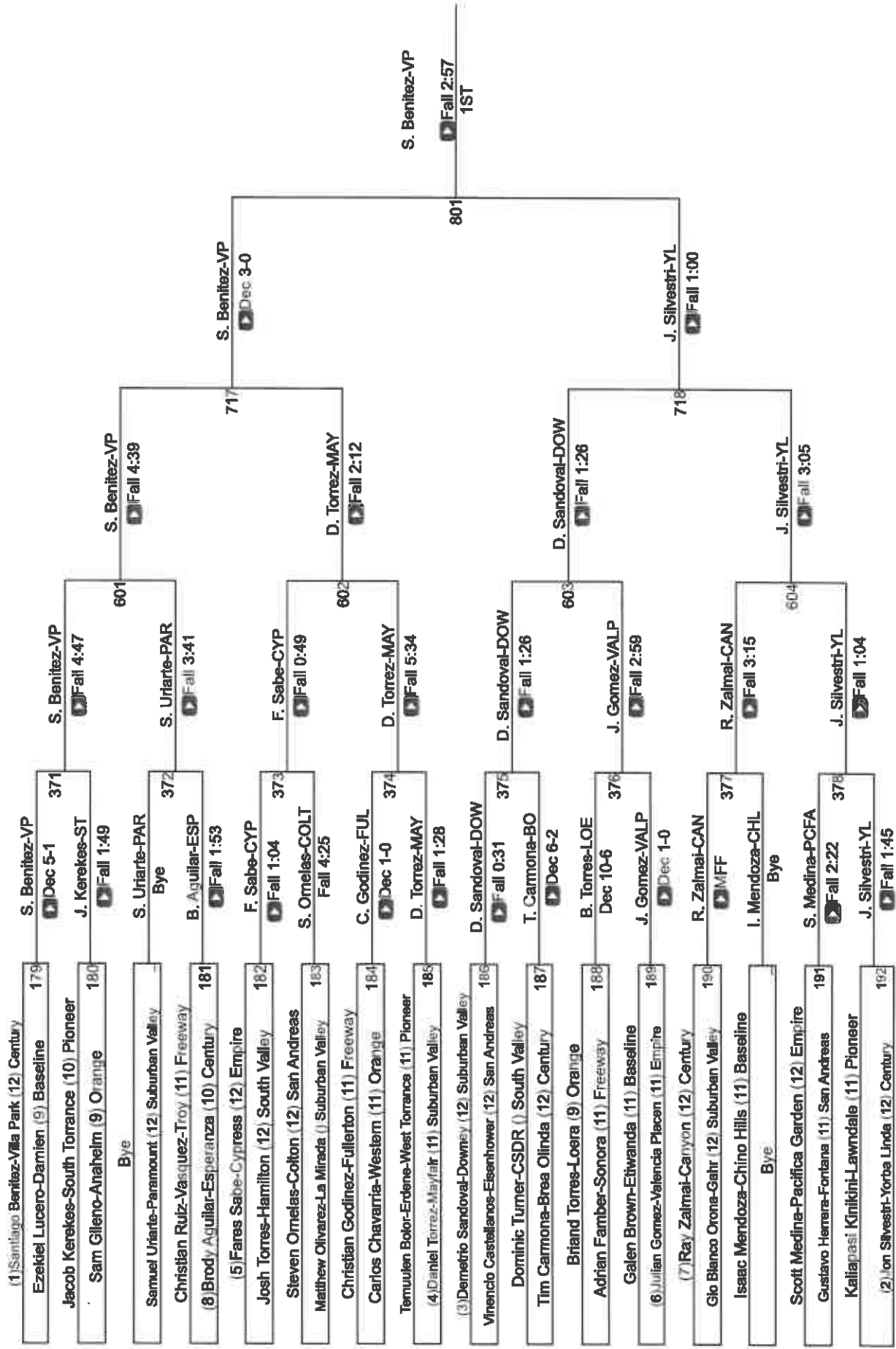

CIF SS Boys Individuals

Southern Division

Great Oak High School

February 9-10, 2024



Lower Weight MVP

Slava Shahbazyan
Chaminade
144 Pounds

Upper Weight MVP

Arvin Khosravy
Chaminade
157 Pounds

Placers

106 Pounds		
1st	Xavier Manzo	Canyon Springs
2nd	Benicio Thoms	Bishop Amat
3rd	Devia Shaposhnick	Great Oak
4th	Devin Tait	Temescal Canyon
5th	Leland Hodges	Indio
6th	Anthony Martinez	Lakeaide
7th	Patrick Loffard	Chaparral
8th	Shawn Conant	Sierra Vista

113 Pounds		
1st	Max Murillo	Canyon Springs
2nd	Benji Ruiz	Paloma Valley
3rd	Steven Corona	Vista Murrieta
4th	Braxden O'Brien	Temescal Canyon
5th	Soren Harris-Pham	JW North
6th	Tate Lowry	Redondo Union
7th	Jacob Jenner	Wilson Long Beach
8th	Vito Gomez	Indio

120 Pounds		
1st	Syruse Flores	Paloma Valley
2nd	Yousef Jubrall	Chaminade
3rd	Chase Carrasco	Lakeaide
4th	Brandon Ryan	Murrieta Valley
5th	Isaac Castaneda	Canyon Springs
6th	Jalden Webb	Great Oak
7th	Jacob Castillo	Cabrillo Long Beach
8th	Teagan McRae	Mira Costa

126 Pounds		
1st	David Fletes	Canyon Springs
2nd	Erik Quintero	Lakeaide
3rd	Nathan Itchon	Long Beach Poly
4th	Carson Gonzalez	Murrieta Valley
5th	Griffin Hettlinga	AB Millier
6th	Stacy Brown	Paloma Valley
7th	Sid Barron	JW North
8th	Daniel Campos	Indio

132 Pounds		
1st	Richard Murillo	Canyon Springs
2nd	Michael Kase	Chaminade
3rd	Kayden Java	Vista Murrieta
4th	Shawn Worley	Great Oak
5th	Ty Greer	Murrieta Valley
6th	Jake Barnes	Paloma Valley
7th	Ell Roripaugh	Chaparral
8th	Jason Fiala	Millikan

138 Pounds		
1st	Axel Esparza	Lakeaide
2nd	Gianluca Munoz	Bishop Amat
3rd	Jose Jimenez	Paloma Valley
4th	Caleb Penagos	Murrieta Mesa
5th	Nolan Himeifarb	Chaminade
6th	Jayden Ekong	Long Beach Poly
7th	Isalah Rivera	Millikan
8th	Angel Vargas	JW North

144 Pounds		
1st	Slava Shahbazyan	Chaminade
2nd	Marvin Morton	Temecula Valley
3rd	Brandon Owen	Paloma Valley
4th	Alek Carerra	Long Beach Poly
5th	Ryan Hanson	Murrieta Valley
6th	Anthony Vera	Wilson Long Beach
7th	Edward Gutierrez	Heritage
8th	Matthew Rivas	Lakeaide

150 Pounds		
1st	Gabriel Lemos	Temecula Valley
2nd	Issac Rea	Lakeaide
3rd	Chris Anguiano	Millikan
4th	Israel Dunn	Canyon Springs
5th	Travlon Jones	Chaparral
6th	Cutter East	Harvard-Westlake
7th	Evan Orozco	Murrieta Mesa
8th	James Alfaro	Murrieta Valley

157 Pounds		
1st	Arvin Khosravy	Chaminade
2nd	Alastar McRae	Mira Costa
3rd	Isalah Rea	Lakeaide
4th	Richard Trujillo	Canyon Springs
5th	Ivan Natcall	Chaparral
6th	Bobby Hernandez	Great Oak
7th	Andrew Hollenback	Lakewood
8th	Dylan Graff	Harvard-Westlake

165 Pounds		
1st	Kameron Phillips	Temecula Valley
2nd	Javon Major	Paloma Valley
3rd	Trey Culwell	Millikan
4th	Gavin Vargas	Canyon Springs
5th	Luke Desando	Great Oak
6th	Zach Evans	Crespi
7th	Efoesa Osayande	Peninsula
8th	Ethan Barrett	Murrieta Valley

175 Pounds		
1st	Primo Catalano	Chaminade
2nd	Ashton Lessig	Temecula Valley
3rd	Ryan Kaven	Millikan
4th	Daniel Mendoza	Hemet
5th	Dylan Natcoll	Chaparral
6th	Jacob Arellano	JW North
7th	Travis Coleman	Paloma Valley
8th	Kevin Hernandez	Elsinore

190 Pounds		
1st	Sonny Kling	Canyon Springs
2nd	Noah Watkins	Temecula Valley
3rd	Wyatt Toth	Great Oak
4th	Nelson Ramirez	Lakewood
5th	Joel Pulido	Lakeaide
6th	Eduardo Reyes	Long Beach Poly
7th	Richie Munoz	Bishop Amat
8th	Lance Vitte	Murrieta Mesa

215 Pounds		
1st	Coby Merrill	JW North
2nd	Noah Bode	Vista Murrieta
3rd	Kevin Rodriguez	Chaminade
4th	Tanner Costello	Millikan
5th	Simon Flores	Paloma Valley
6th	Ifeanyi Onye	Murrieta Mesa
7th	Melohi Sipowicz	Hemet
8th	Molasa Laguna	Jurupa Valley

265 Pounds		
1st	Miguel Saldana	Indio
2nd	Justice ElSayed	Temecula Valley
3rd	Macon Olive	Santa Monica
4th	Kajul Costa	Elsinore
5th	Angel Mercado	Crespi
6th	Luke Kingman	Murrieta Valley
7th	Tyler Gaines	Long Beach Poly
8th	Damien Balbuena	Jordan

Team Score Final	
1	Canyon Springs 233.5
2	Paloma Valley 217.5
3	Chaminade 212.5
4	Temecula Valley 195
5	Lakeaide 159.5
6	Millikan 149
7	Great Oak 121.5
8	Murrieta Valley 119
9	Long Beach Poly 108
10	Bishop Amat 105
11	JW North 98.5
12	Chaparral 86.5
13	Indio 80
14	Vista Murrieta 78.5
15	Redondo Union 68.5
16	Murrieta Mesa 67
17	Temescal Canyon 62.5
18	Lakewood 61
19	Crespi 58
20	Mira Costa 58
21	Wilson Long Beach 57.5
22	Santa Monica 56
23	Hemet 50.5
24	Elsinore 46
25	Coachella Valley 44
26	Harvard-Westlake 36
27	Sierra Vista 31
28	Peninsula 27.5
29	Heritage 27
30	Jurupa Valley 27
31	Yucca Valley 27
32	Pacific 20
33	AB Millier 18
34	Rubidoux 18
35	Desert Mirage 17
36	Alemny 16
37	Desert Hot Springs 16
38	Beverly Hills 15.5
39	Webb 15
40	Indian Springs 14
41	Jordan 12
42	Cabrillo Long Beach 11
43	Riverdale Poly 11
44	Workman 9
45	Compton 7
46	Nogales 6
47	Cathedral City 5
48	Duarte 2

EIF SS Boys Individuals Southern Div

EIF Qualifier 106

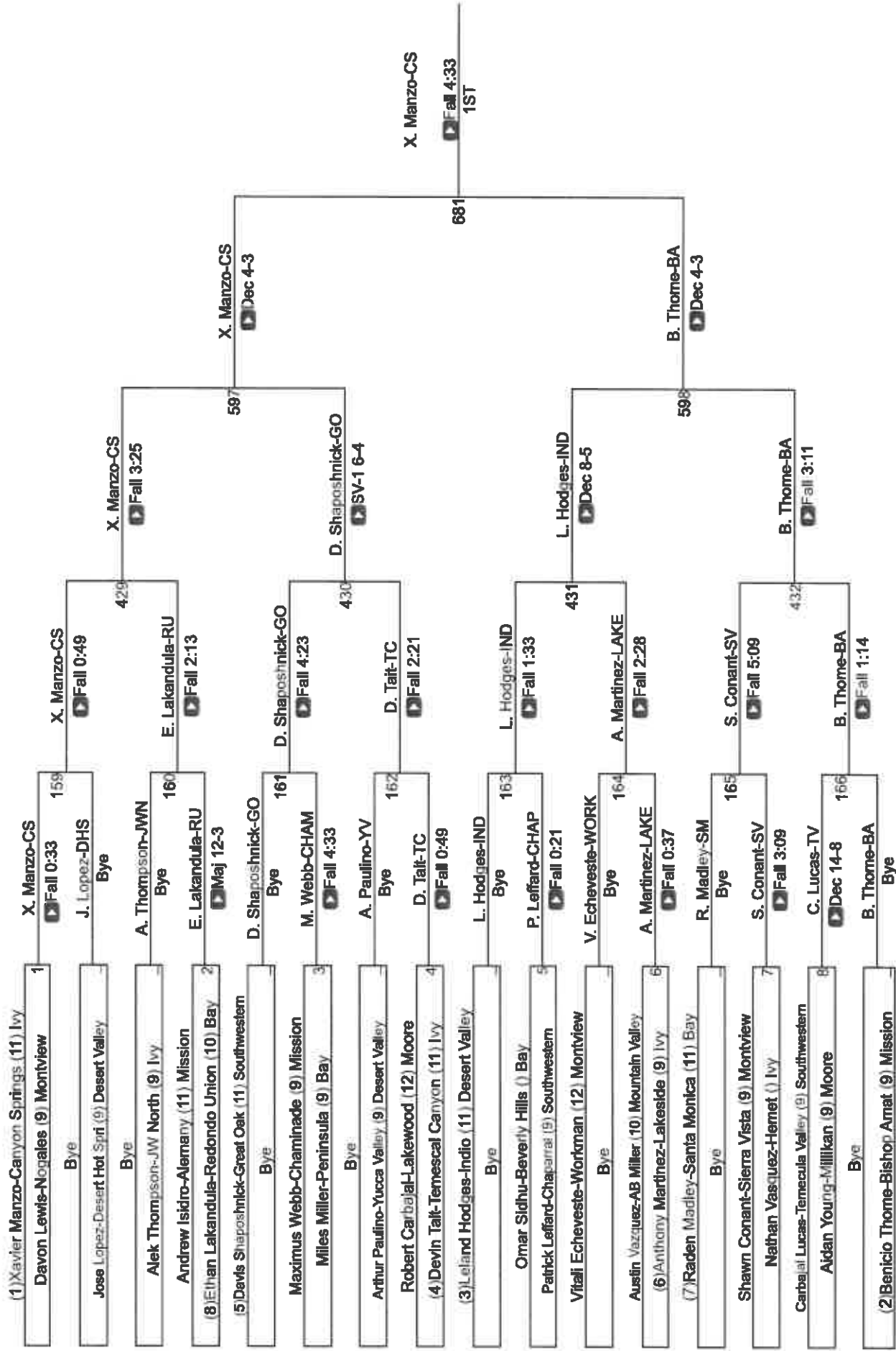

CIF Qualifier 106

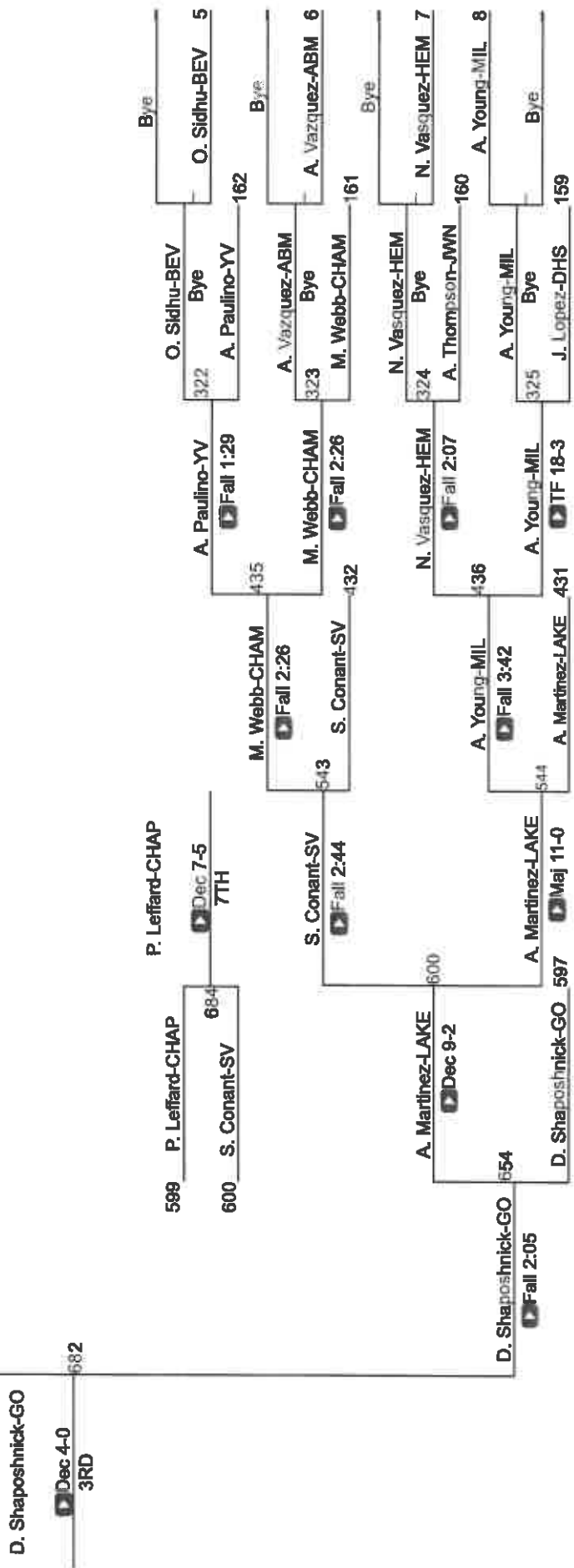
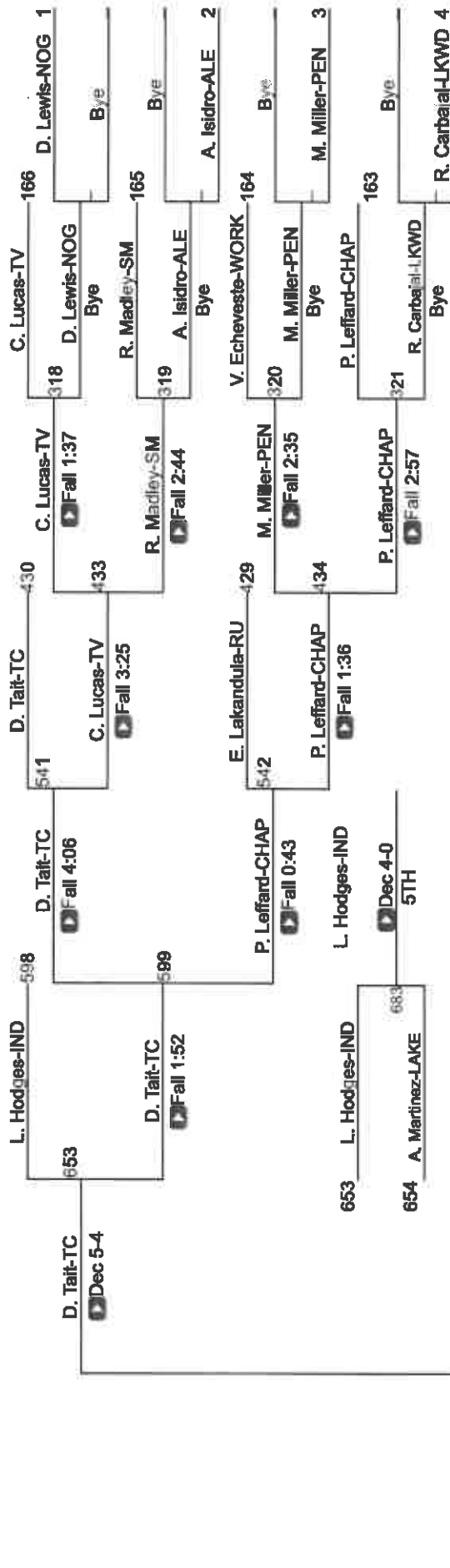

EIF SS Boys Individuals Southern Div

EIF Qualifier 113

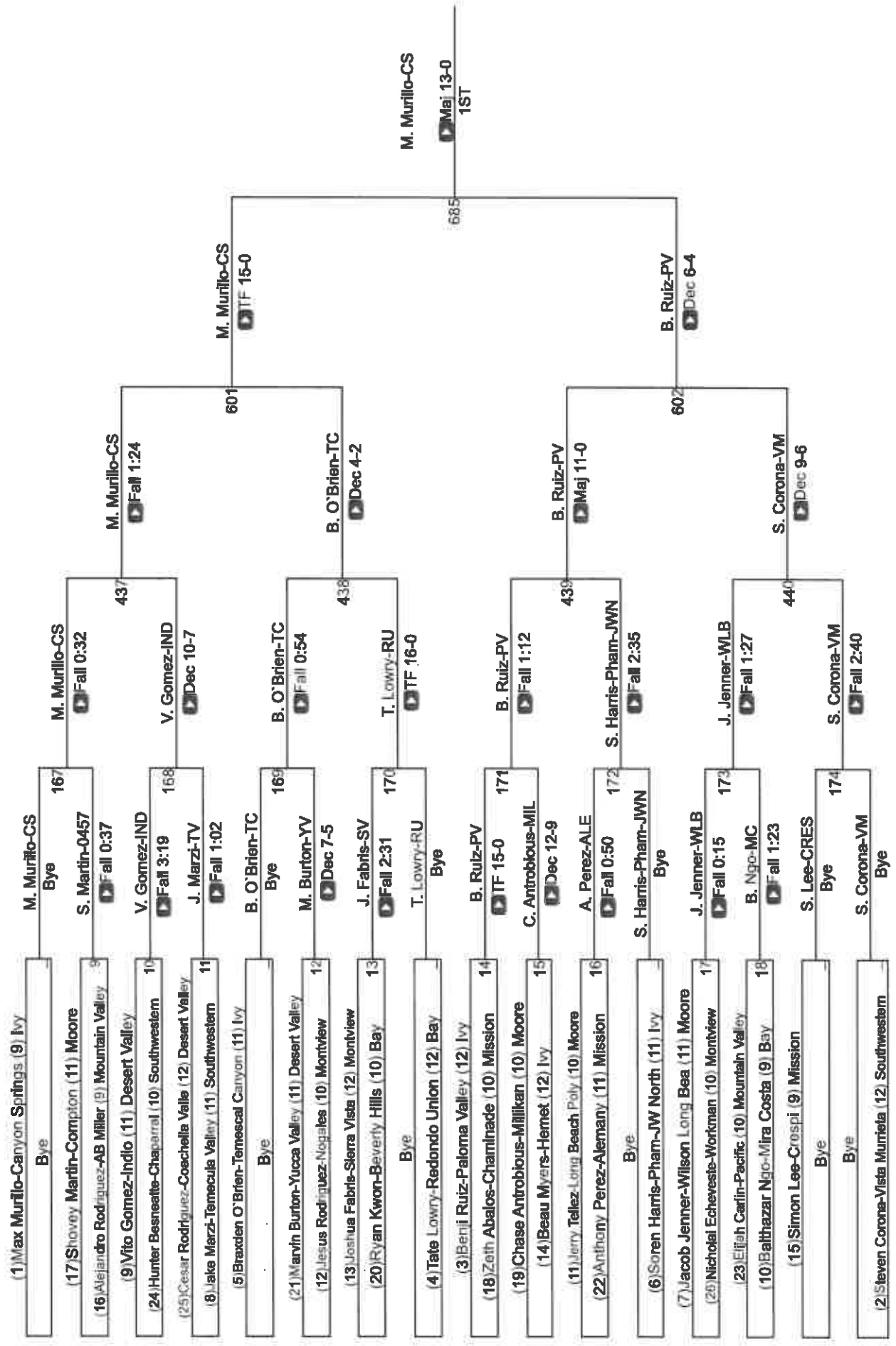

CIF Qualifier 113

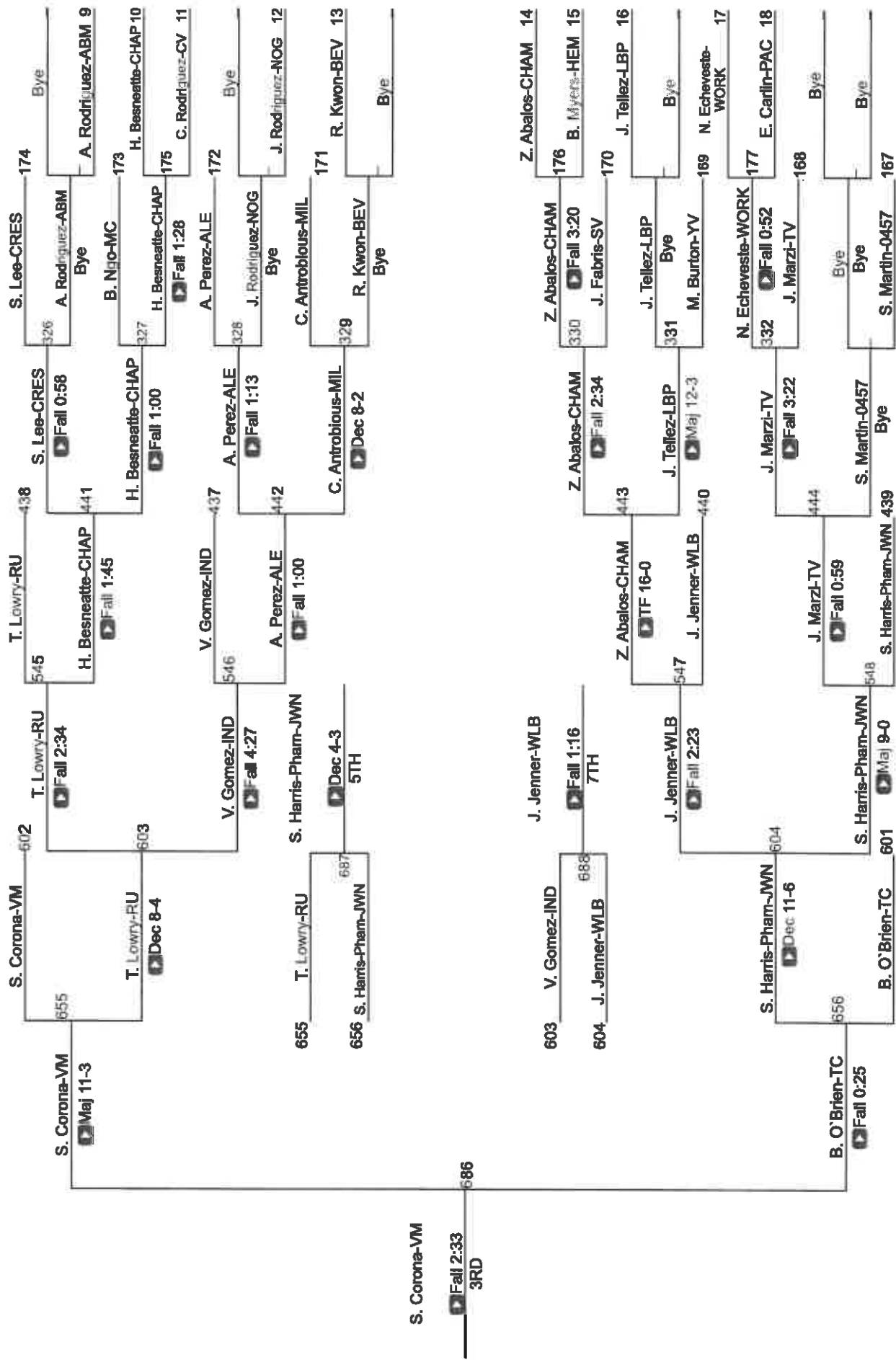

GIF SS Boys Individuals Southern Div

GIF Qualifier 120

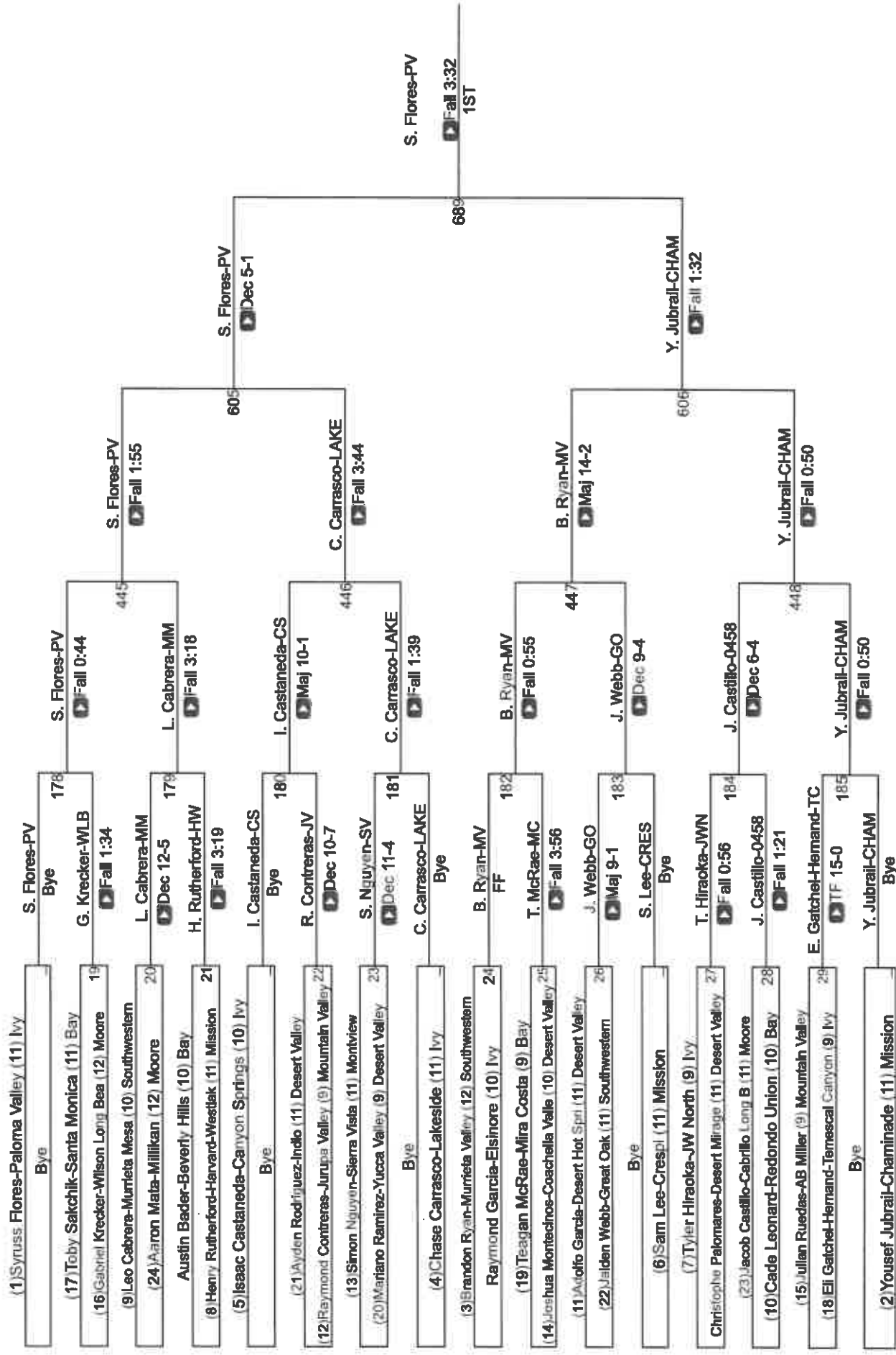

EIF SS Boys Individuals Southern Div

EIF Qualifier 126

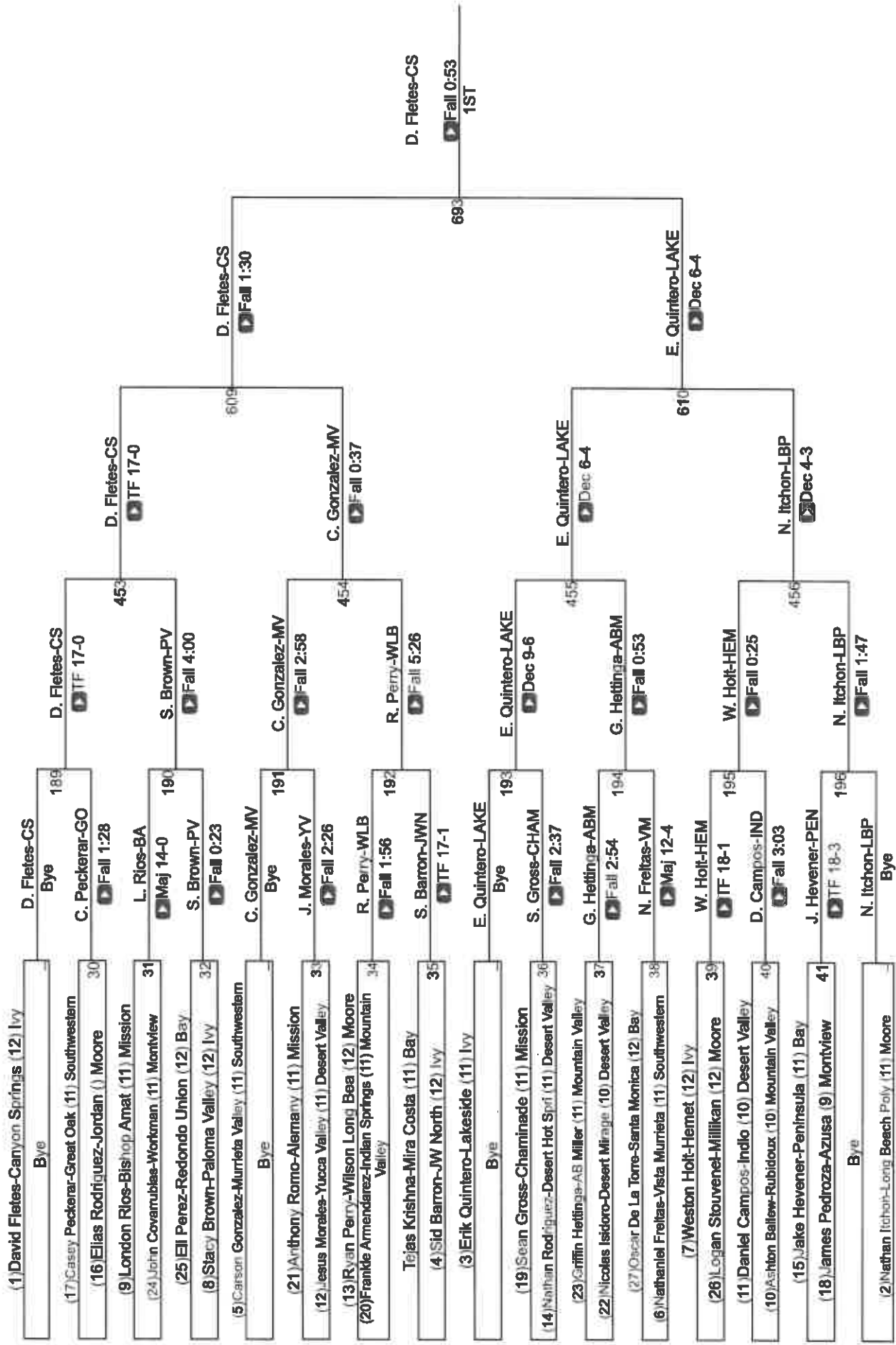

EIF Qualifier 126

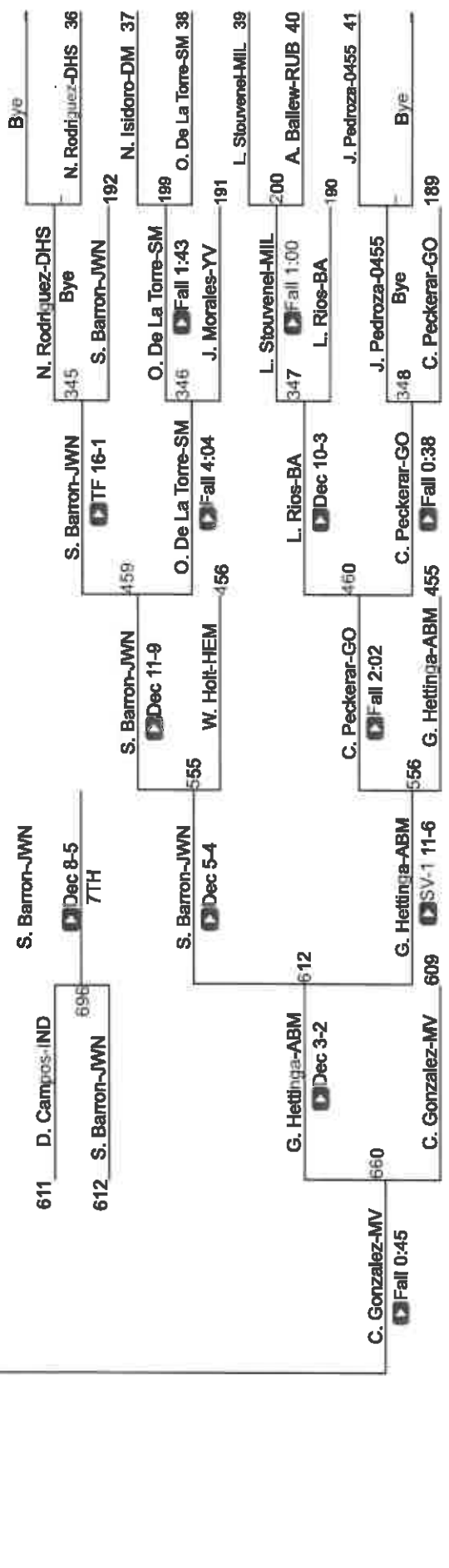
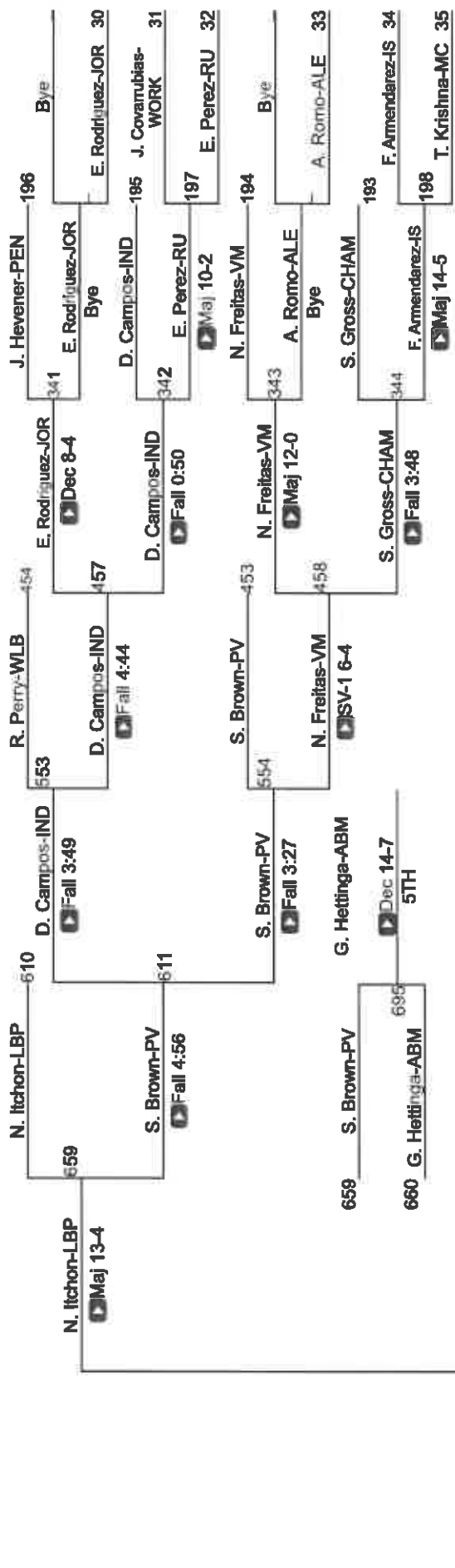

EIF SS Boys Individuals Southern Div

EIF Qualifier 132

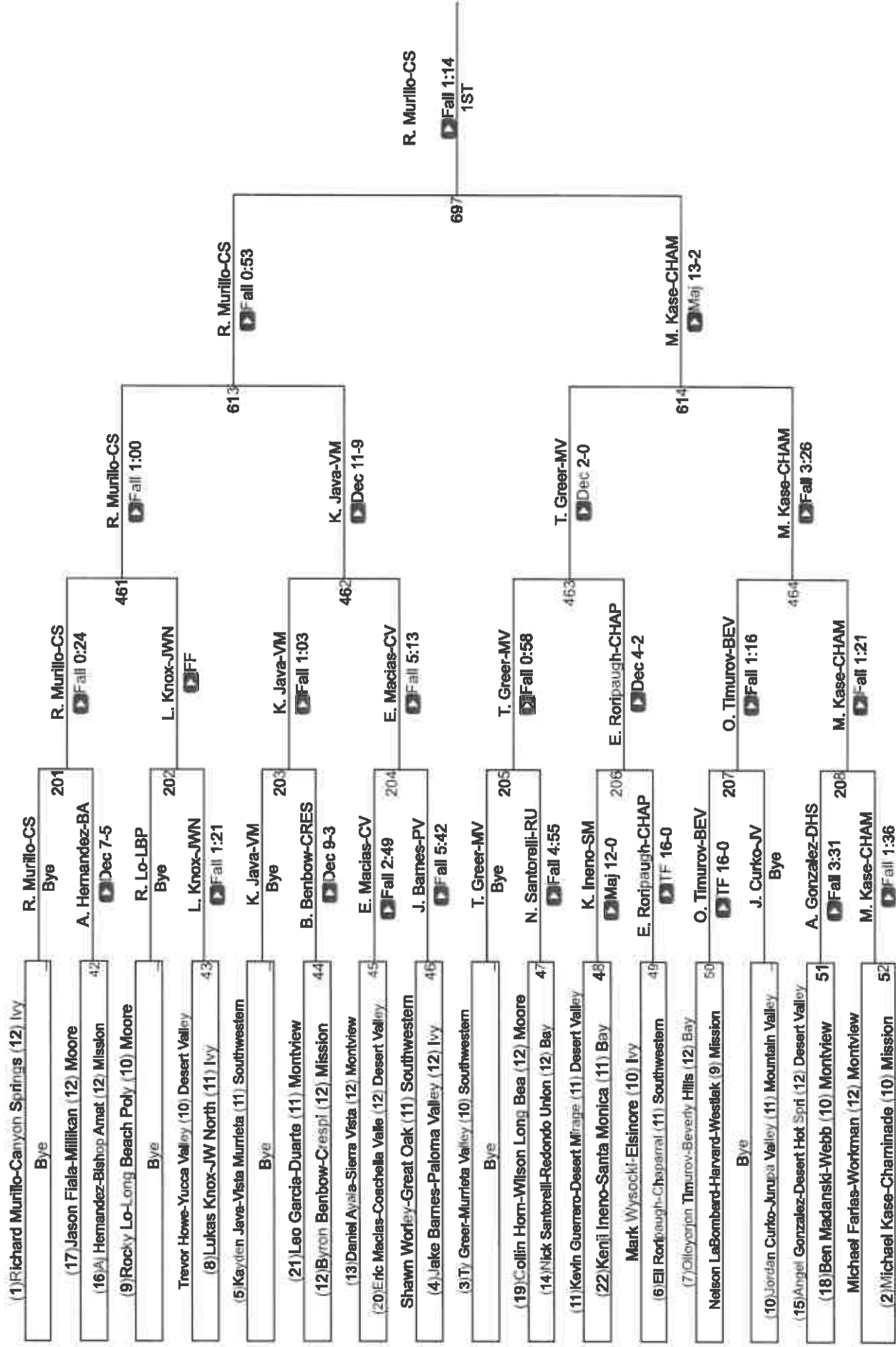

CIF Qualifier 132

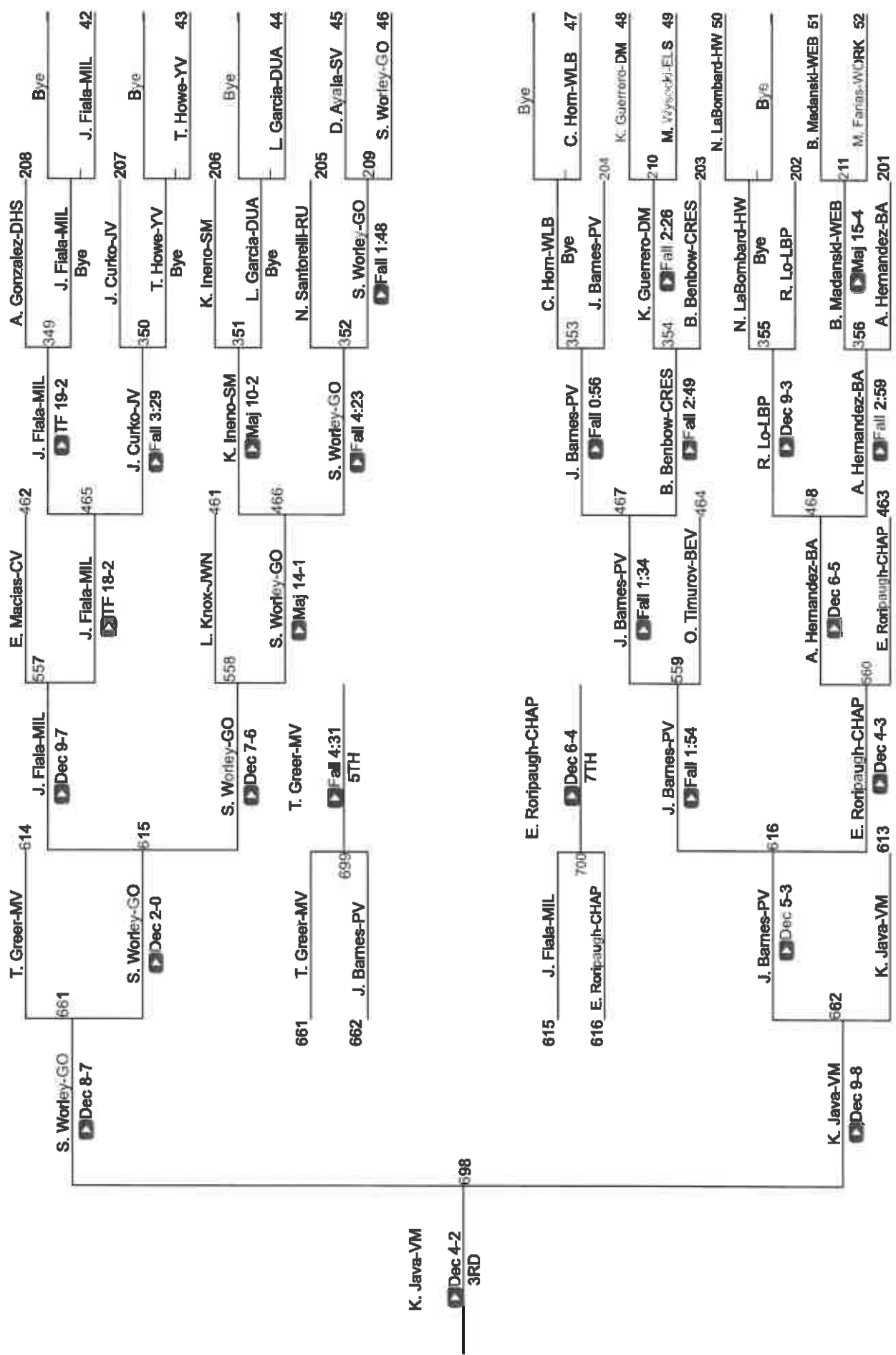

CIF SS Boys Individuals Southern Div

CIF Qualifier 138

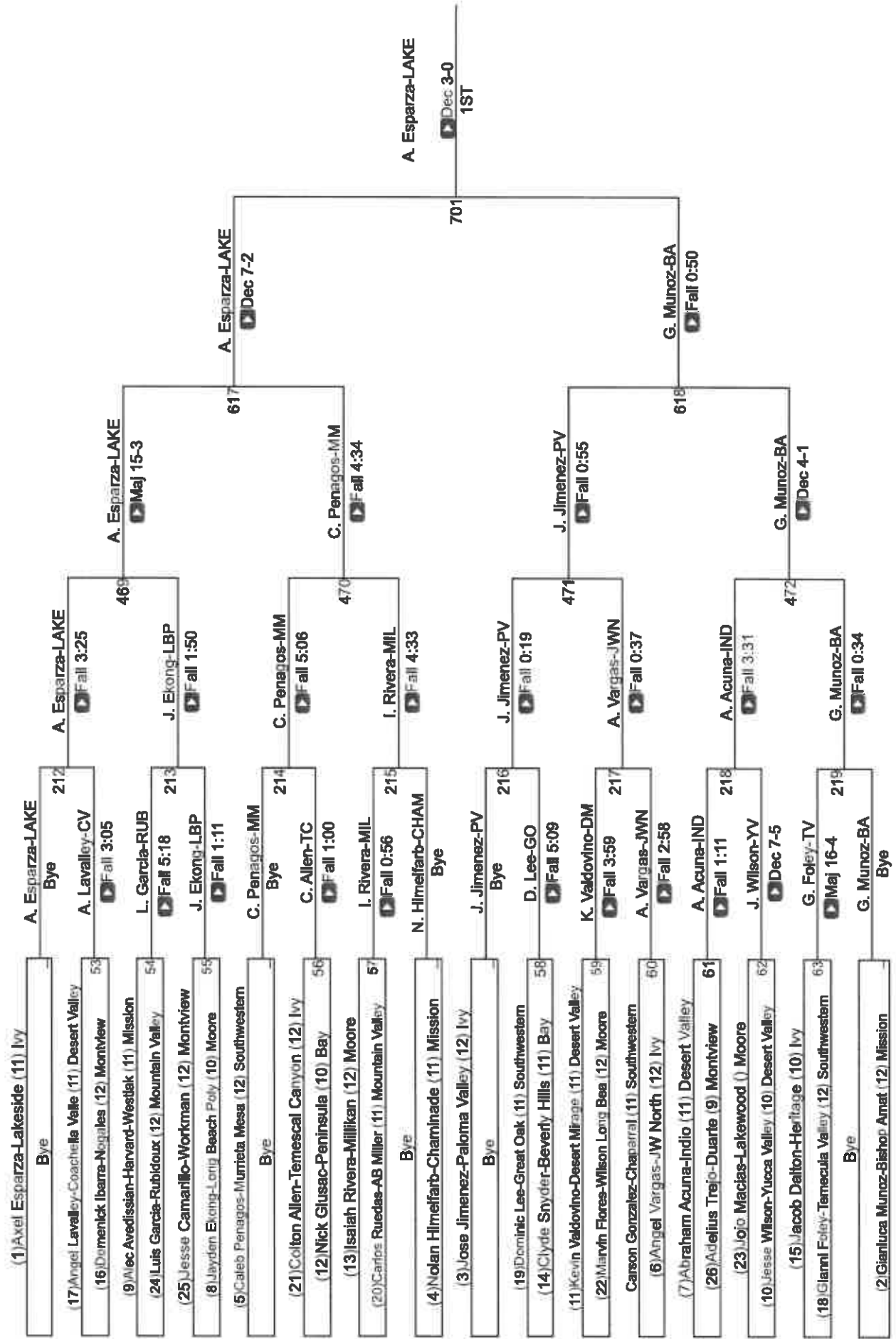

EIF Qualifier 138

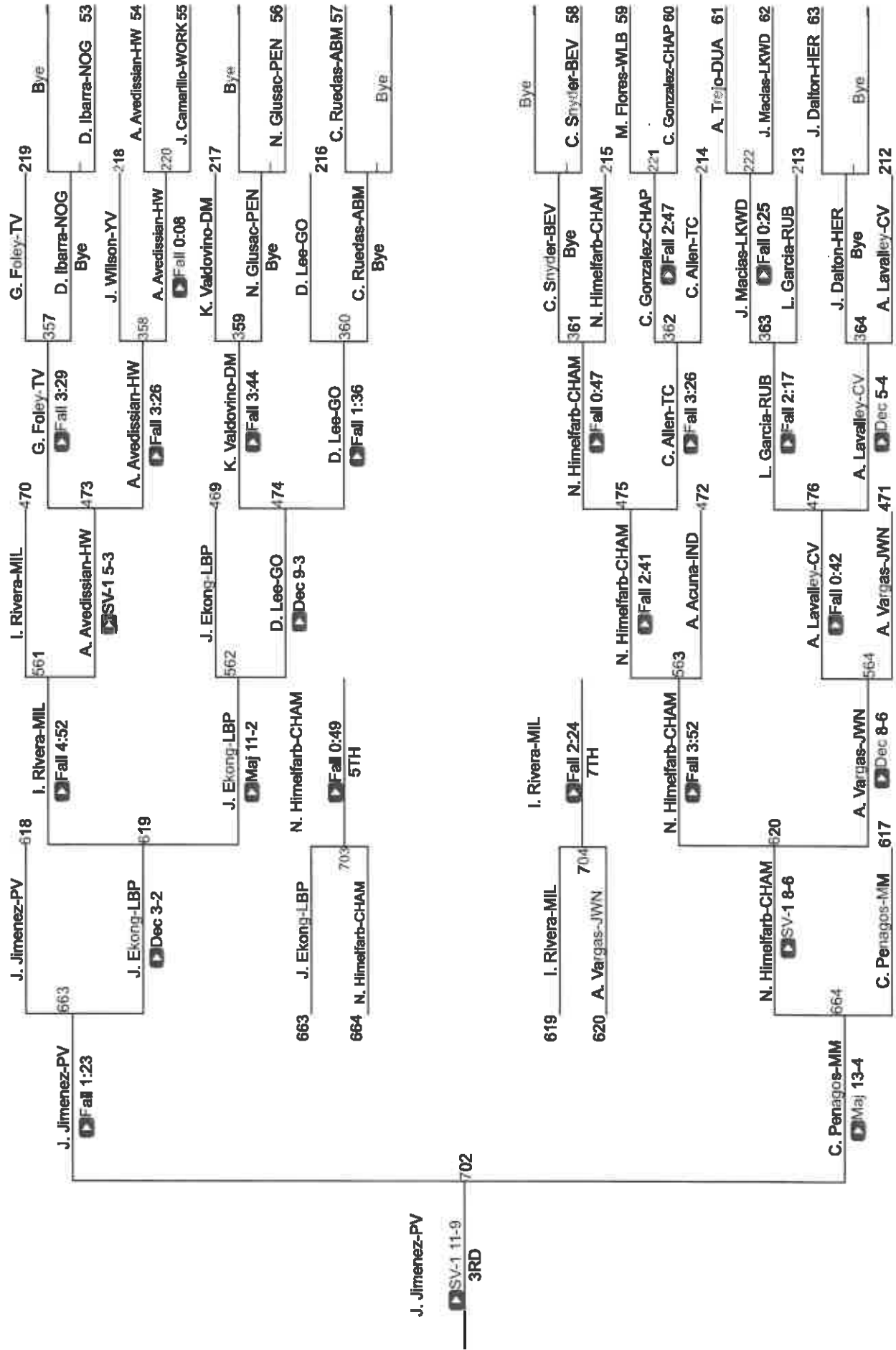

CIF SS Boys Individuals Southern Div

CIF Qualifier 144

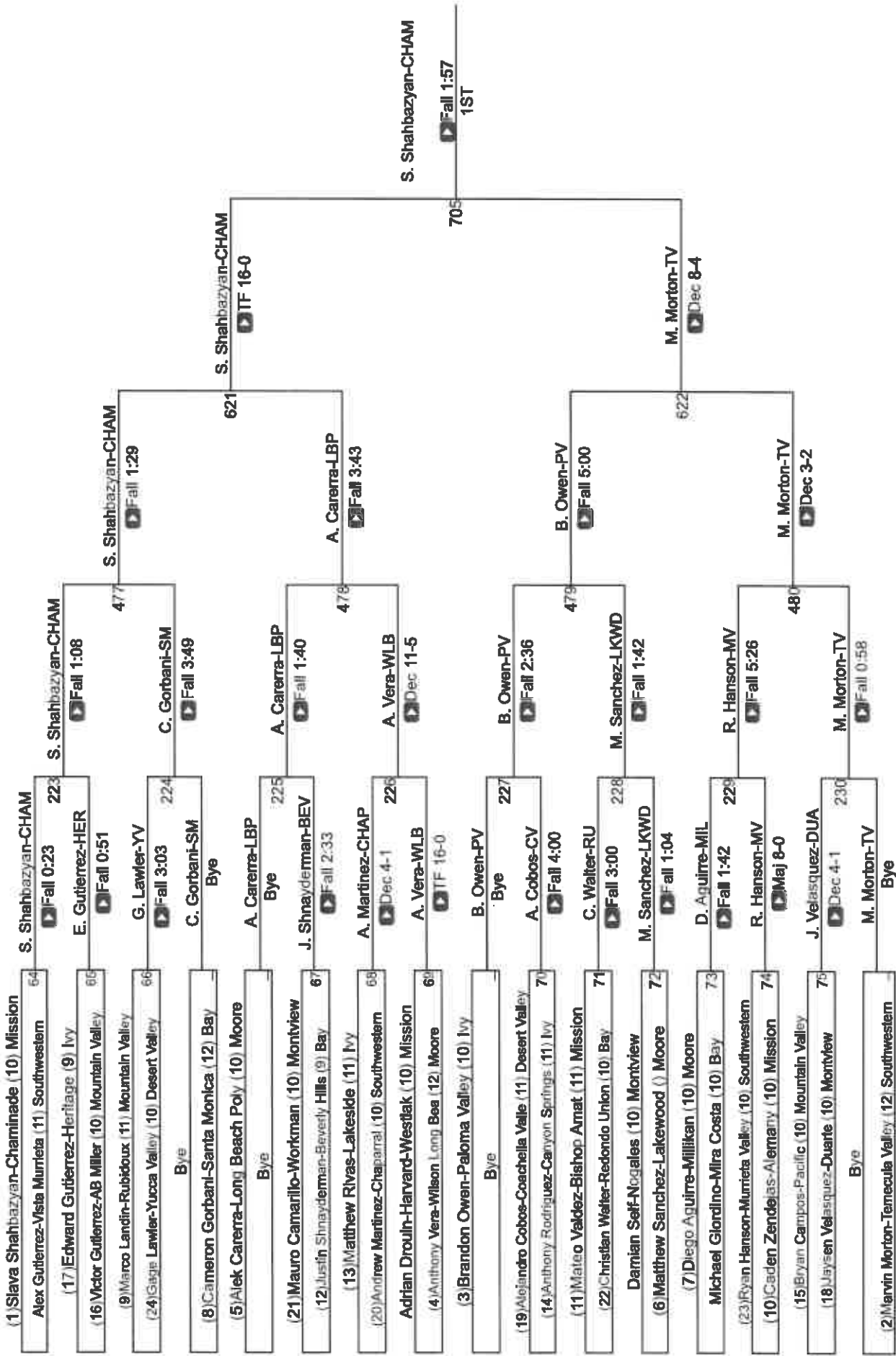

EIF Qualifier 144

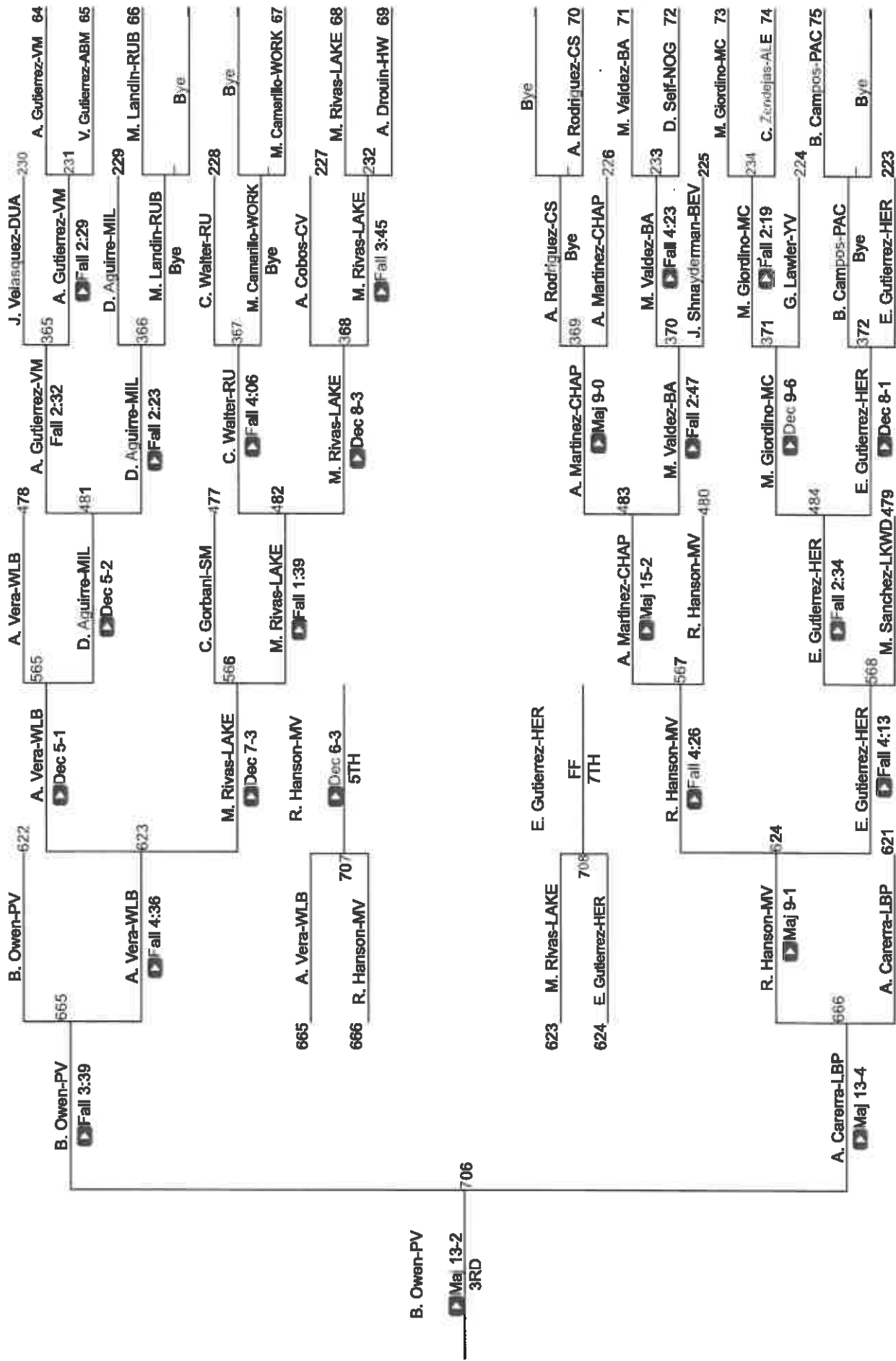

GIF SS Boys Individuals Southern Div

GIF Qualifier 150

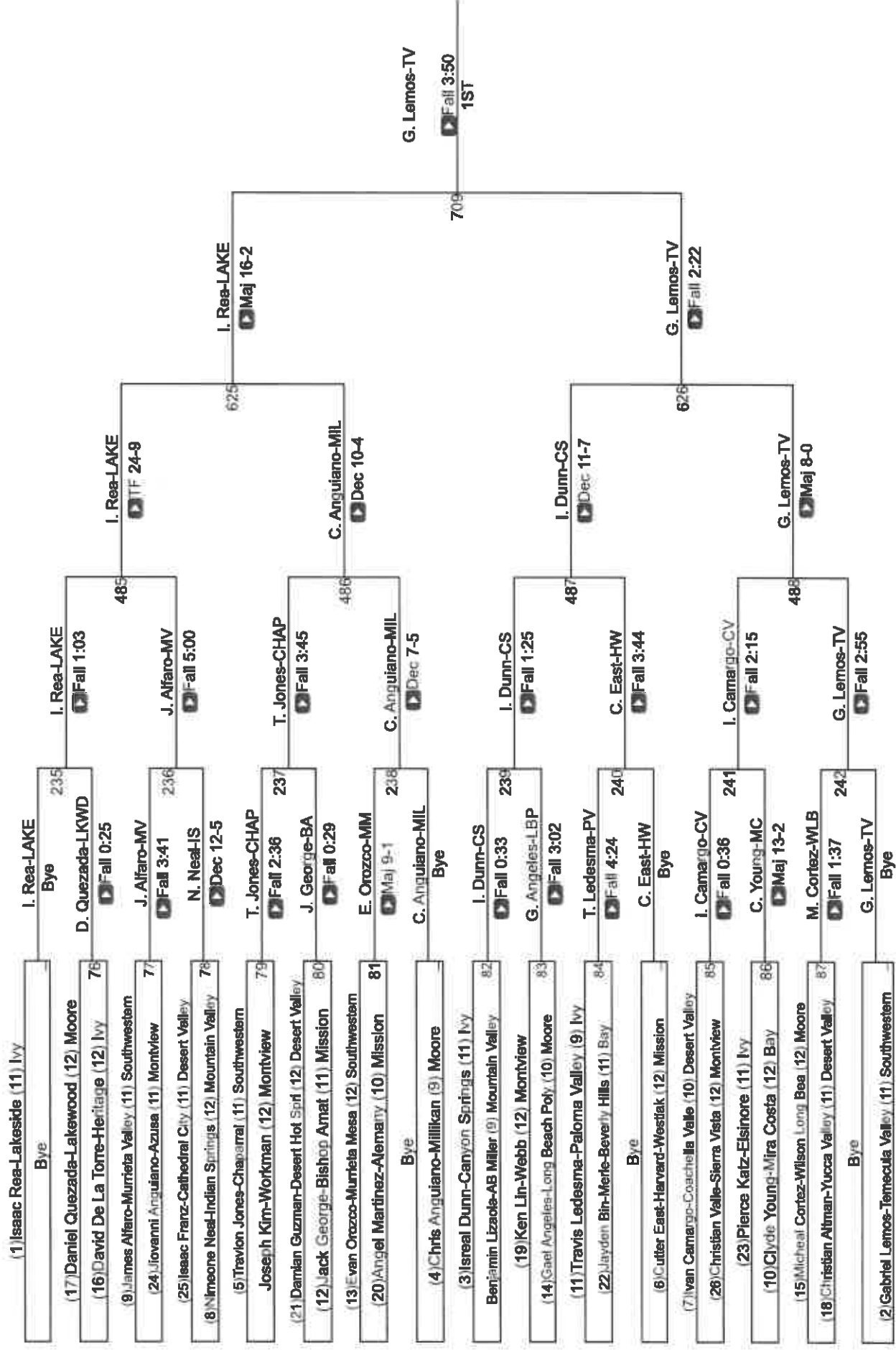

EIF Qualifier 150

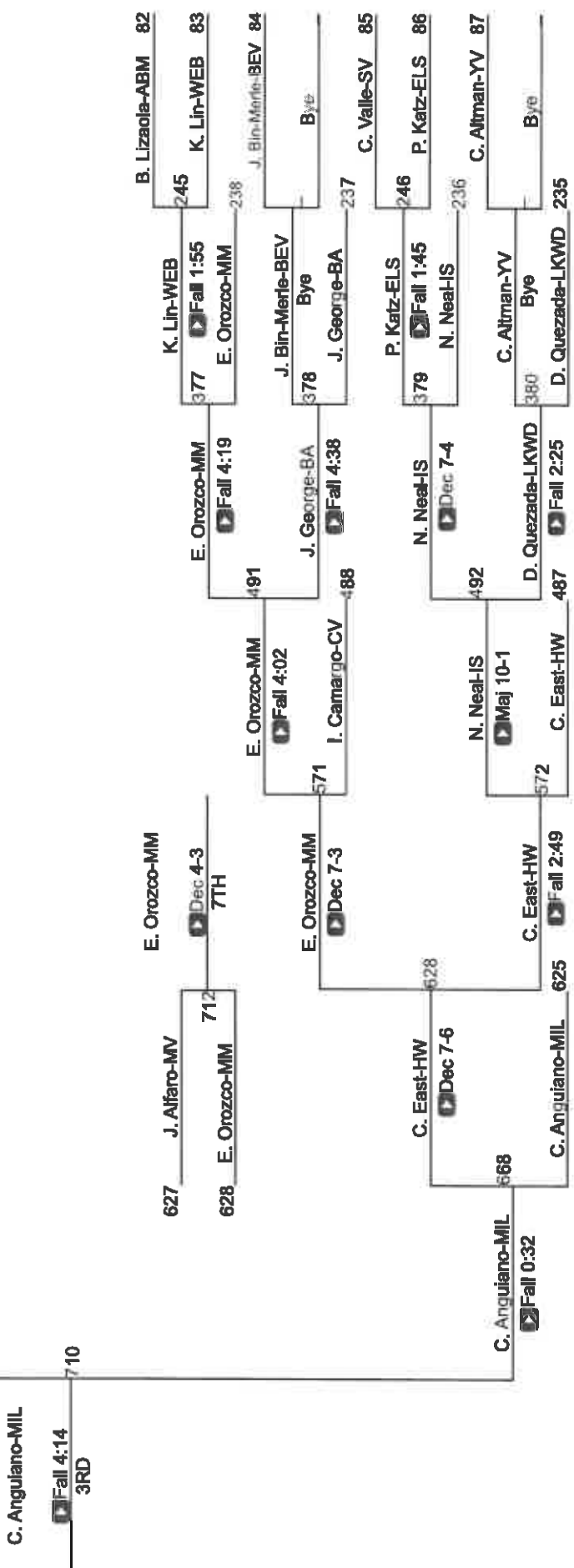
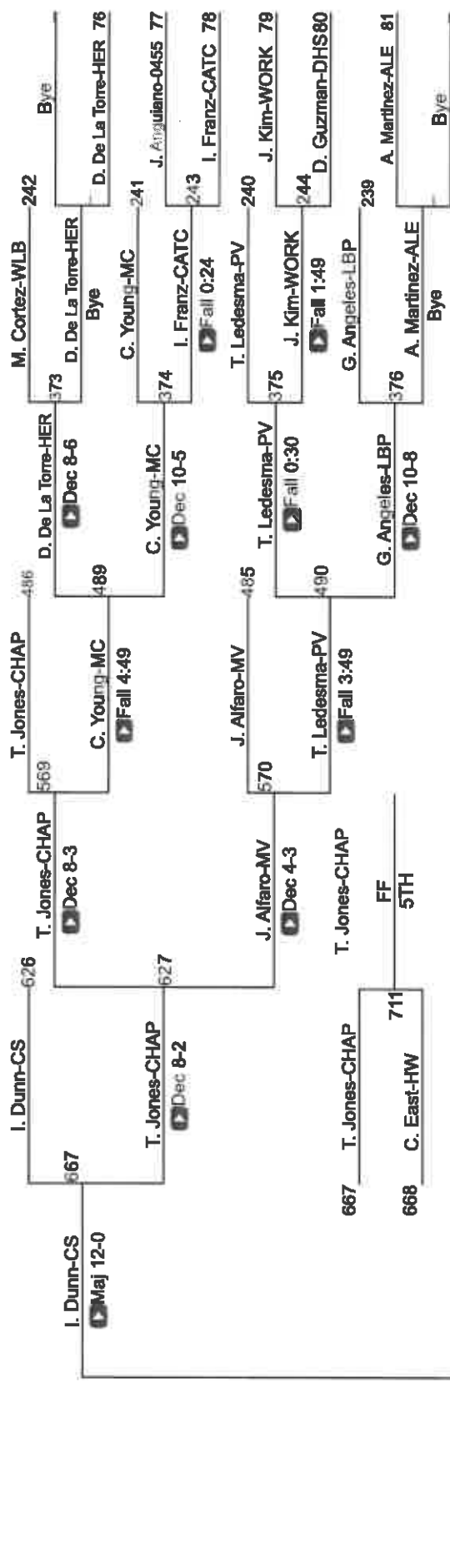

EIF SS Boys Individuals Southern Div

EIF Qualifier 157

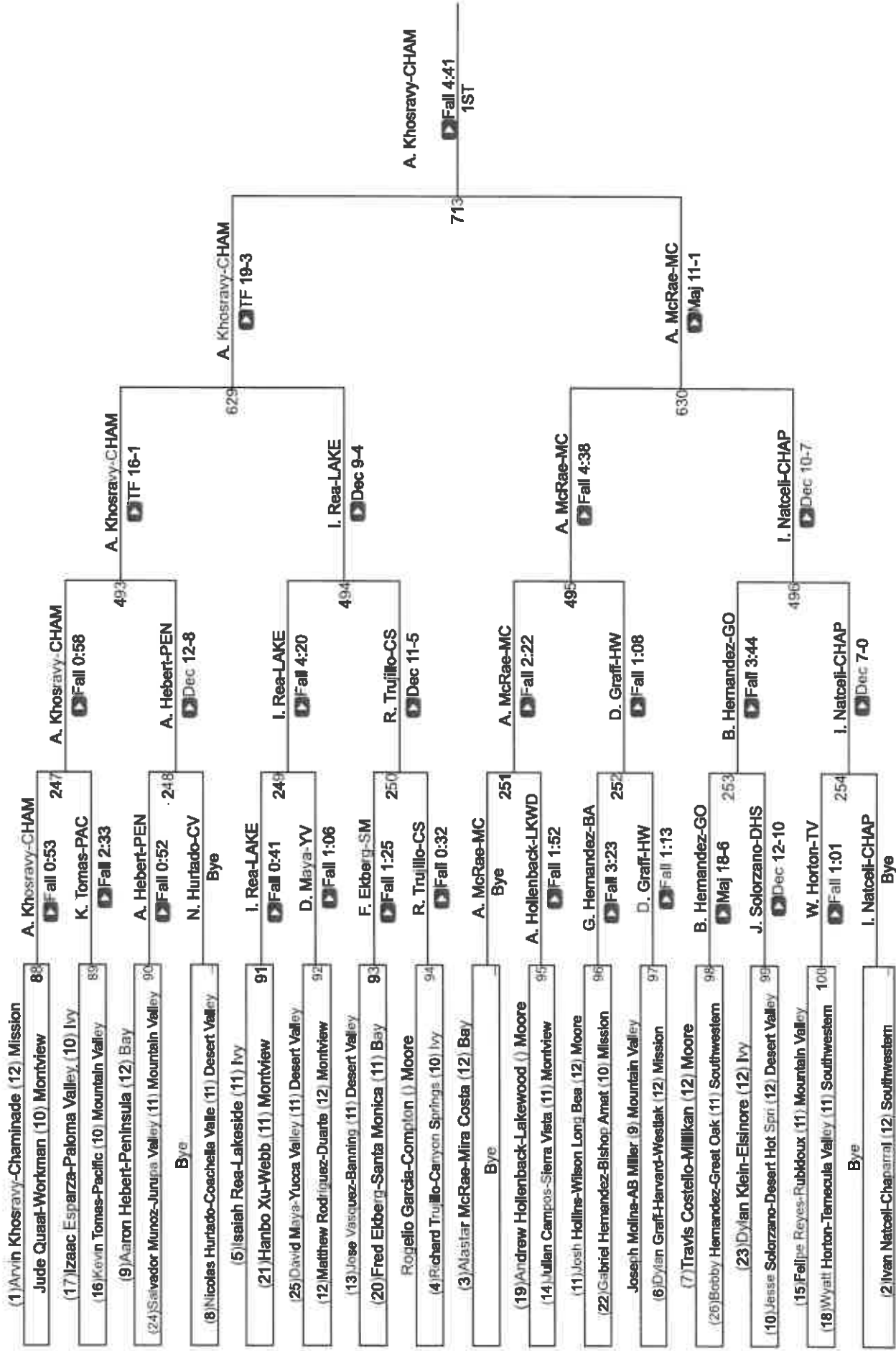

EIF Qualifier 157

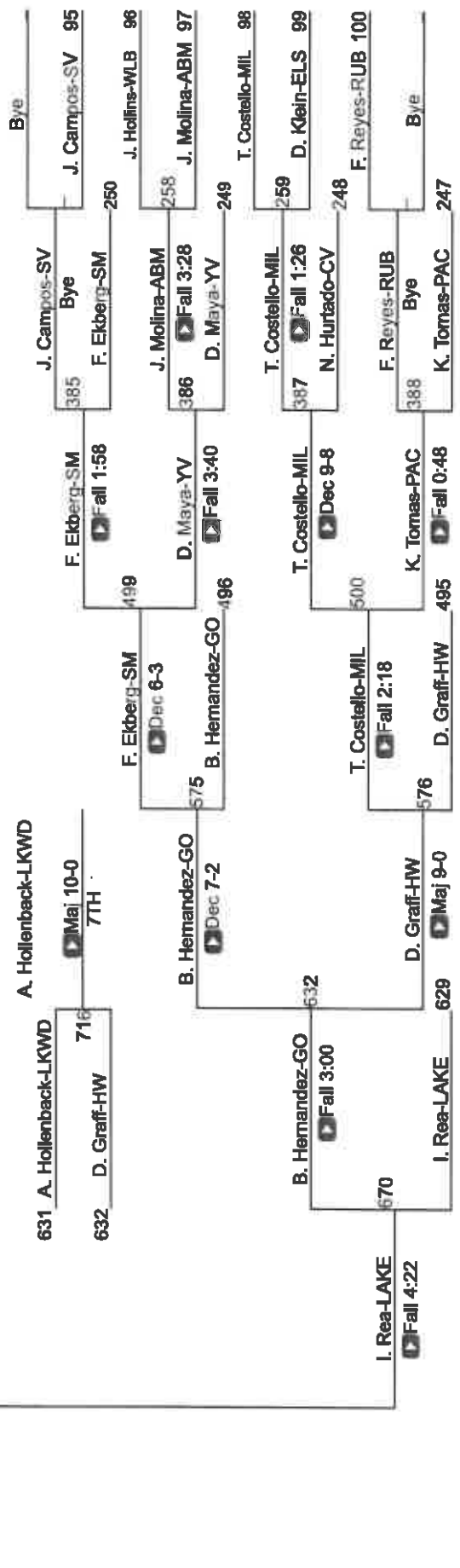
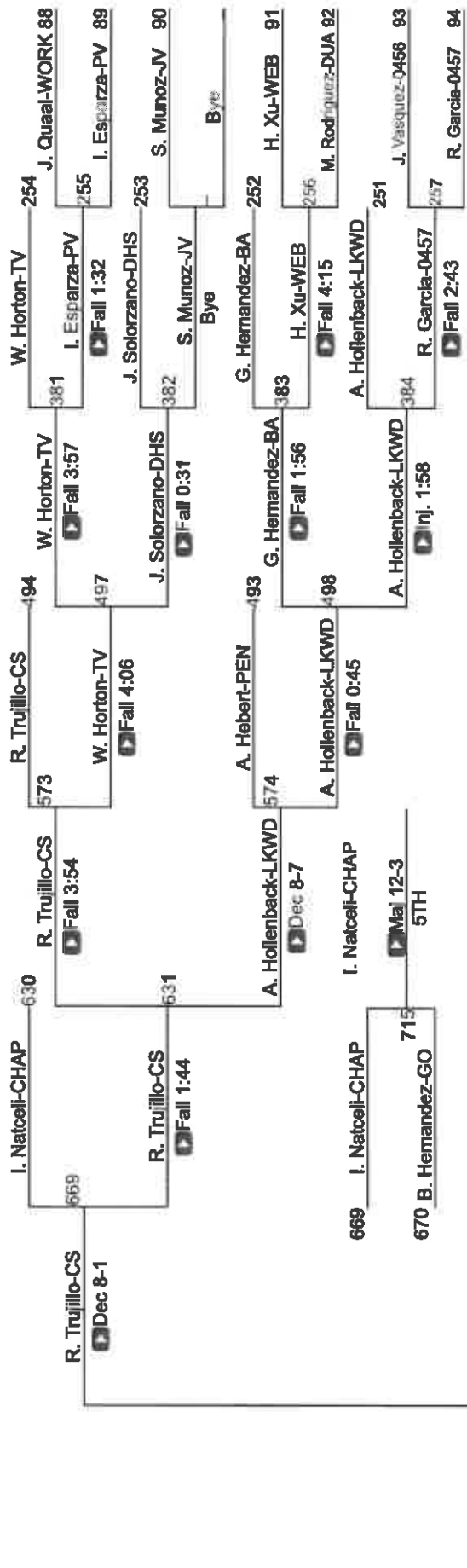

GIF SS Boys Individuals Southern Div

GIF Qualifier 165

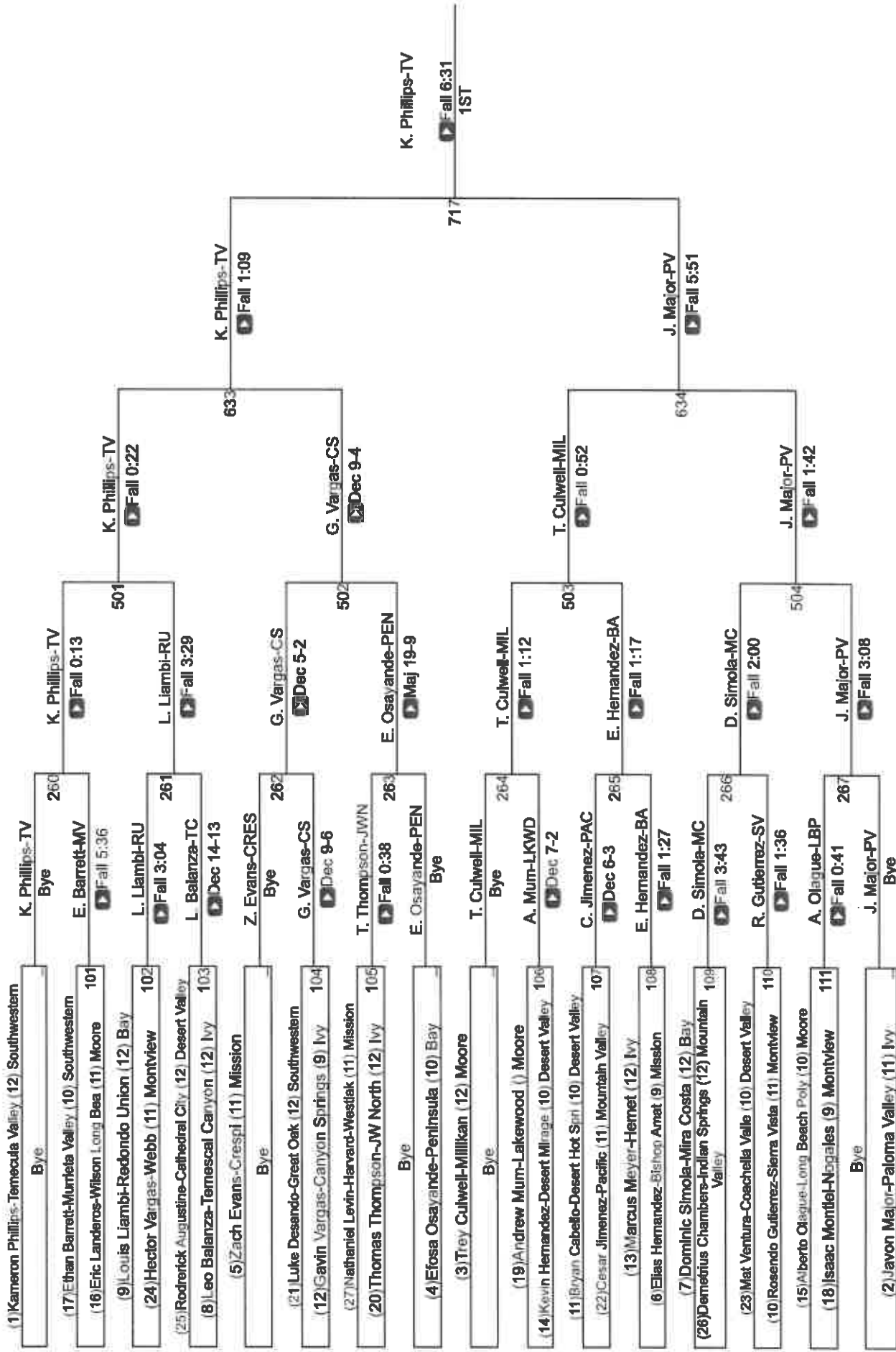

CIF Qualifier 165

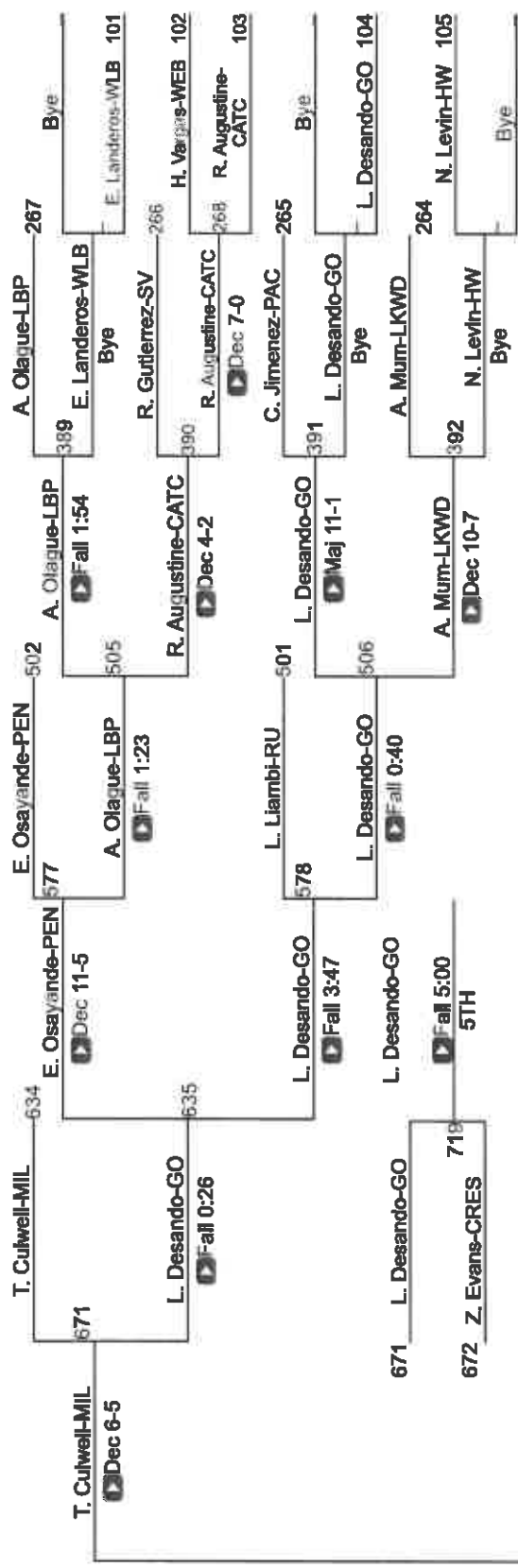

T. Cutwell-MIL

Fall 1:31
3RD

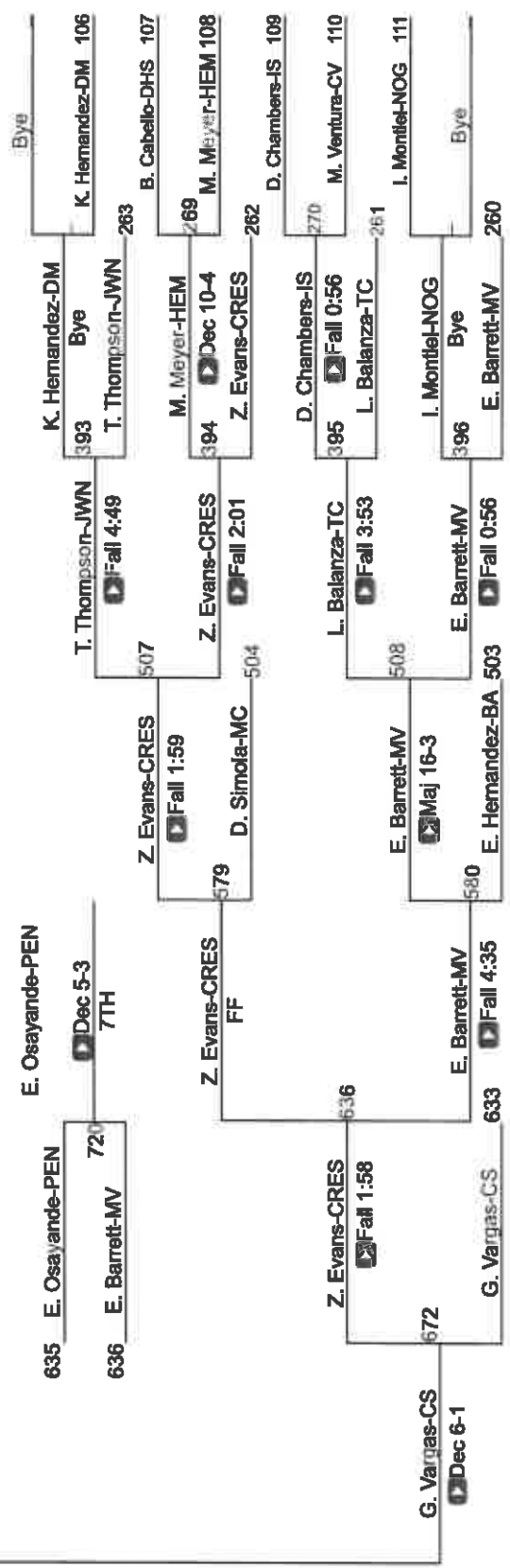

E. Osayande-PEN

Dec 5-3
7TH

635 E. Osayande-PEN
636 E. Barrett-MV

Z. Evans-CRES
FF

636 Z. Evans-CRES
Fall 1:58

672 G. Vargas-CS
Dec 6-1

E. Barrett-MV
Fall 4:35

633 G. Vargas-CS

CIF SS Boys Individuals Southern Div

CIF Qualifier 175

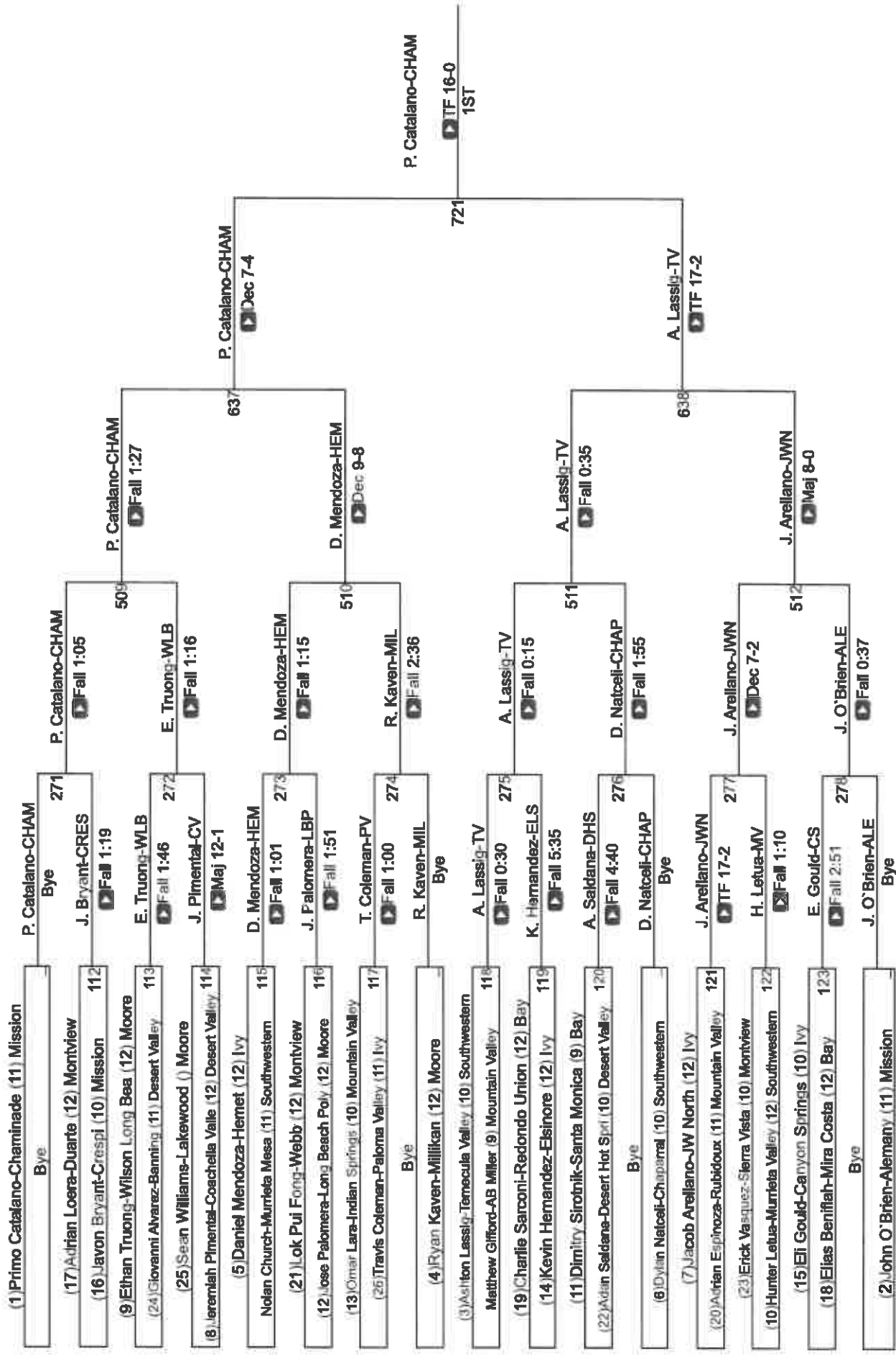

EIF Qualifier 175

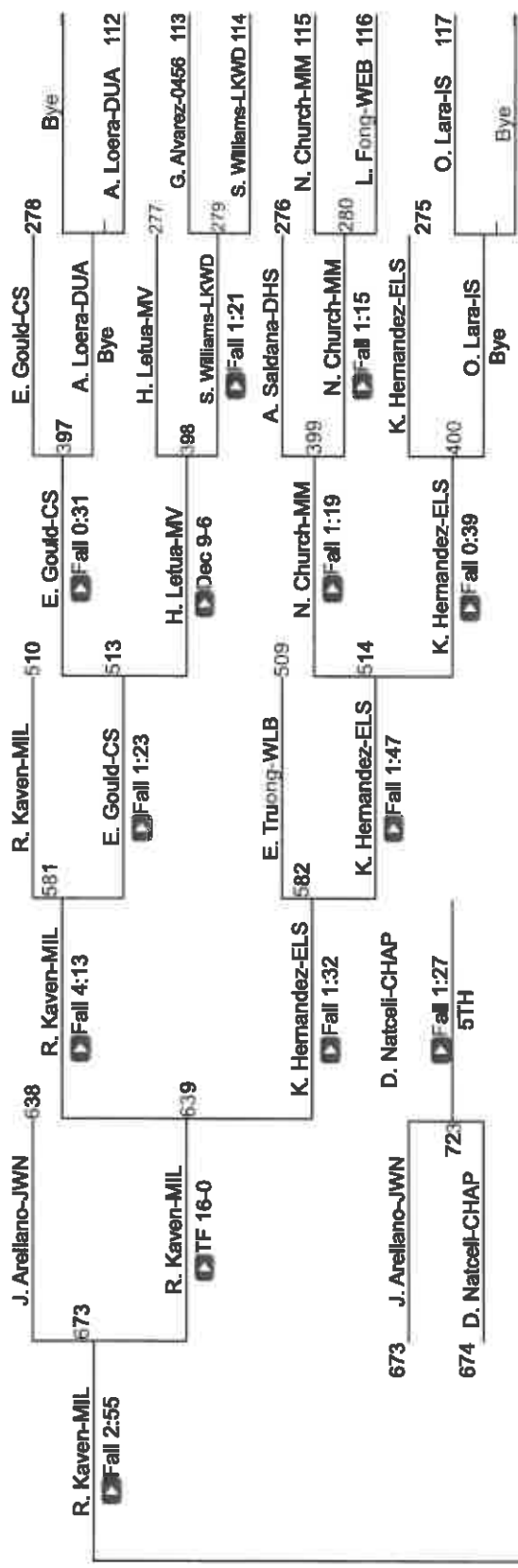

R. Kaven-MIL

Dec 10-4
3RD

722

GIF SS Boys Individuals Southern Div

GIF Qualifier 190

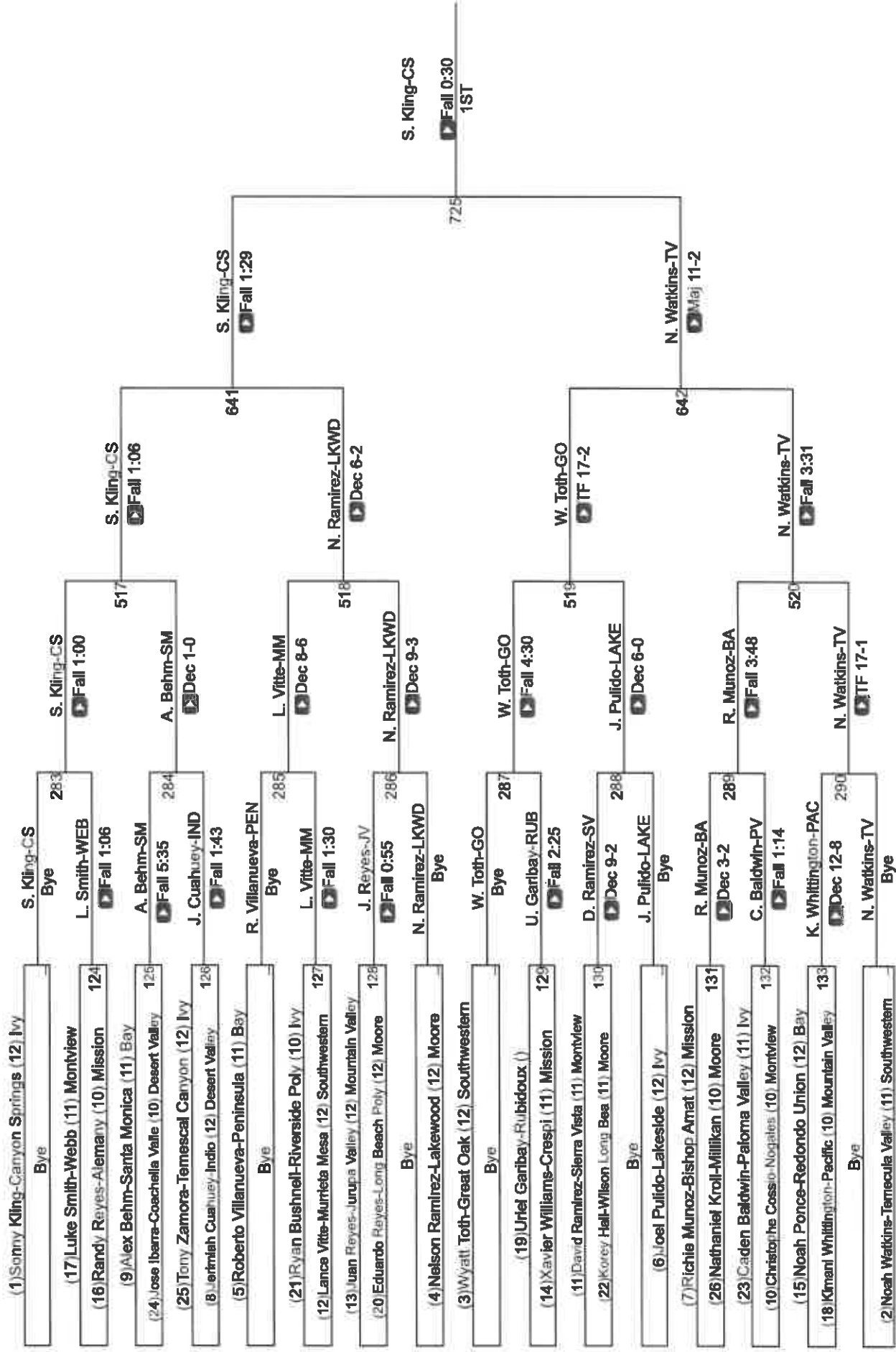

EIF Qualifier 190

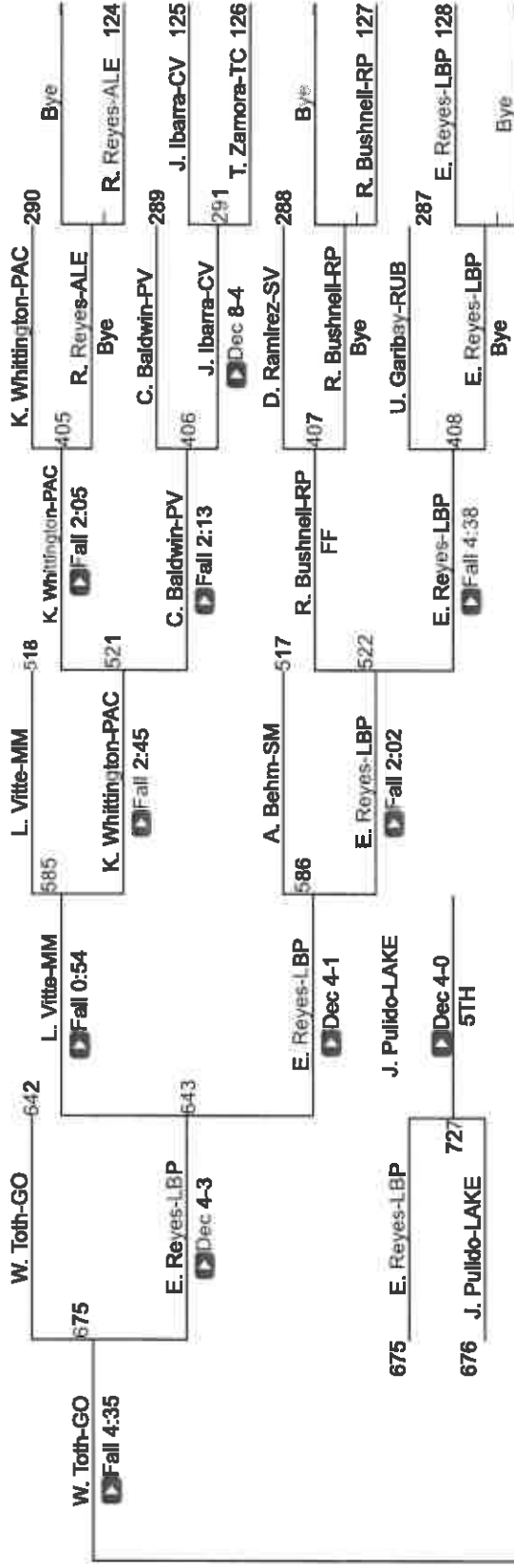

W. Toth-GO

Fall 3:44

3RD

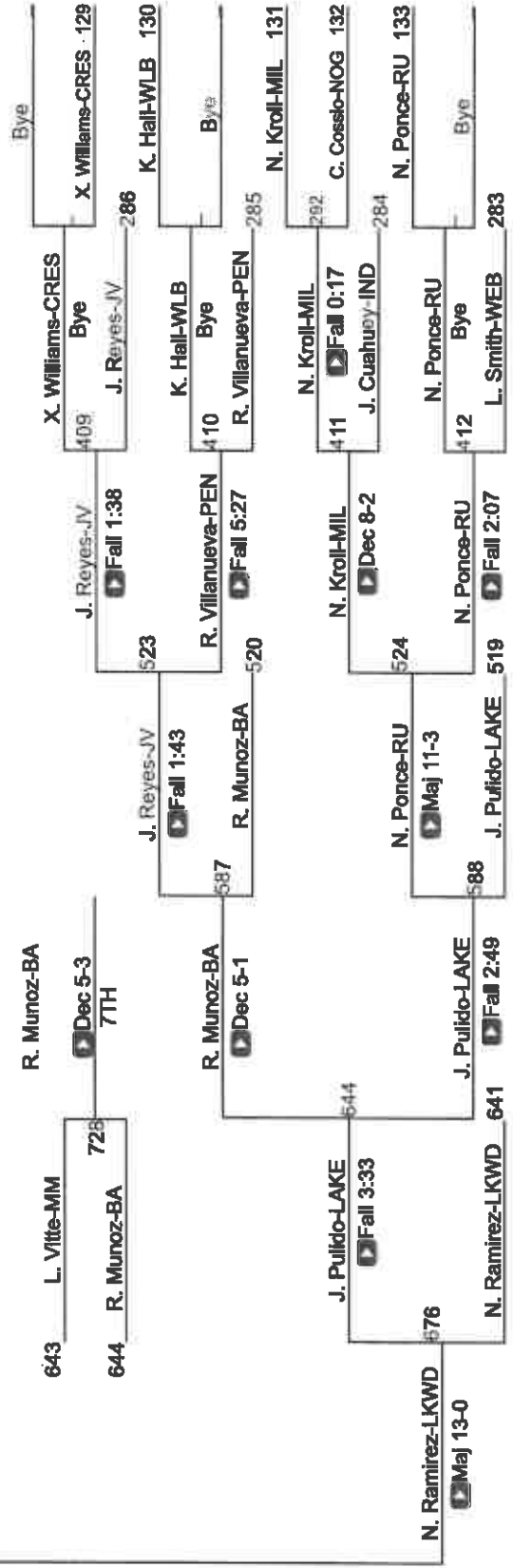

R. Munoz-BA

643 L. Vitte-MM

644 R. Munoz-BA

728

7TH

Dec 5-3

5TH

Dec 4-1

Dec 4-0

5TH

Dec 4-1

Dec 4-0

5TH

Dec 4-1

Dec 4-0

5TH

Dec 4-1

Dec 4-0

5TH

Dec 4-1

Dec 4-0

5TH

Dec 4-1

R. Munoz-BA

523

524

525

526

527

528

529

530

531

532

533

534

535

536

537

538

539

540

541

542

543

544

R. Munoz-BA

523

524

525

526

527

528

529

530

531

532

533

534

535

536

537

538

539

540

541

542

543

544

R. Munoz-BA

523

524

525

526

527

528

529

530

531

532

533

534

535

536

537

538

539

540

541

542

543

544

R. Munoz-BA

523

524

525

526

527

528

529

530

531

532

533

534

535

536

537

538

539

540

541

542

543

544

R. Munoz-BA

523

524

525

526

527

528

529

530

531

532

533

534

535

536

537

538

539

540

541

542

543

544

R. Munoz-BA

523

524

525

526

527

528

529

530

531

532

533

534

535

536

537

538

539

540

541

542

543

544

R. Munoz-BA

523

524

525

526

527

528

529

530

531

532

533

534

535

536

537

538

539

540

541

542

543

544

R. Munoz-BA

523

524

525

526

527

528

529

530

531

532

533

534

535

536

537

538

539

540

541

542

543

544

R. Munoz-BA

523

524

525

526

527

528

529

530

531

532

533

534

535

536

537

538

539

540

541

542

543

544

R. Munoz-BA

523

524

525

526

527

528

529

530

531

532

533

534

535

536

537

538

539

540

541

542

543

544

R. Munoz-BA

523

524

525

526

527

528

529

530

531

532

533

534

535

536

537

538

539

540

541

542

EIF SS Boys Individuals Southern Div

EIF Qualifier 215

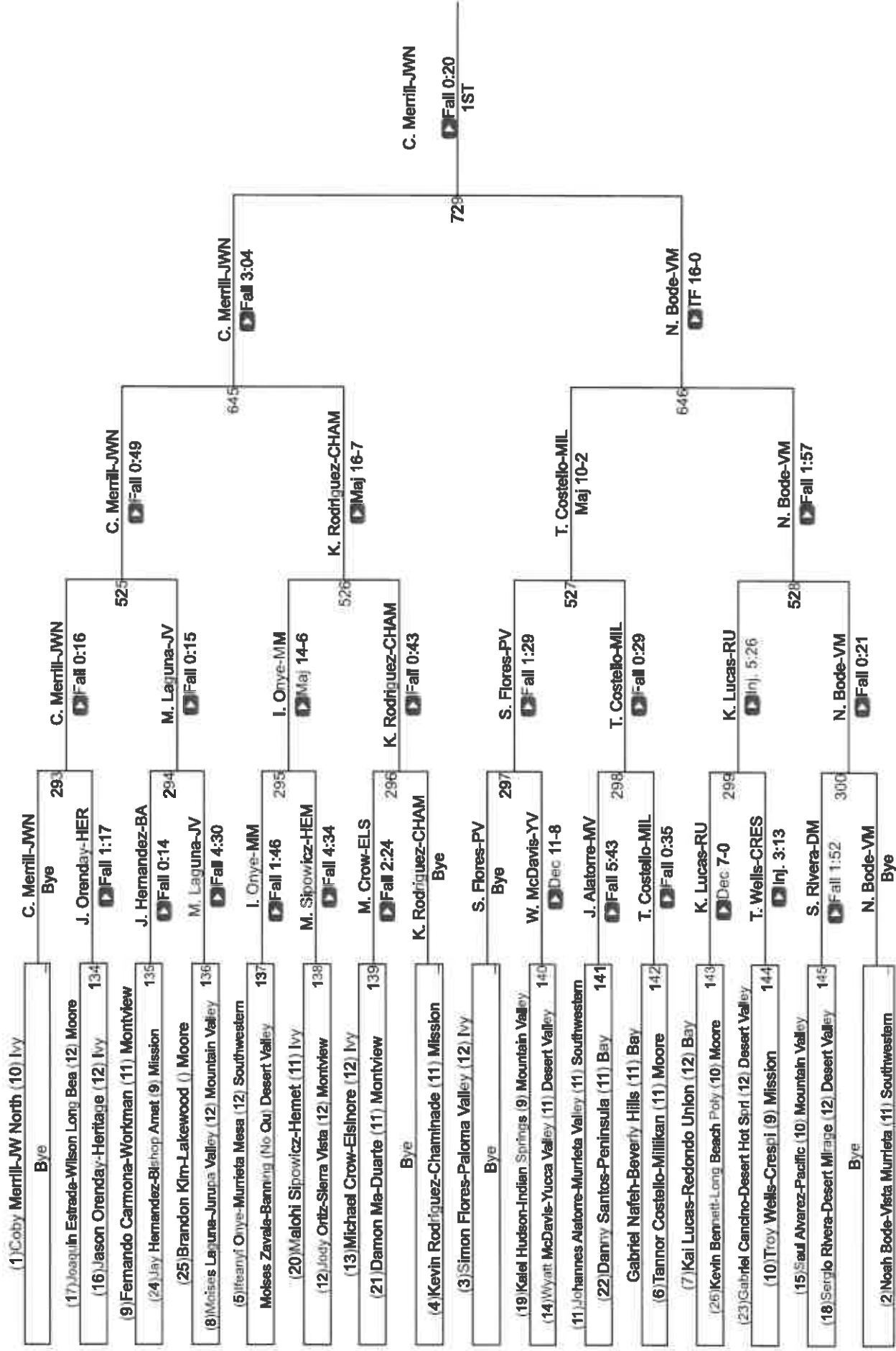

EIF Qualifier 215

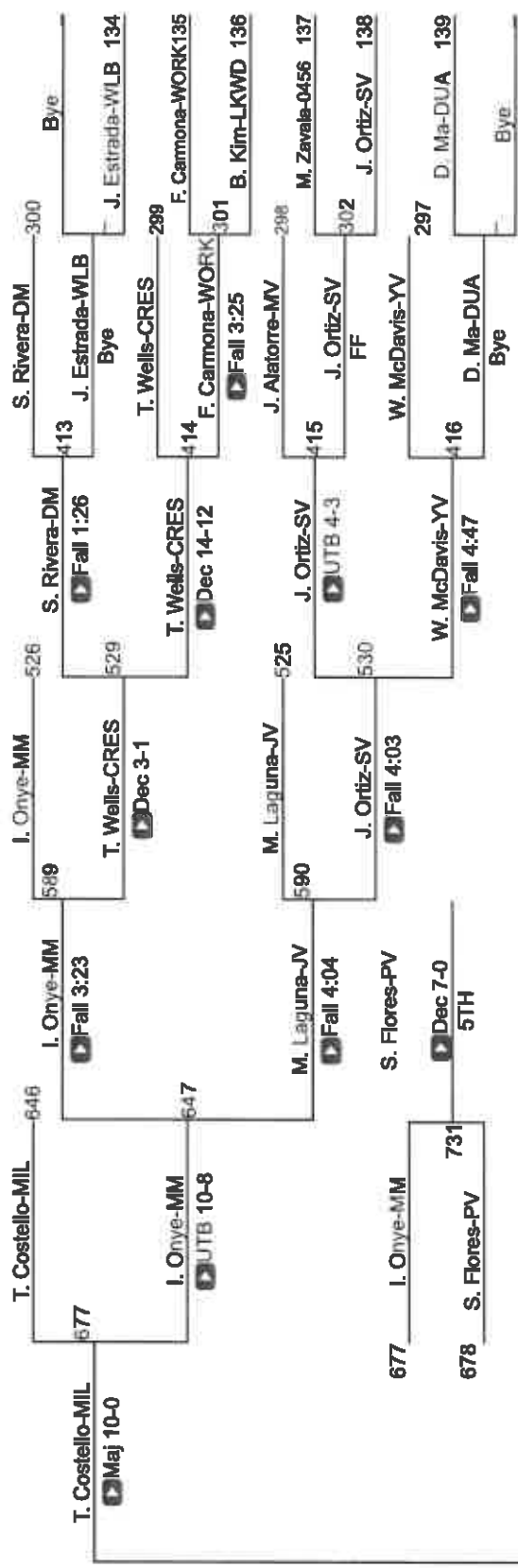

K. Rodriguez-CHAM

Fall 1:53
 3RD

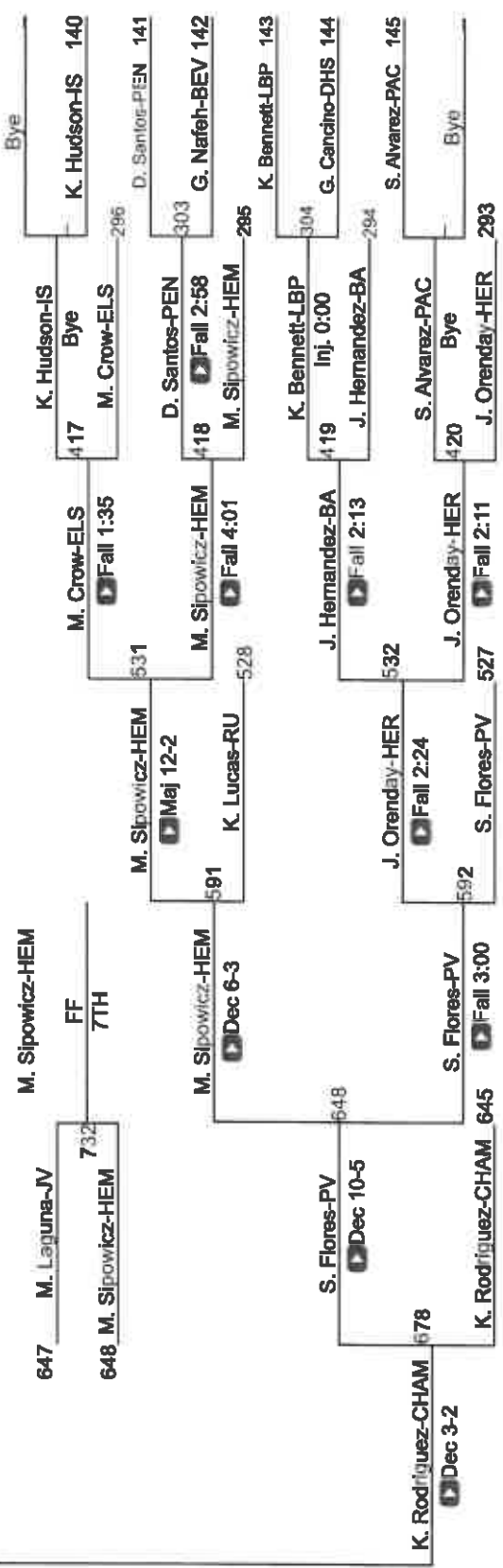

Fall 1:53
 3RD

EIF SS Boys Individuals Southern Div

EIF Qualifier 285

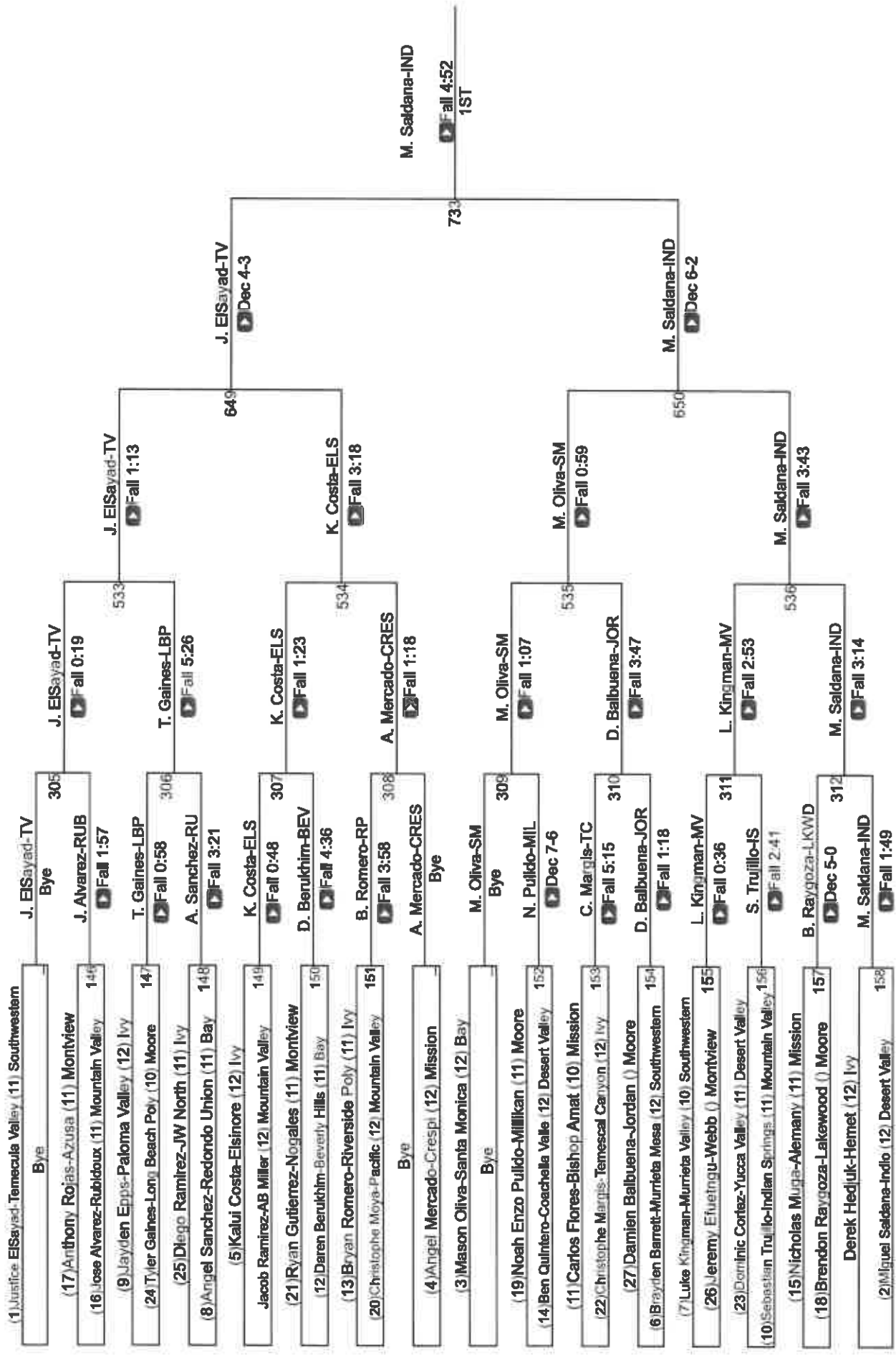

CIF Qualifier 285

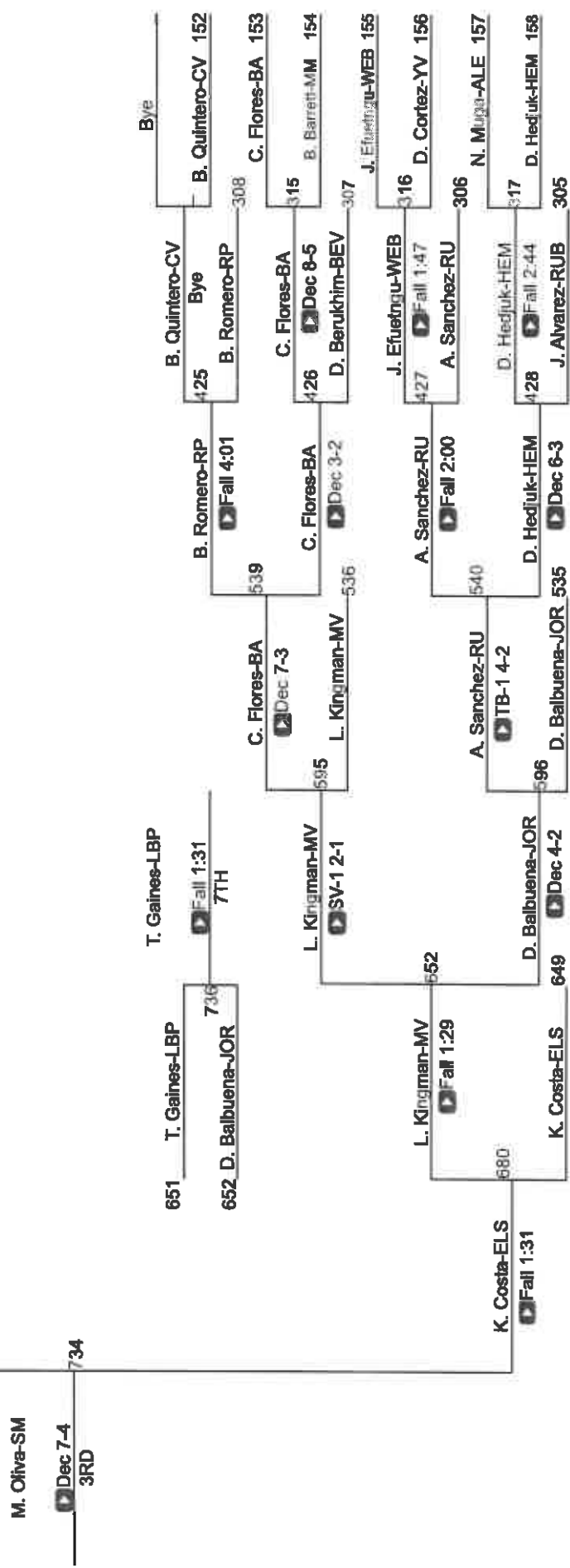
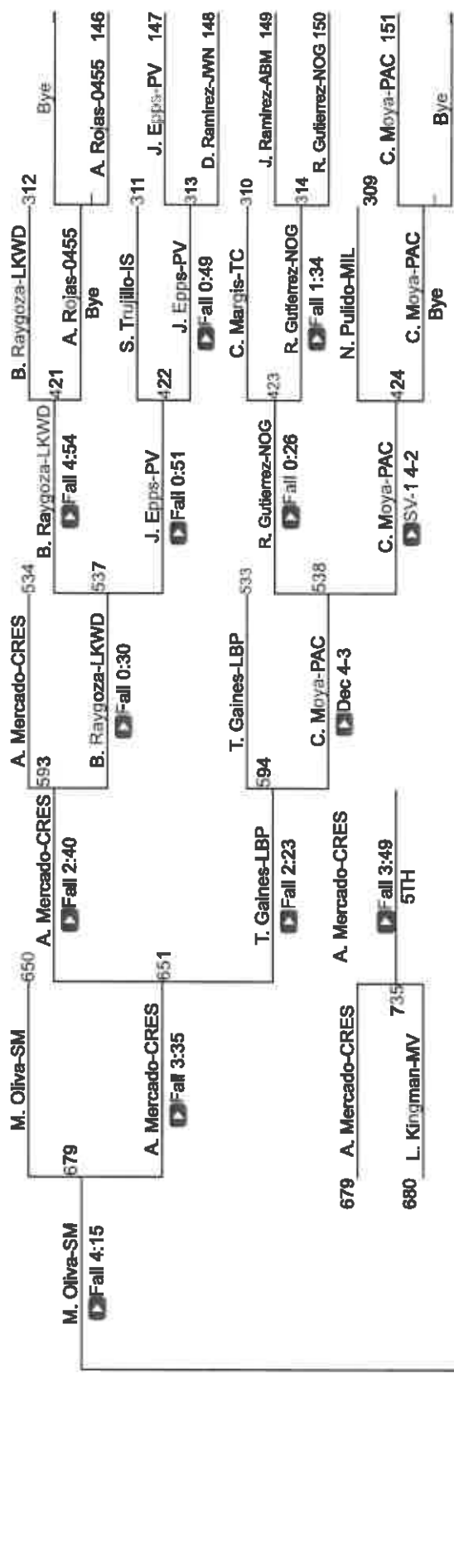

CIF-SS Ford Boys Wrestling Masters Meet

Palm Springs High School February 16, 2024



Placera			Blue 106 Pounds			Blue 150 Pounds			Team Score Final	
1st	Caine Martin	Camarillo	1st	Brock Mantanona	Palm Desert	1	St John Bosco	254.5		
2nd	Zachary Samano	Chino	2nd	Tristan Fernandez	Bonita	2	Fountain Valley	167.5		
3rd	Logan Hansen	Royal	3rd	Yazir Tellez	St John Bosco	3	Palm Desert	163		
4th	Davis Shaposhnick	Great Oak	4th	Jacob Beldon	San Clemente	4	Calvary Chapel SA	128		
5th	Daniel Mendoza	Victor Valley	5th	Felicitio Nunez	Shadow Hills	5	Canyon Springs	123		
6th	Marchello Calavitta	Esperanza	6th	Gabriel Lemos	Temecula Valley	6	Chaminade	104.5		
						7	Northview	100		
						8	Walnut	81.5		
						9	Chino	82		
						10	Eleanor Roosevelt	73		
						11	Etwanda	73		
						12	Royal	71		
						13	Corona Del Mar	69		
						14	Paloma Valley	69		
						15	Hesperia	66		
						16	Temecula Valley	65		
						17	Camarillo	59		
						18	Newport Harbor	57.5		
						19	San Marino	52.5		
						20	Servite	48.5		
						21	San Clemente	46		
						22	Mayfair	45		
						23	Esperanza	40		
						24	El Dorado	39		
						25	Sultana	36		
						26	Trabuco Hills	34		
						27	Dana Hills	33.5		
						28	Martin Luther King	32.5		
						29	Lakeview	32		
						30	Norco	32		
						31	JW North	30		
						32	Valencia	28.5		
						33	Indio	28		
						34	Yorba Linda	28		
						35	Cypress	26.5		
						36	Yucaipa	26		
						37	Bonita	25		
						38	Victor Valley	25		
						39	Quartz Hill	23		
						40	Vista Murrieta	23		
						41	Eisenhower	22		
						42	Elsinore	22		
						43	Millikan	22		
						44	Norwalk	22		
						45	Oak Hills	21		
						46	Centennial Corona	20		
						47	Villa Park	20		
						48	Rim of the World	19.5		
						49	Bishop Amat	19		
						50	Chaparral	19		
						51	Highland	18		
						52	West Valley	17.5		
						53	Great Oak	17		
						54	South Torrance	17		
						55	Irvine	16		
						56	Los Ocos	16		
						57	Ayala	15		
						58	Shadow Hills	15		
						59	Laguna Hills	14.5		
						60	Mater Del	14		
						61	Moorpark	14		
						62	Peris	14		
						63	Santa Fe	14		
						64	Capo Valley	13		
						65	Citrus Valley	12		
						66	Aliso Niguel	11		
						67	Buena	11		
						68	Cerritos	11		
						69	Western	10.5		

CIF-SS Ford Boys Wrestling Masters Meet

Palm Springs High School

February 16, 2024



Placers			Gold 106 Pounds			Gold 150 Pounds			Team Score Final	
1st	Hunter Jauregul	Fountain Valley	1st	Mikel David Uyemura	San Marino	1	St John Bosco	264.5		
2nd	Marcus Tolentino	Northview	2nd	Sean Otero	Norwalk	2	Fountain Valley	167.5		
3rd	Xavier Manzo	Canyon Springs	3rd	Anthony Manno	Newport Harbor	3	Palm Desert	163		
4th	Masimo Ortiz	Calvary Chapel SA	4th	Chris Angulano	Millikan	4	Calvary Chapel SA	128		
5th	Rikki Villaseñor	Newport Harbor	5th	Christian Stoerber	Fountain Valley	5	Canyon Springs	123		
6th	Caydin Chan	San Clemente	6th	Isaac Rea	Lakeside	6	Chaminade	104.5		
						7	Northview	100		
						8	Walnut	91.5		
						9	Chino	82		
						10	Eleanor Roosevelt	73		
						11	Etiwanda	73		
						12	Royal	71		
						13	Corona Del Mar	69		
						14	Paloma Valley	69		
						15	Hesperia	66		
						16	Temecula Valley	65		
						17	Camarillo	59		
						18	Newport Harbor	57.5		
						19	San Marino	52.5		
						20	Servite	48.5		
						21	San Clemente	48		
						22	Mayfair	45		
						23	Esperanza	40		
						24	El Dorado	39		
						25	Sultana	38		
						26	Trabuco Hills	34		
						27	Dana Hills	33.5		
						28	Martin Luther King	32.5		
						29	Lakeside	32		
						30	Norco	32		
						31	JW North	30		
						32	Valencia	28.5		
						33	Indio	28		
						34	Yorba Linda	28		
						35	Cypress	26.5		
						36	Yucaipa	26		
						37	Bonita	25		
						38	Victor Valley	25		
						39	Quartz Hill	23		
						40	Vista Murrieta	23		
						41	Eisenhower	22		
						42	Elsinore	22		
						43	Millikan	22		
						44	Norwalk	22		
						45	Oak Hills	21		
						46	Centennial Corona	20		
						47	Villa Park	20		
						48	Rim of the World	19.5		
						49	Bishop Amat	19		
						50	Chaparral	19		
						51	Highland	18		
						52	West Valley	17.5		
						53	Great Oak	17		
						54	South Torrance	17		
						55	Irvine	16		
						56	Los Ocas	16		
						57	Ayala	15		
						58	Shadow Hills	15		
						59	Laguna Hills	14.5		
						60	Mater Del	14		
						61	Moorpark	14		
						62	Perris	14		
						63	Santa Fe	14		
						64	Capo Valley	13		
						65	Citrus Valley	12		
						66	Aliso Niguel	11		
						67	Buena	11		
						68	Cerritos	11		
						69	Western	10.5		

GIF SS Boys Ford Masters Wrestling Meet

Blue 106

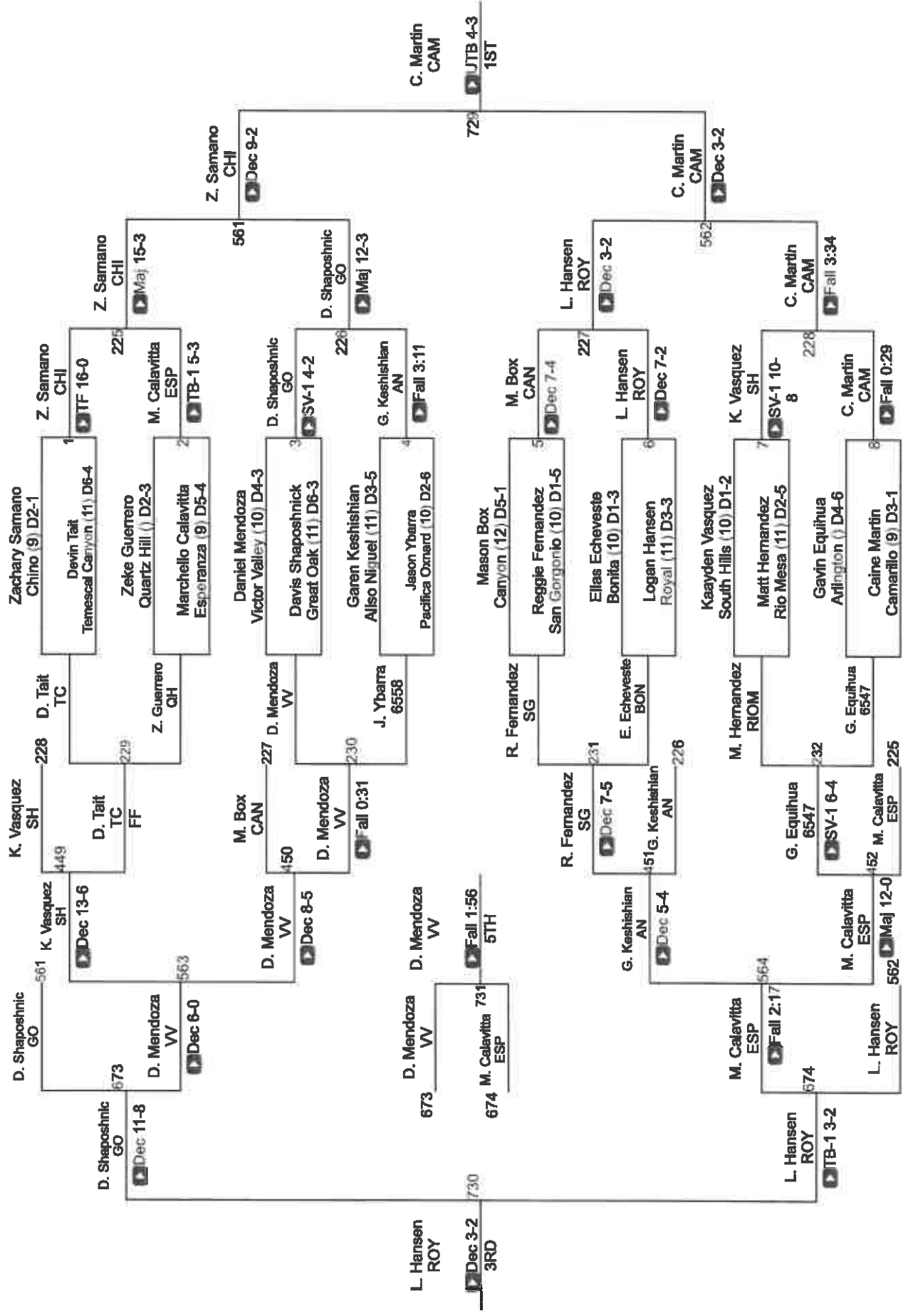

CIF SS Boys Ford Masters Wrestling Meet

Blue 120

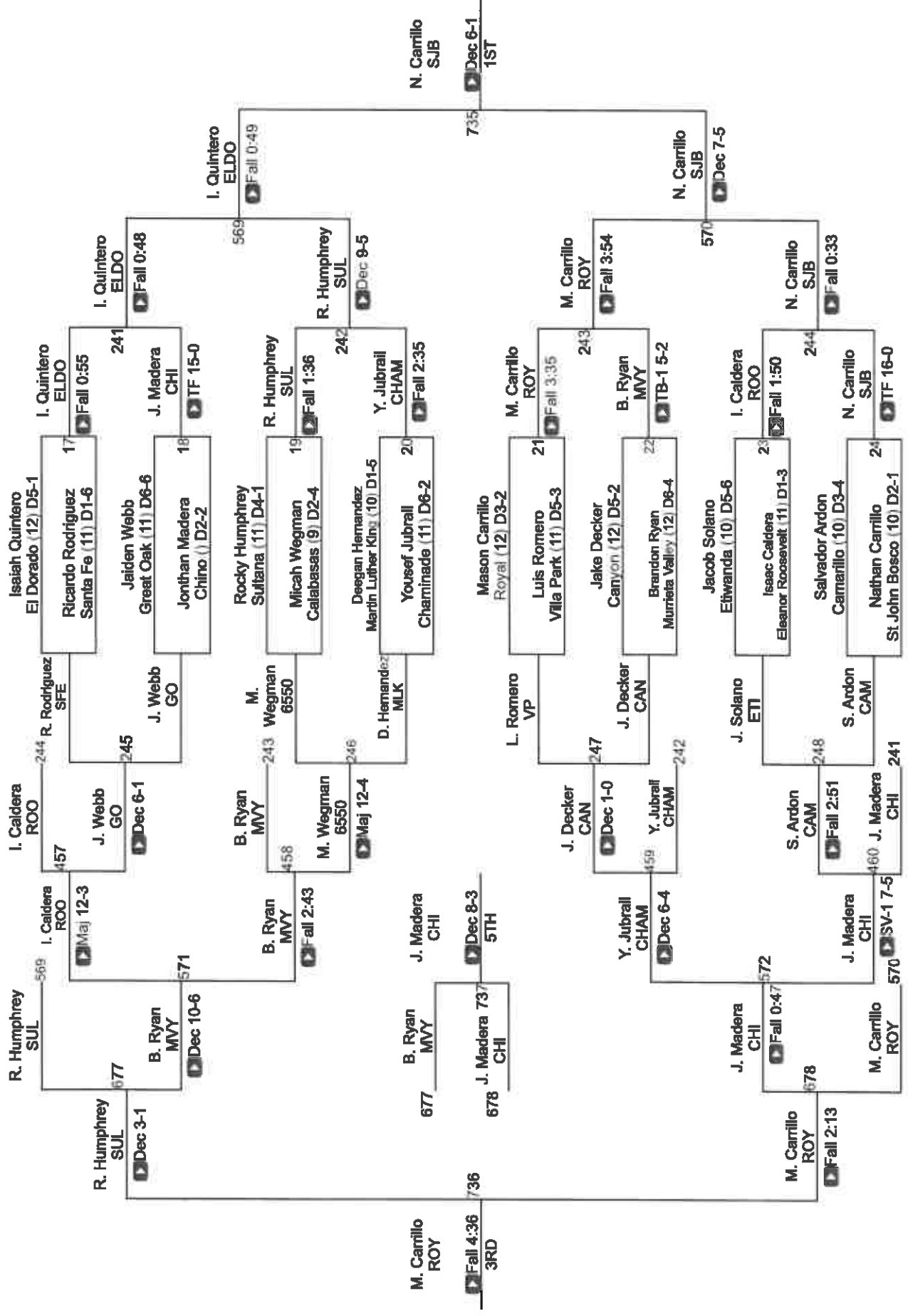

CIF SS Boys Ford Masters Wrestling Meet

Blue 126

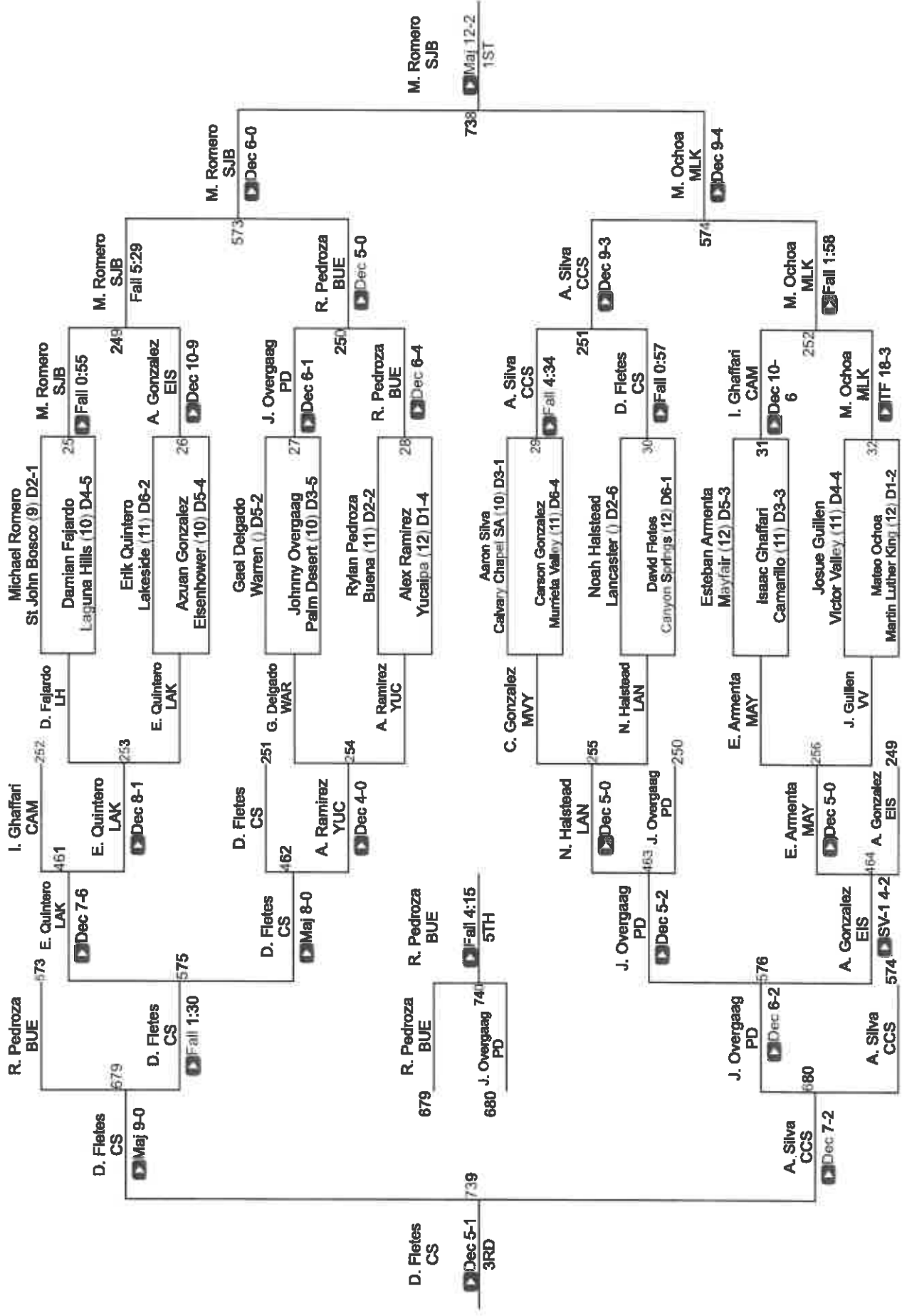

EIF SS Boys Ford Masters Wrestling Meet

Blue 150

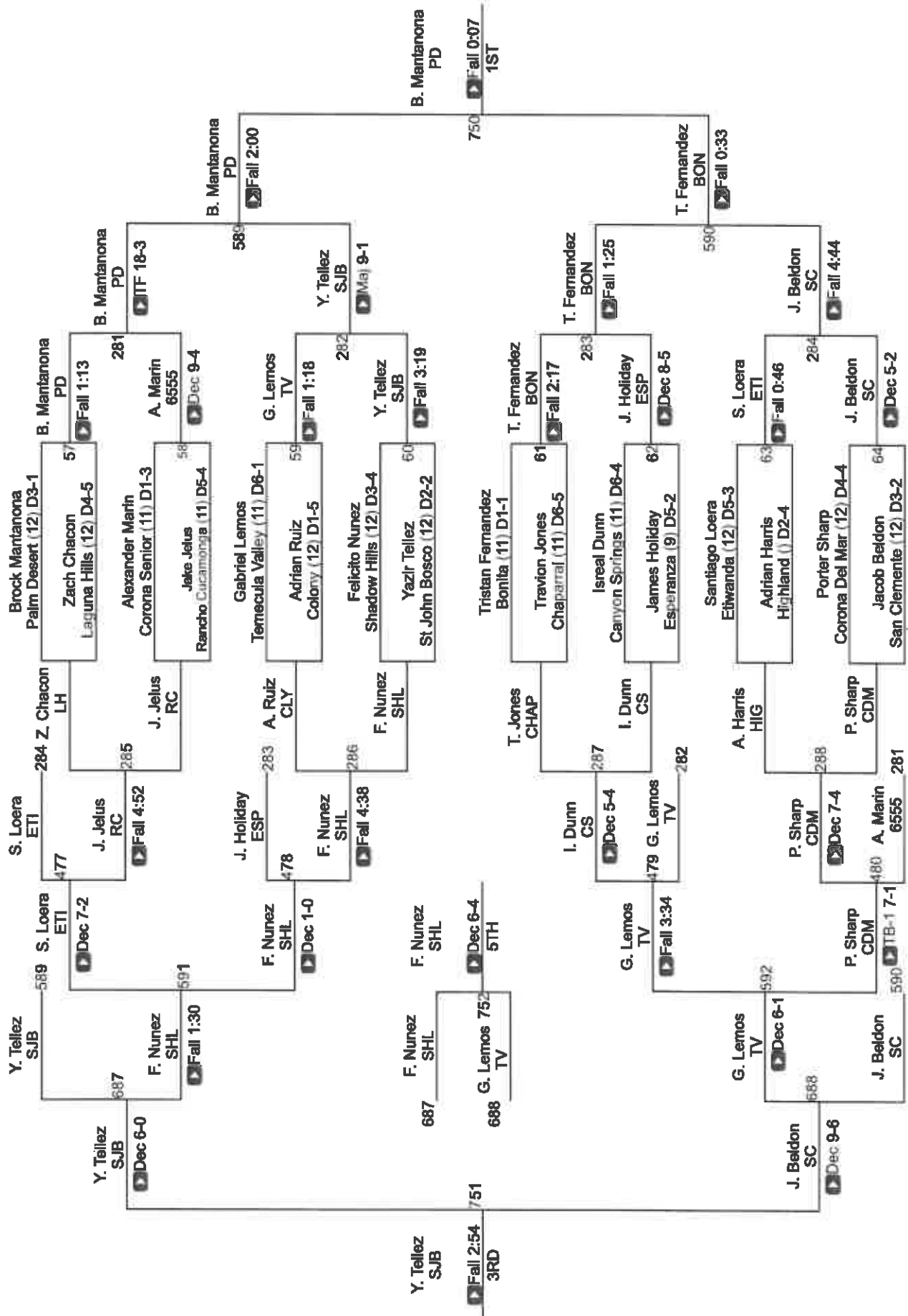

CIF SS Boys Ford Masters Wrestling Meet

Blue 157

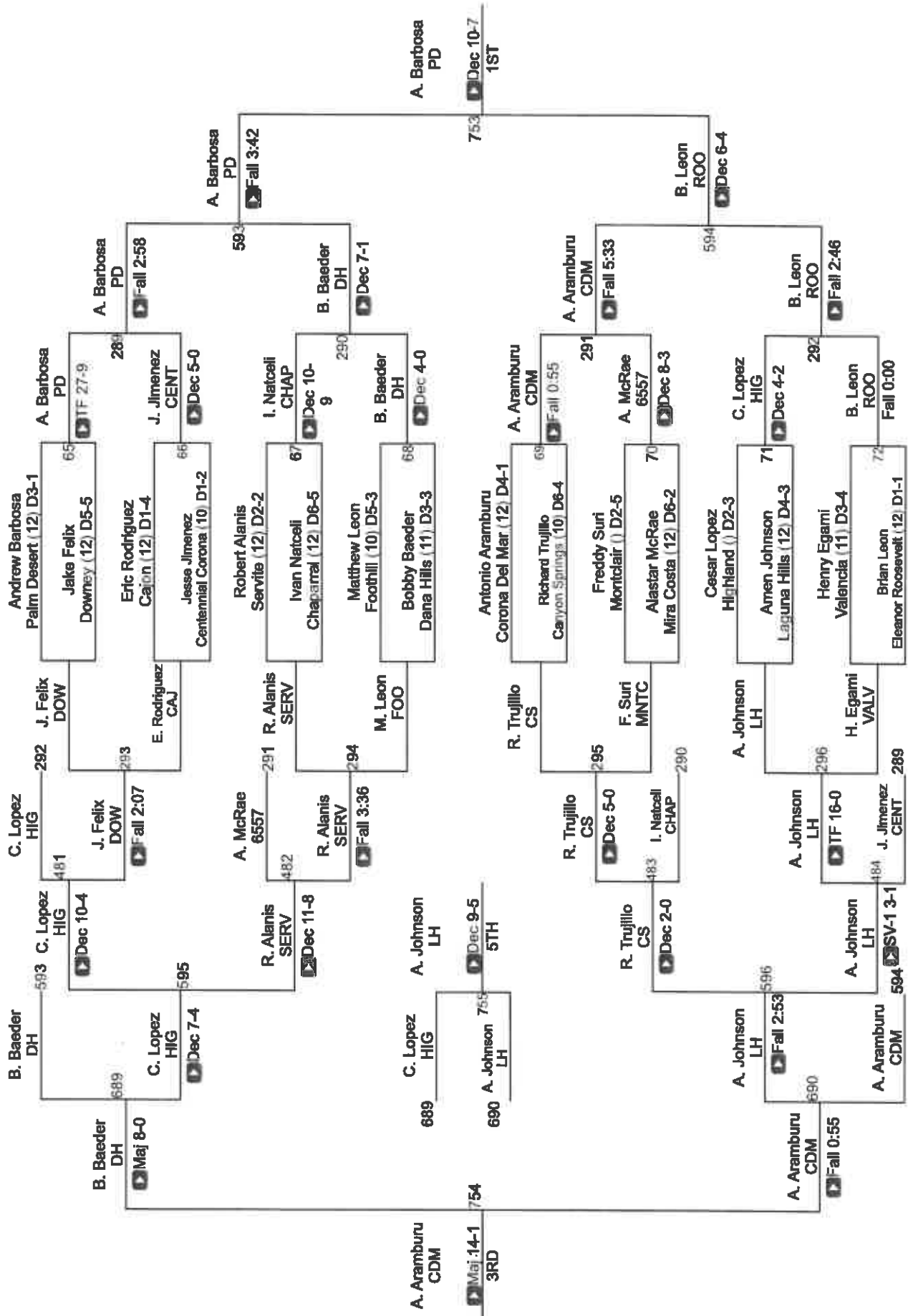

EIF SS Boys Ford Masters Wrestling Meet

Blue 165

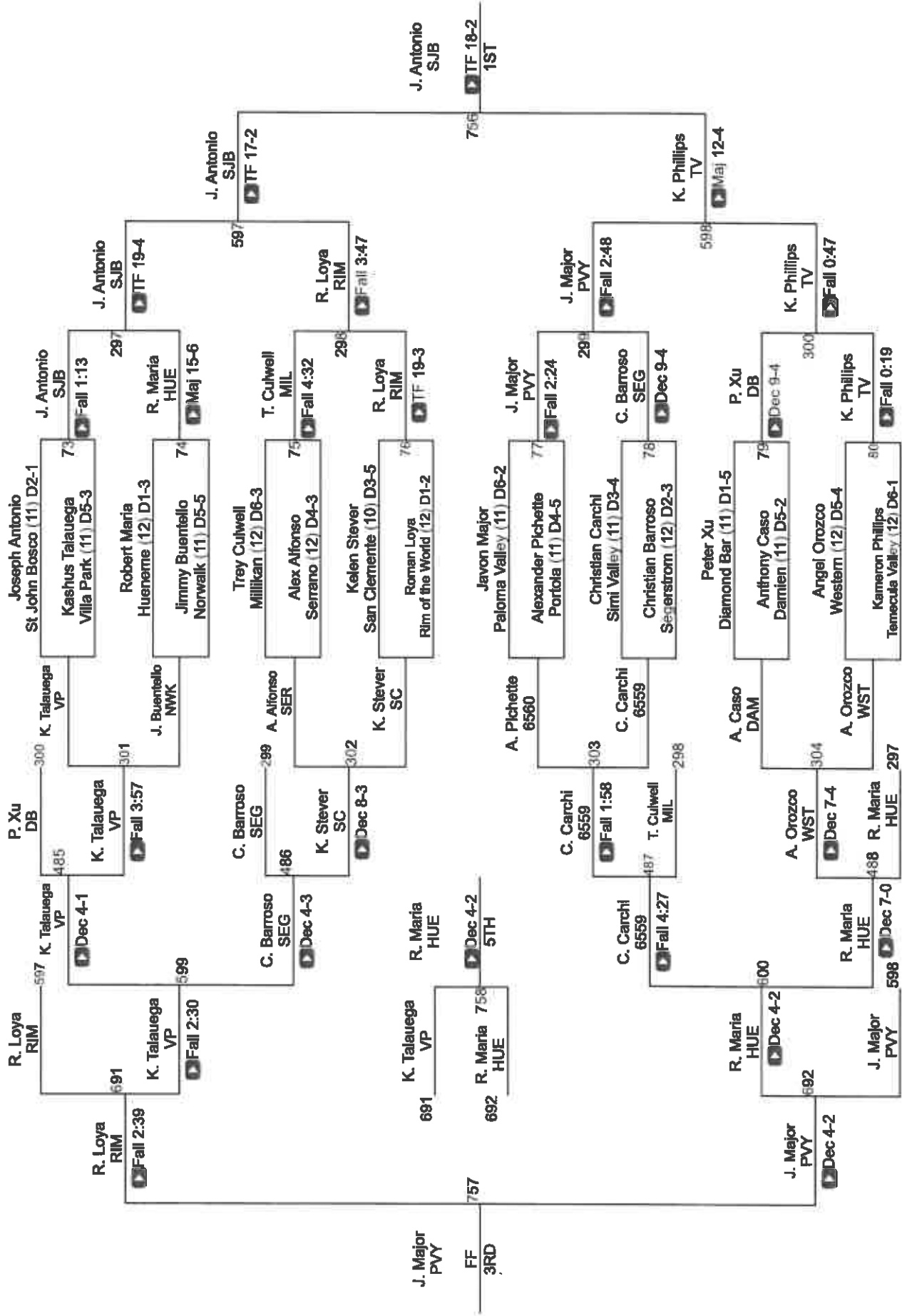

CIF SS Boys Ford Masters Wrestling Meet

Blue 190

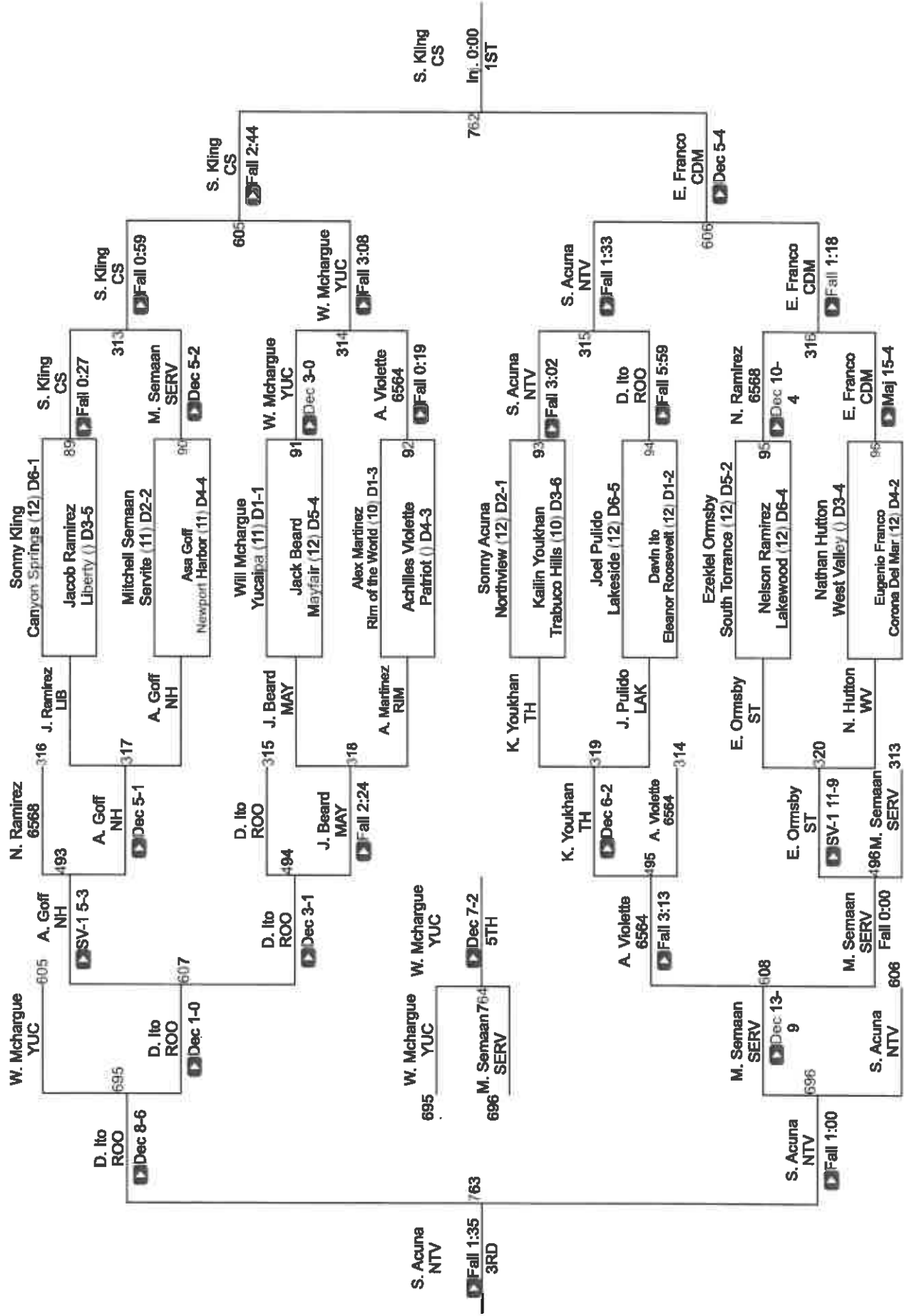

GIFSS Boys Ford Masters Wrestling Meet

Blue 285

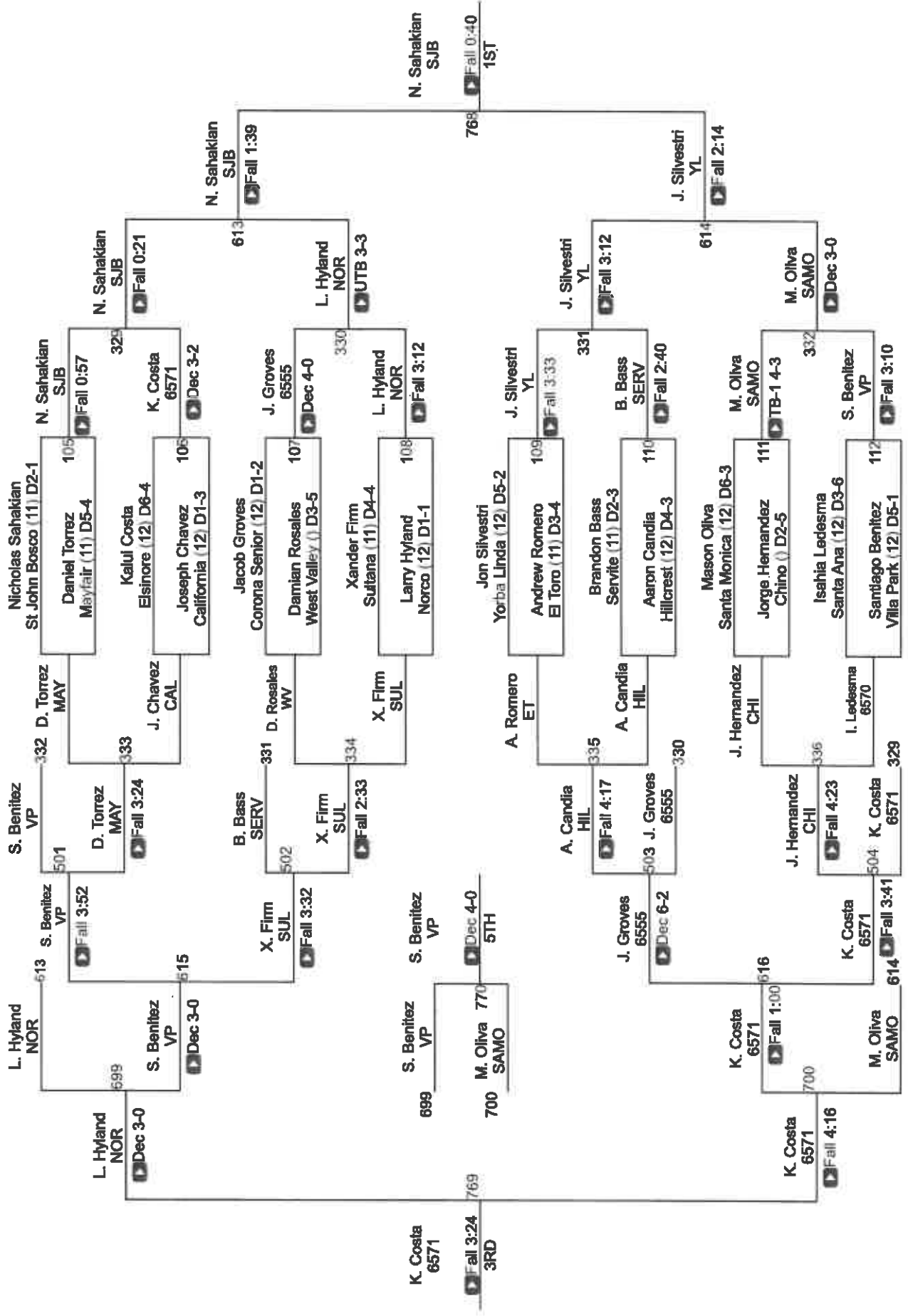

EIF SS Boys Ford Masters Wrestling Meet

Gold 120

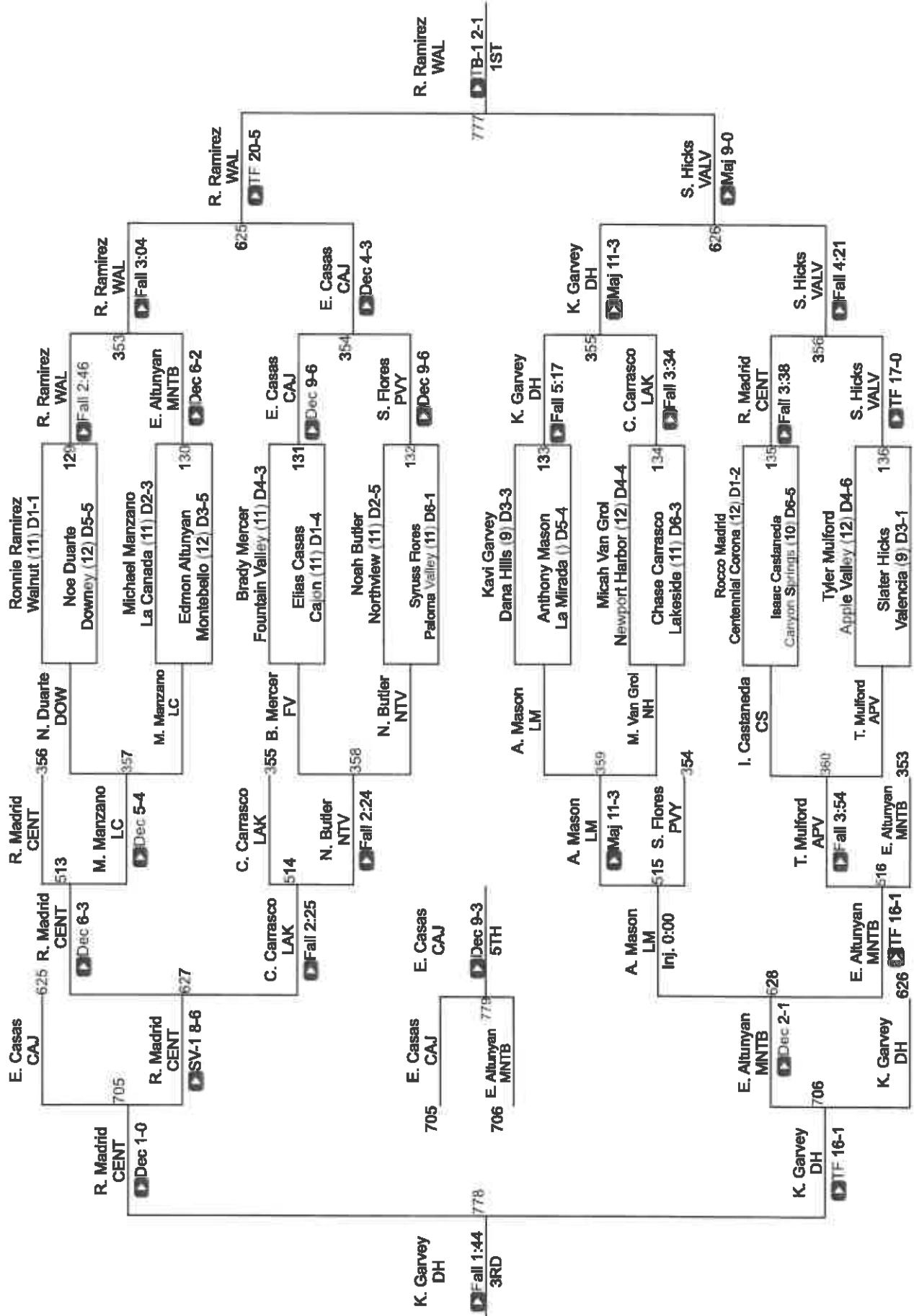

EIF SS Boys Ford Masters Wrestling Meet

Gold 126

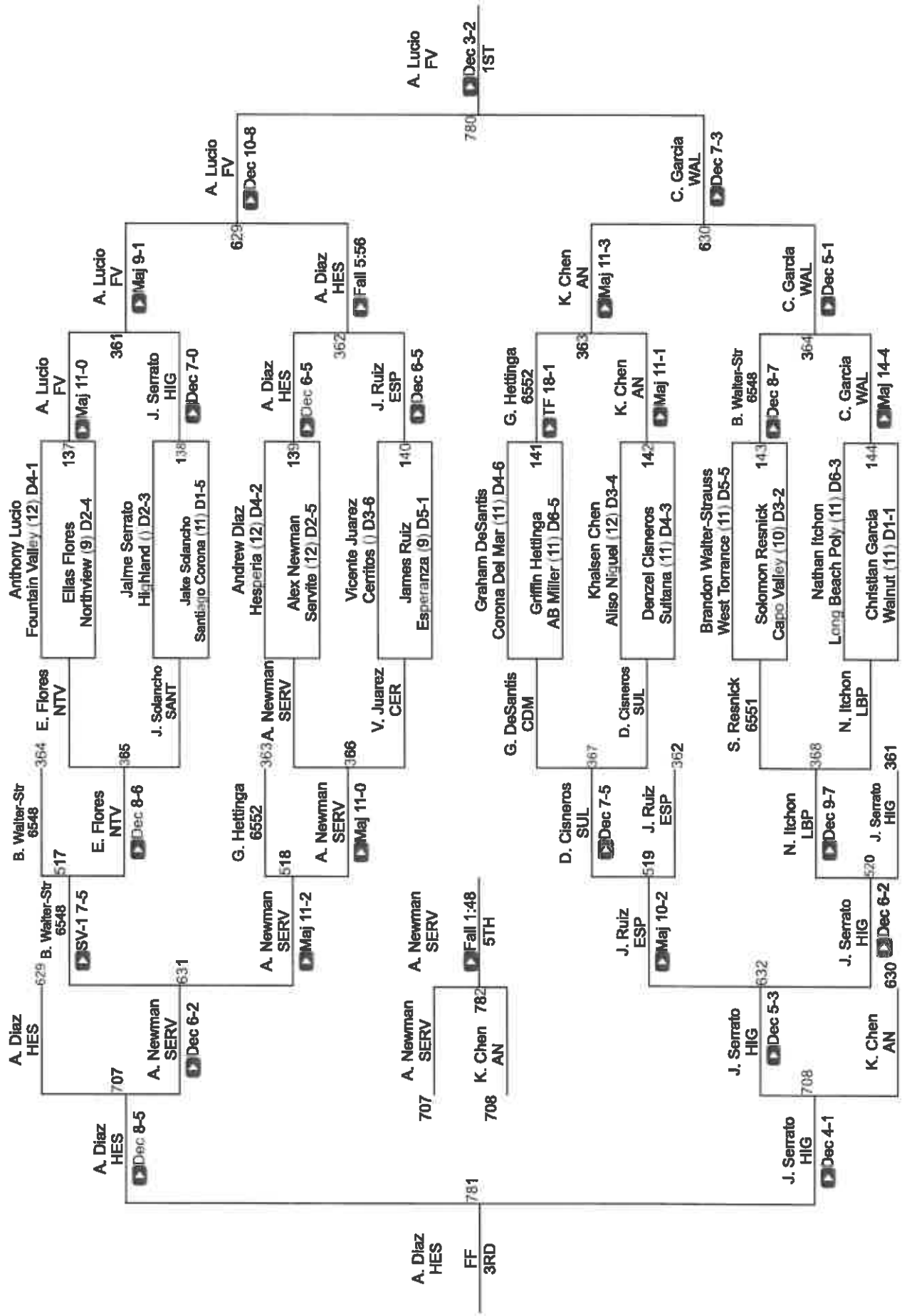

CIF SS Boys Ford Masters Wrestling Meet

Gold 138

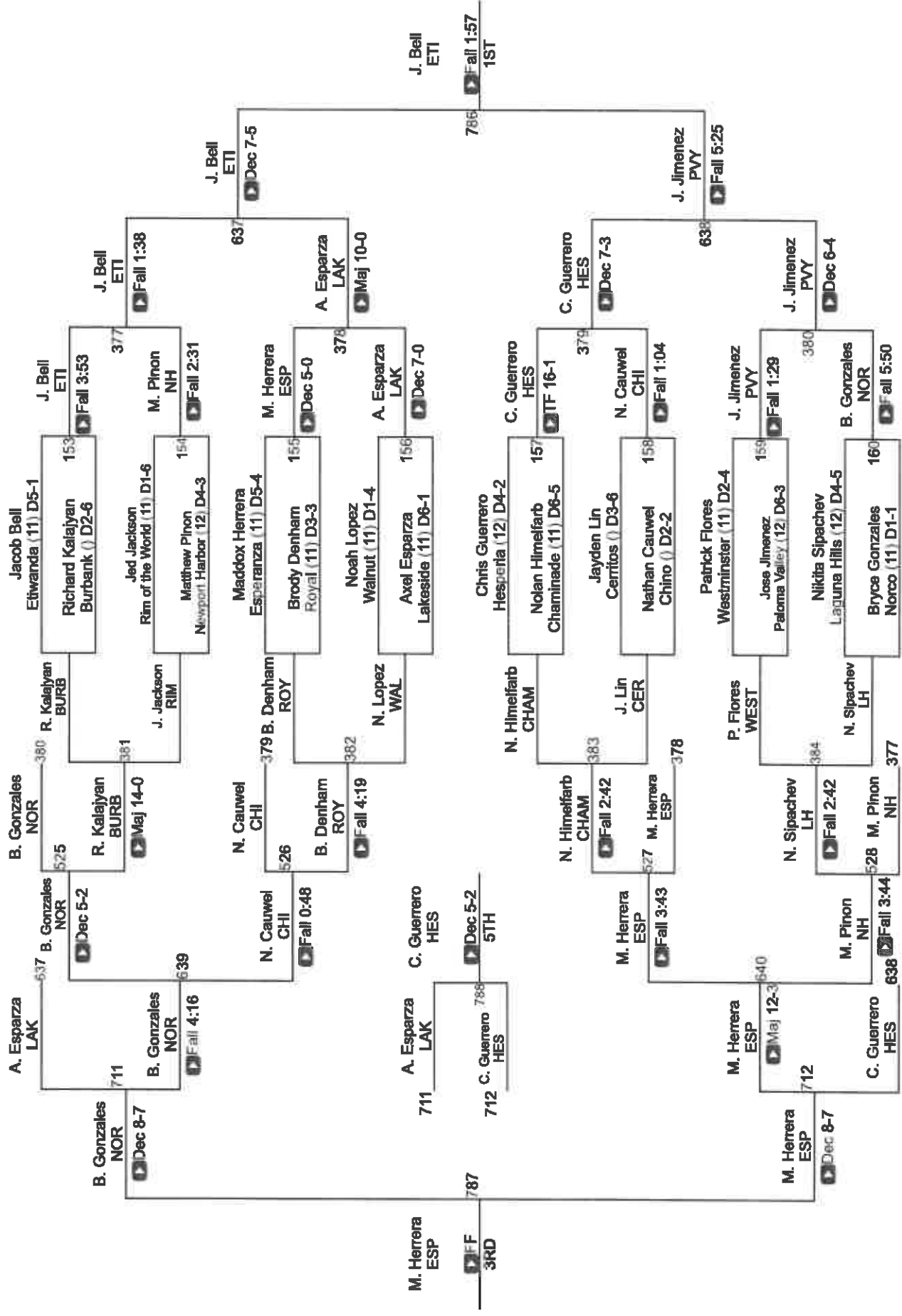

CIF SS Boys Ford Masters Wrestling Meet

Gold 144

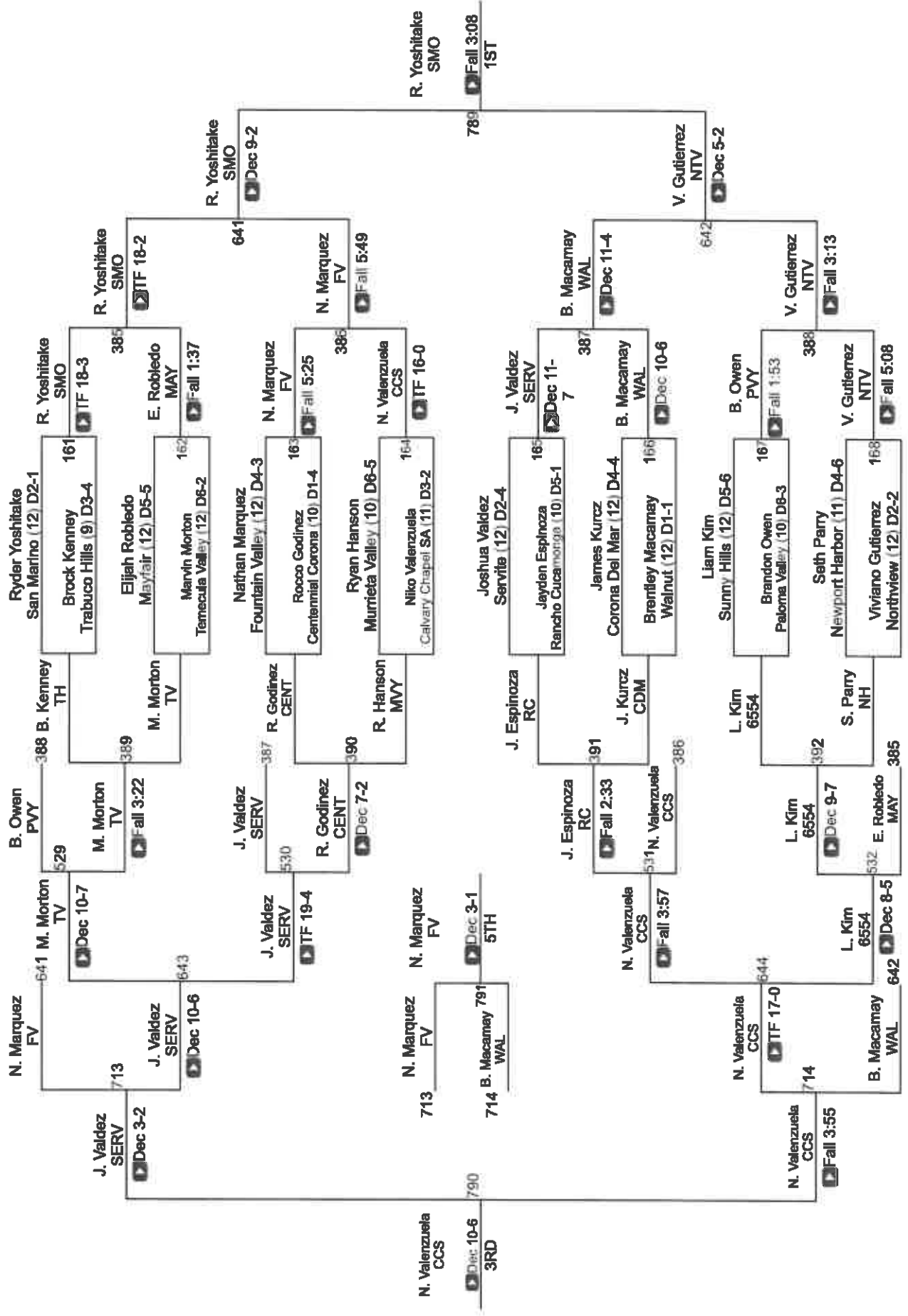

CIF SS Boys Ford Masters Wrestling Meet

Gold 150

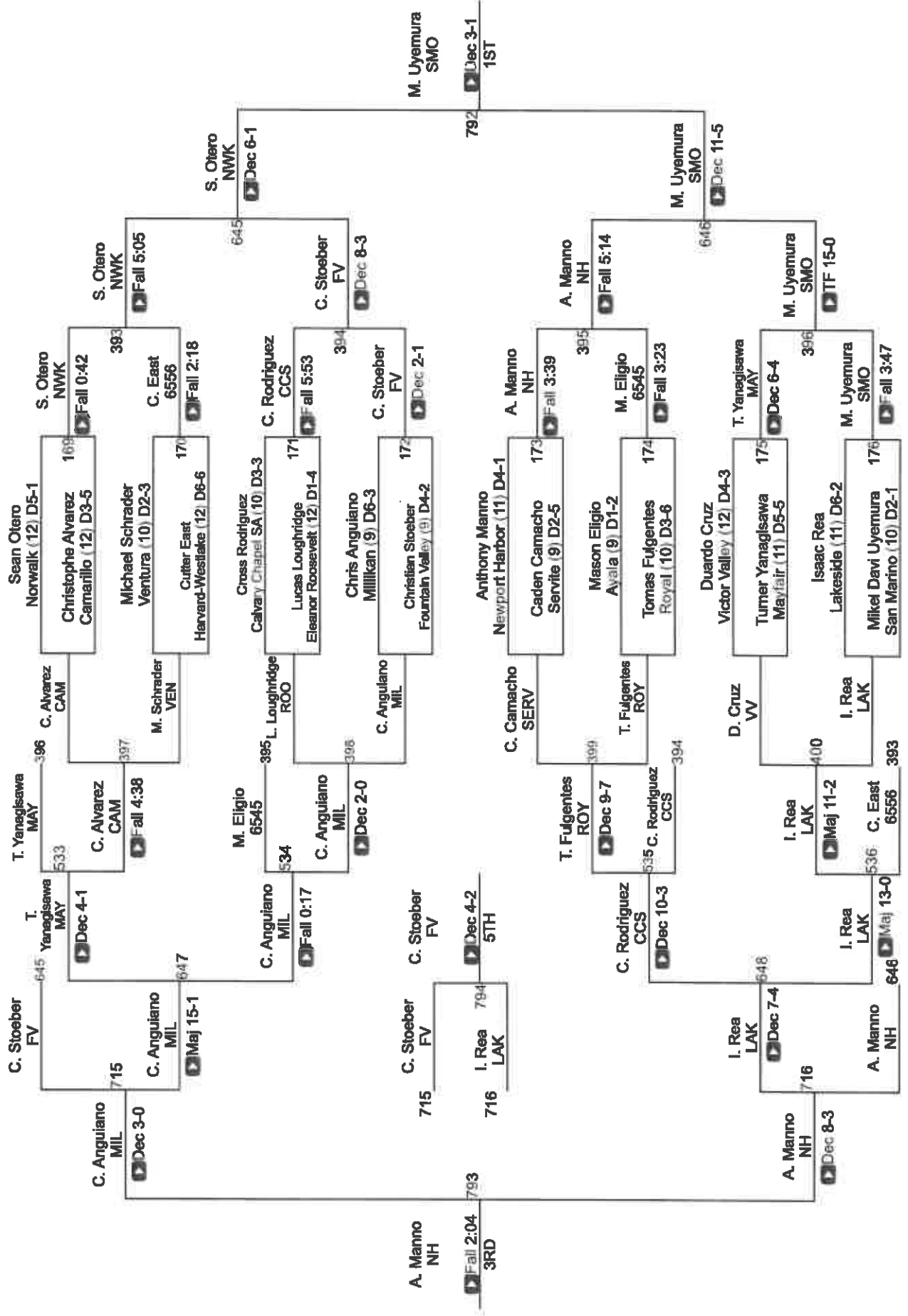

CIF SS Boys Ford Masters Wrestling Meet

Gold 157

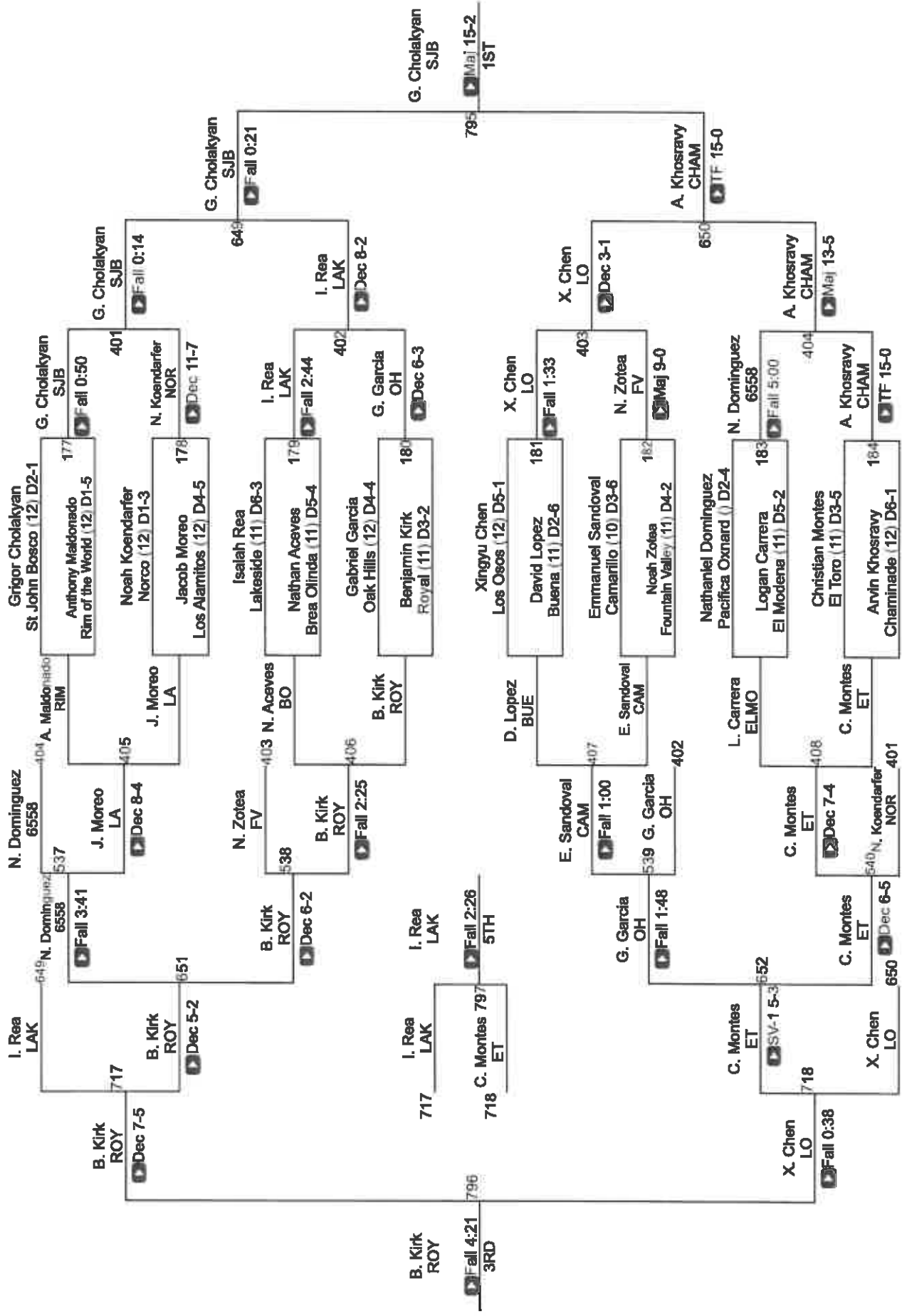

CIF SS Boys Ford Masters Wrestling Meet

Gold 165

