

CIF SS Boys Individuals

Central Division

Yucaipa High School

February 10-11, 2023



Lower Weight MVP

Ronnie Ramirez
Walnut
113 Pounds

Upper Weight MVP

Marquize Brown
Glendora
170 Pounds

Placers

106 Pounds			152 Pounds			Team Score Final		
1st	Camilo Ramirez	Walnut	1st	Brian Leon	Eleanor Roosevelt	1	Eleanor Roosevelt	311.5
2nd	Casa Elias	Cajon	2nd	Hernandez Mason	Citrus Valley	2	Walnut	230
3rd	Isaac Castaneda	Martin Luther King	3rd	Gino Martinez	Centennial Corona	3	Yucaipa	211
4th	Zeke Guerrero	South Hills	4th	Joseph Contreras	Walnut	4	Alta Loma	131
5th	Pedro Quezada	Centennial Corona	5th	Nathaniel Gonzalez	Bonita	5	Citrus Valley	128
6th	Isaac Caldera	Eleanor Roosevelt	6th	Robert Maria	Hueneme	6	Bonita	127
7th	Elias Echeveste	Bonita	7th	Espino Maximiliano	Cajon	7	Centennial Corona	121
8th	Joel Gallarzo	Pomona	8th	Lopez Jacob	Yucaipa	8	Santa Fe	121
113 Pounds			160 Pounds			9	Norco	120
1st	Ronnie Ramirez	Walnut	1st	Javier Montes	Eleanor Roosevelt	10	Martin Luther King	106.5
2nd	Jason Saenz	Eleanor Roosevelt	2nd	Kevin Camacho	Redlands East Valley	11	Redlands East Valley	89
3rd	Jordan Lopez	Redlands East Valley	3rd	Roman Loya	Rim of the World	12	Glendora	72
4th	Rocco Madrid	Centennial Corona	4th	Jesse Jimenez	Centennial Corona	13	South Hills	70
5th	Ramirez Alexander	Yucaipa	5th	Peter Xu	Diamond Bar	14	Santiago Corona	67
6th	Jesse Hernandez	California	6th	Thomas Mazzetti	Santiago Corona	15	Cajon	58
7th	Sebastian Teroy	Santa Fe	7th	Noah Koendarfer	Norco	16	Diamond Bar	58
8th	Maximus Gasca	Colony	8th	Jordan Encinas	El Rancho	17	Carter	56
120 Pounds			170 Pounds			18	Rim of the World	48
1st	Christian Garcia	Walnut	1st	Marquize Brown	Glendora	19	Beaumont	43.5
2nd	Luis Solis	Los Altos	2nd	Barrios Ryan	Citrus Valley	20	Channel Islands	42
3rd	Ricardo Ponce	Redlands East Valley	3rd	McHargue Will	Yucaipa	21	Colony	42
4th	Mateo Ochoa	Martin Luther King	4th	Sean Casey	Alta Loma	22	Ayala	41.5
5th	Charles Wallis	Alta Loma	5th	Max Topete	South Hills	23	Colton	41
6th	David Davalos	Santa Fe	6th	Roman Rodriguez	Centennial Corona	24	Nordhoff	38
7th	Jake Solancho	Santiago Corona	7th	Justin Anderegg	Eleanor Roosevelt	25	Hueneme	37.5
8th	Owen Callaway	Bonita	8th	Omar Correa	Santa Fe	26	Claremont	36
126 Pounds			182 Pounds			27	El Rancho	36
1st	Bryce Gonzales	Norco	1st	Costa Diego	Yucaipa	28	San Geronio	30
2nd	Michael Williams	Eleanor Roosevelt	2nd	Davin Ito	Eleanor Roosevelt	29	Pomona	25
3rd	Aaron Contreras	Walnut	3rd	Simon Bachman	Claremont	30	Los Altos	23.5
4th	Gutierrez Ian	Yucaipa	4th	Marco Guerrero	Santa Fe	31	La Serna	23
5th	Thompson Devin	Citrus Valley	5th	Jackson Evans	Glendora	32	Redlands	18
6th	Dylan Garcia	Bonita	6th	Austin South	Norco	33	Corona Senior	17
7th	Samuel Brunolli	Martin Luther King	7th	Baltazar Alexander	Beaumont	34	Whittier	15
8th	Zain Khan	Alta Loma	8th	Cody Williams	Martin Luther King	35	Bloomington	14
132 Pounds			195 Pounds			36	Rowland	14
1st	Elijah Flores	Walnut	1st	Eli Green	Alta Loma	37	Santa Paula	14
2nd	Julian Aguilar	Eleanor Roosevelt	2nd	Javier Gonzalez	Norco	38	Fillmore	13
3rd	Elijah Flores	Santa Fe	3rd	Barrios Ricardo	Citrus Valley	39	California	12
4th	Lucas Holloway	Santiago Corona	4th	Ramirez Kevin	Yucaipa	40	Edgewood	11
5th	Jose Ramirez	Colton	5th	Michael Trejo	Eleanor Roosevelt	41	Bassett	9
6th	Dewitt Xander	Yucaipa	6th	Ct Clancey	Bonita	42	Wilson Hacienda Heights	4
7th	Joshua Ross	Colony	7th	Emmanuel Akapo	Pomona	43	Ganesh	0
8th	Ryan Libunao	Claremont	8th	Isaac Gomez	Glendora	44	La Puente	0
138 Pounds			220 Pounds					
1st	Daugherty Kieran	Yucaipa	1st	Micah Tofilau	Bonita			
2nd	Paul Knapp	Martin Luther King	2nd	Fernando Rodarte	Eleanor Roosevelt			
3rd	Brently Macamay	Walnut	3rd	Leon Trevor	Citrus Valley			
4th	Nathaniel Zabala	Norco	4th	Martinez Emmanuel	Beaumont			
5th	Lucas Loughridge	Eleanor Roosevelt	5th	Nikolaus Macias	Diamond Bar			
6th	Adrian Ruiz	Colony	6th	Ian Sullins	Alta Loma			
7th	Diego Eligio	Ayala	7th	Fernando Toscano	Santa Fe			
8th	Landon Hernandez	Santiago Corona	8th	Santino Zamora	Colton			
145 Pounds			285 Pounds					
1st	Tristan Fernandez	Bonita	1st	Nathan Rodriguez	Eleanor Roosevelt			
2nd	Noah Vasquez	Eleanor Roosevelt	2nd	Floyd Caleb	Yucaipa			
3rd	Anthony Zuniga	Carter	3rd	Seth Fogle	Centennial Corona			
4th	Moyer Marcus	Citrus Valley	4th	Saul De Leon	Alta Loma			
5th	Timothy Burke	Channel Islands	5th	Levi Sandoval	Carter			
6th	Sergio Campos	San Geronio	6th	Vincent Pineda	Whittier			
7th	Sol McGarey	Nordhoff	7th	Frank Emeterio	Walnut			
8th	Ian Buckley	Santiago Corona	8th	Diego Ventura	Redlands East Valley			

CIF SS Boys Individuals Central Div

CIF Qualifier 106

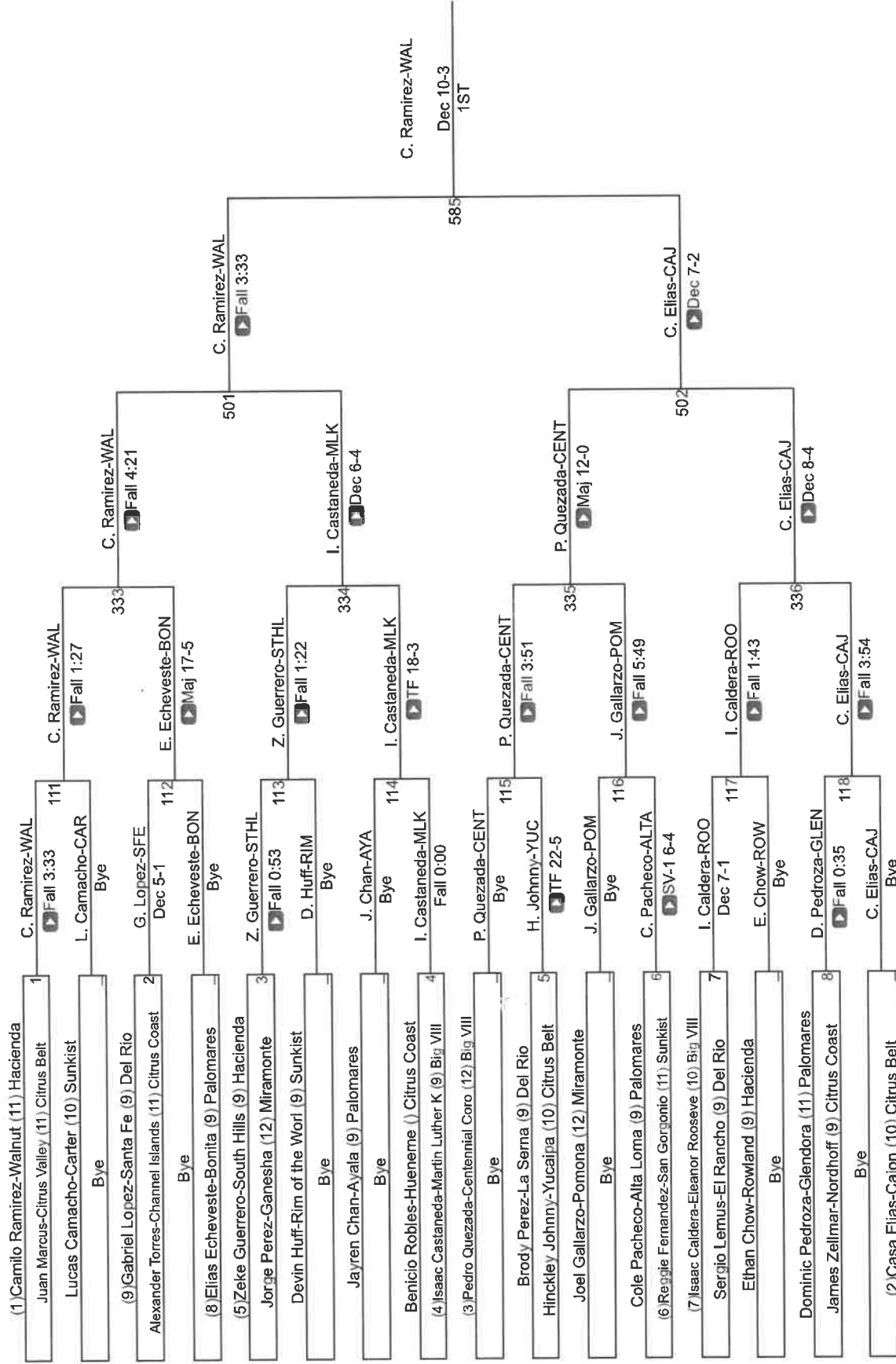

CIF SS Boys Individuals Central Div

CIF Qualifier 113

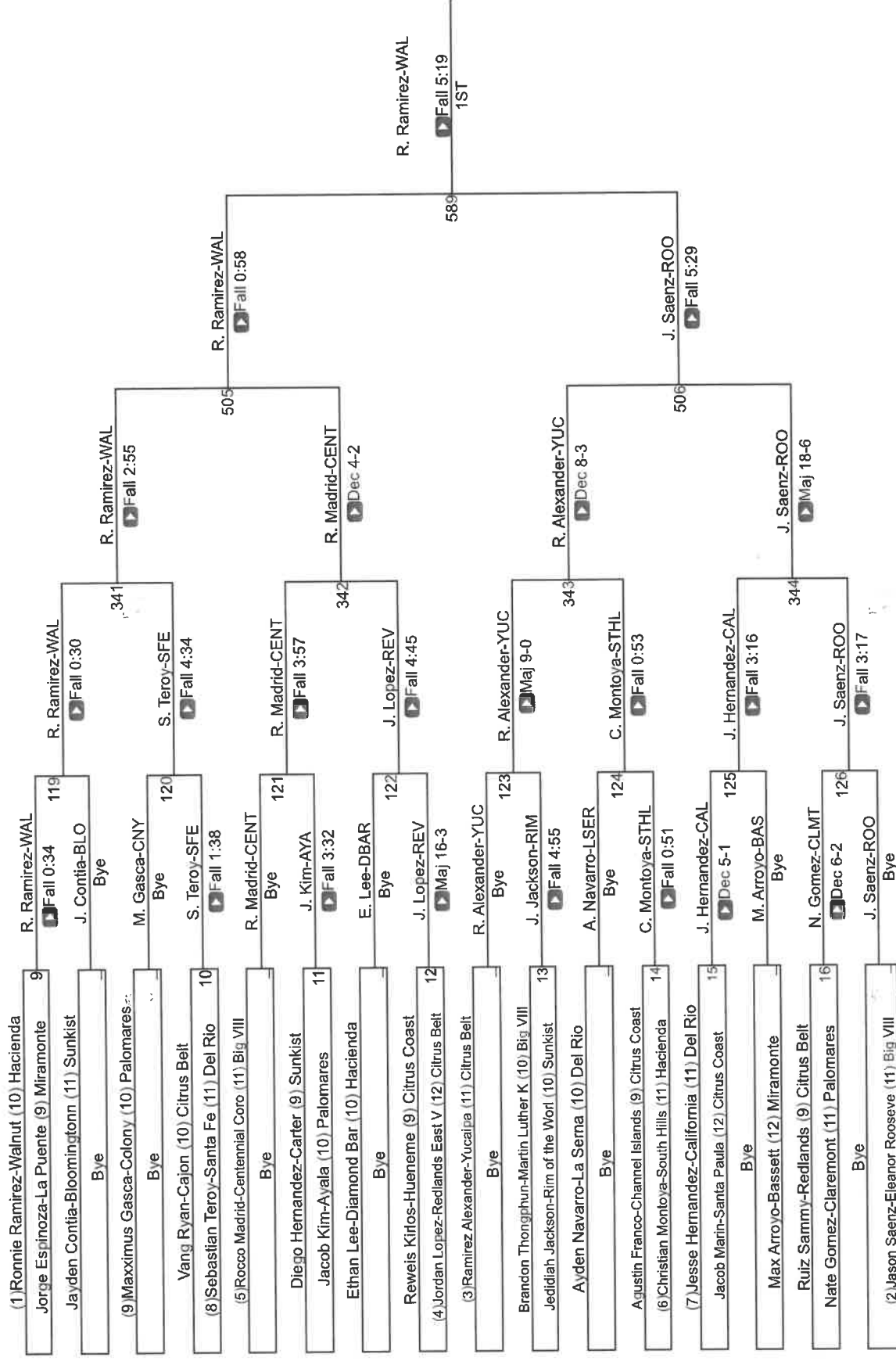

CIF SS Boys Individuals Central Div

CIF Qualifier 120

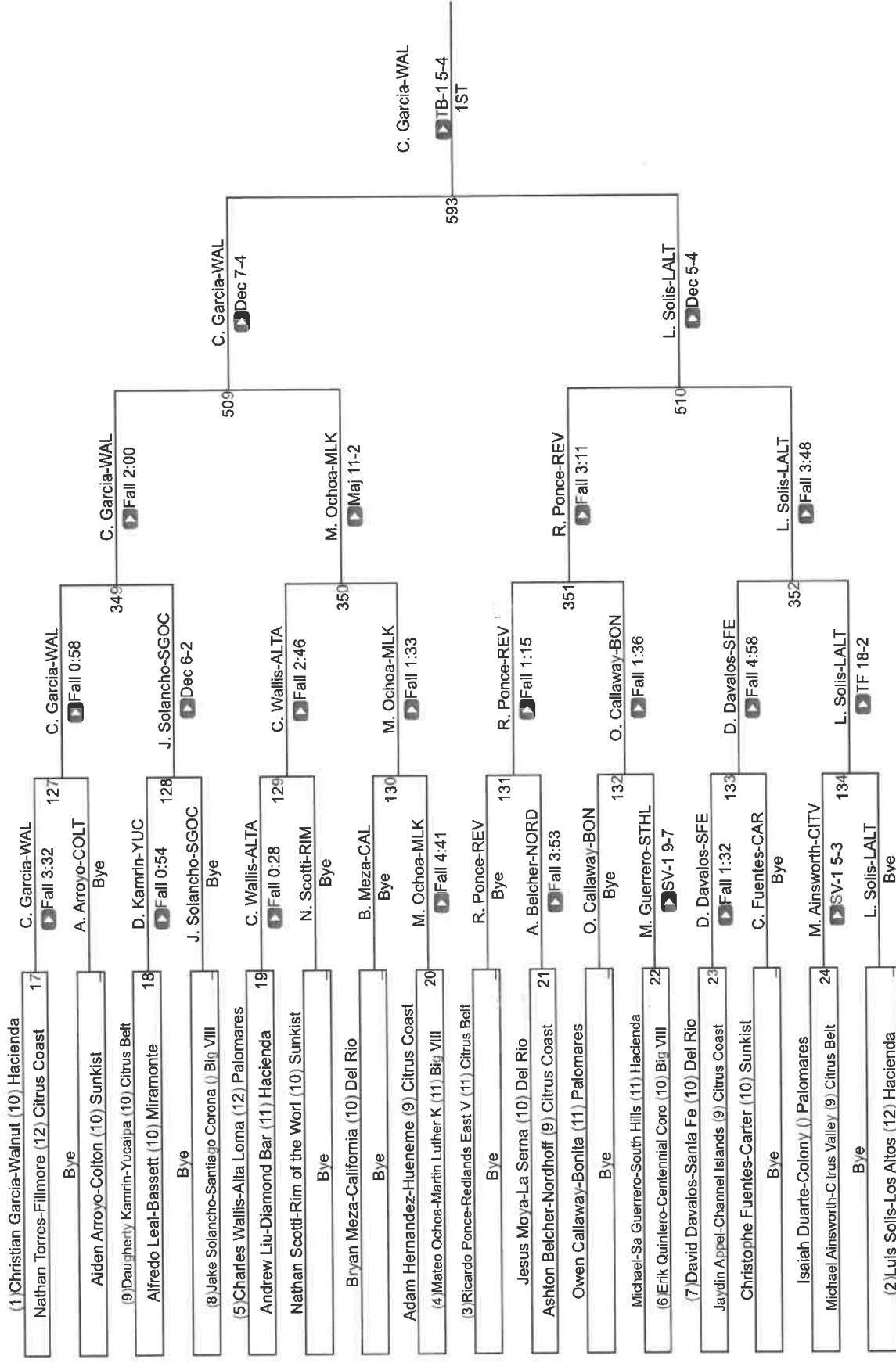

CIF SS Boys Individuals Central Div

CIF Qualifier 126

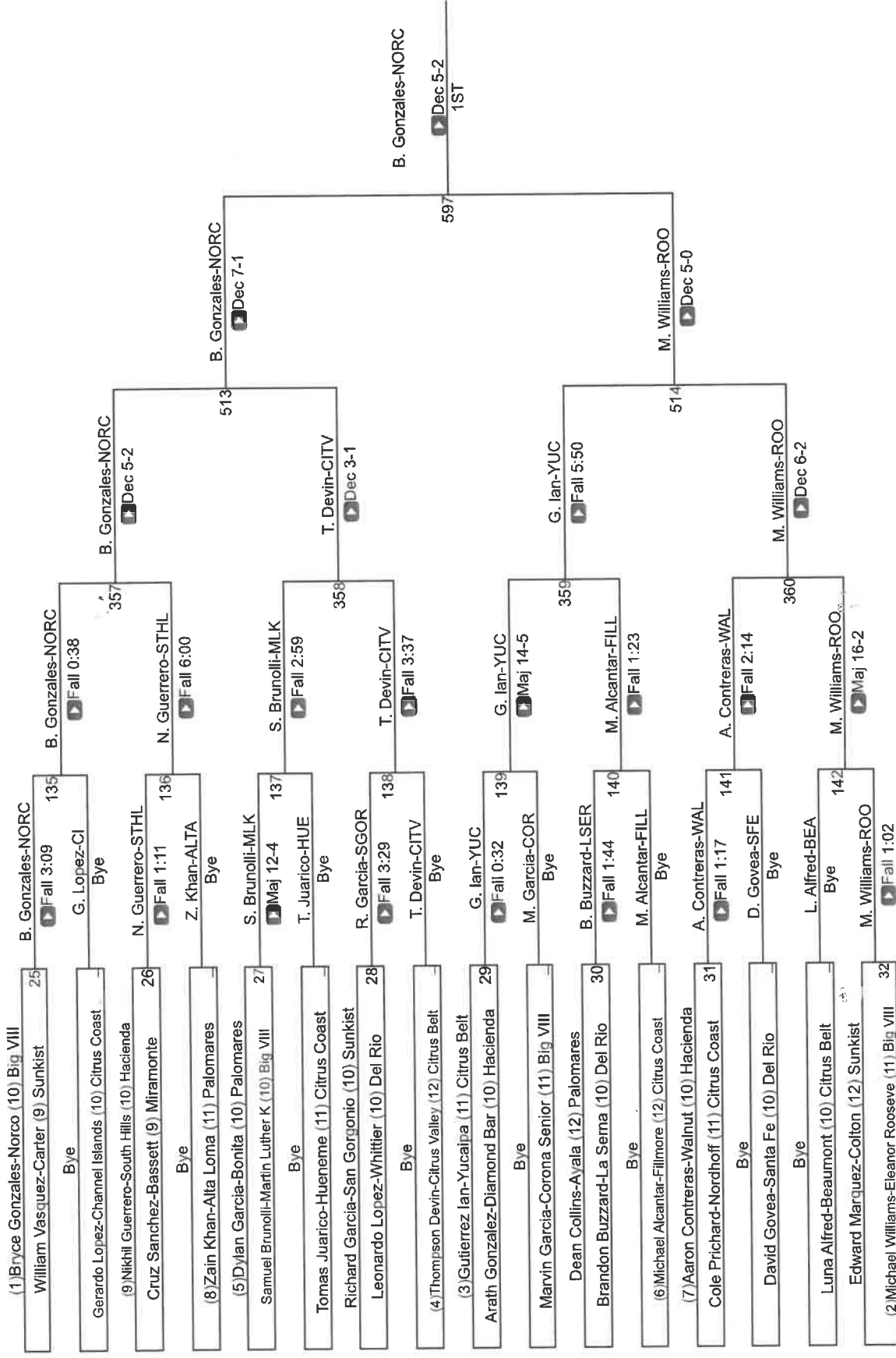

CIF Qualifier 126

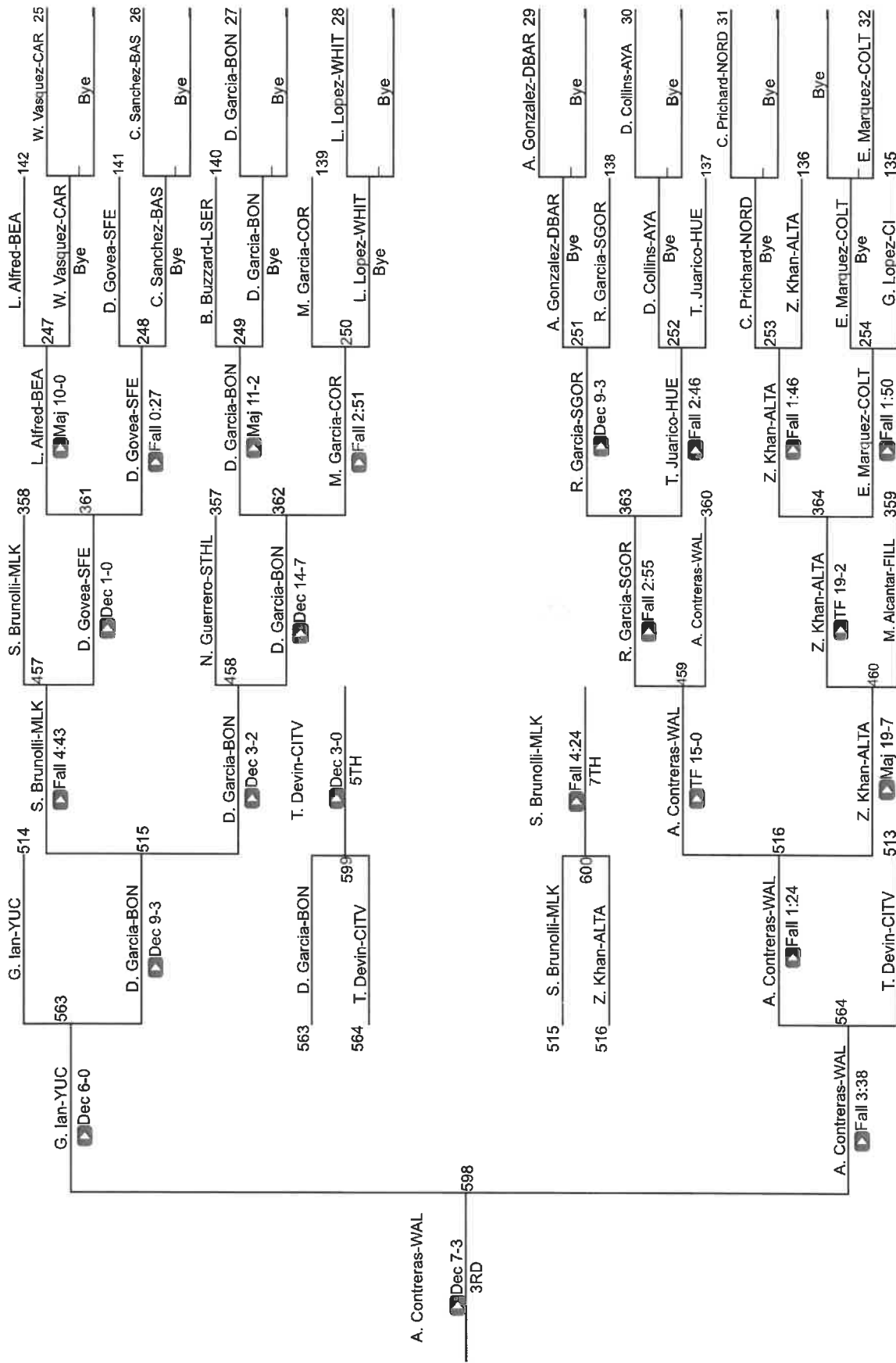

CIF SS Boys Individuals Central Div

CIF Qualifier 132

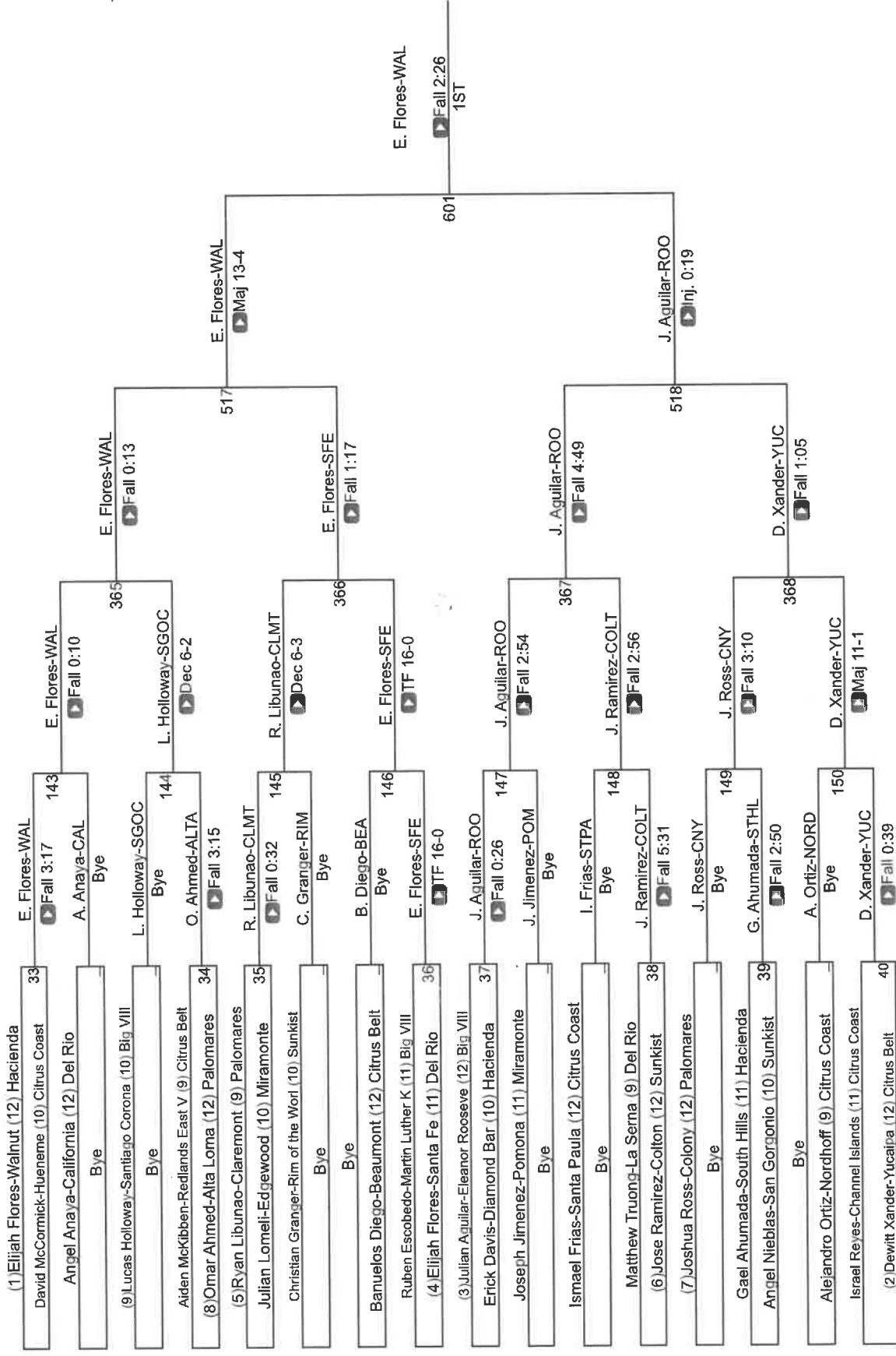

CIF SS Boys Individuals Central Div

CIF Qualifier 138

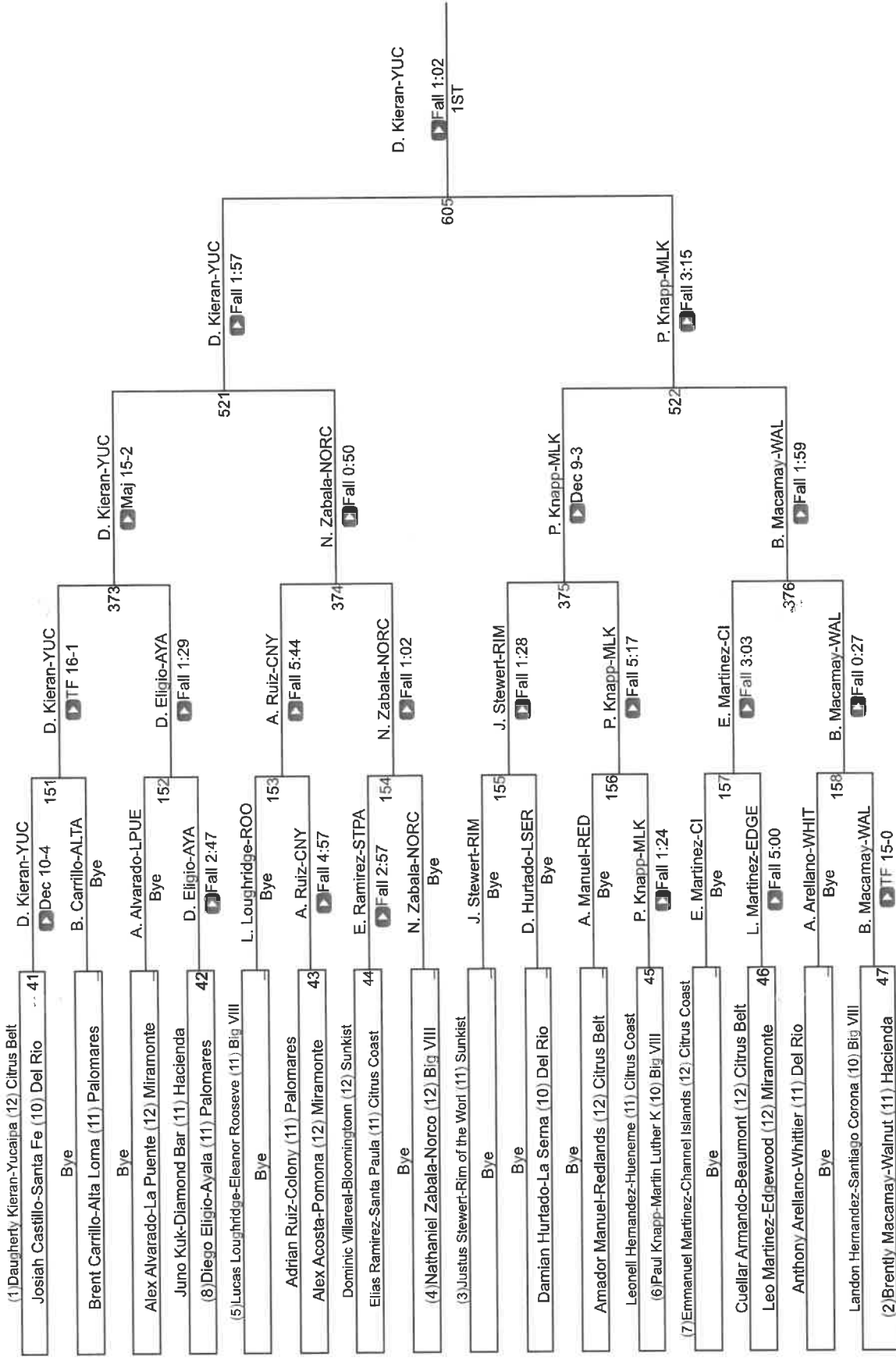

CIF Qualifier 138

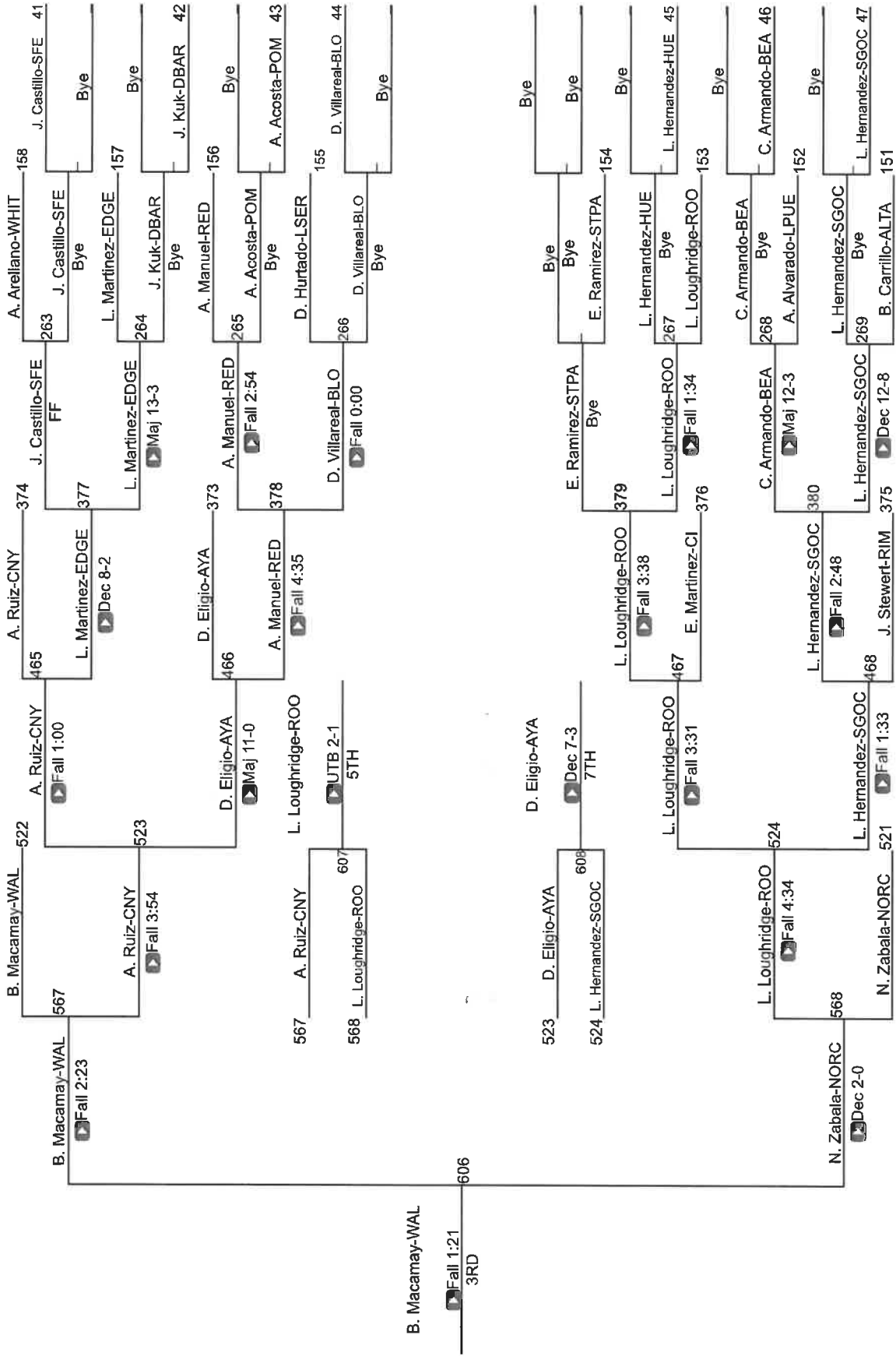

CIF SS Boys Individuals Central Div

CIF Qualifier 145

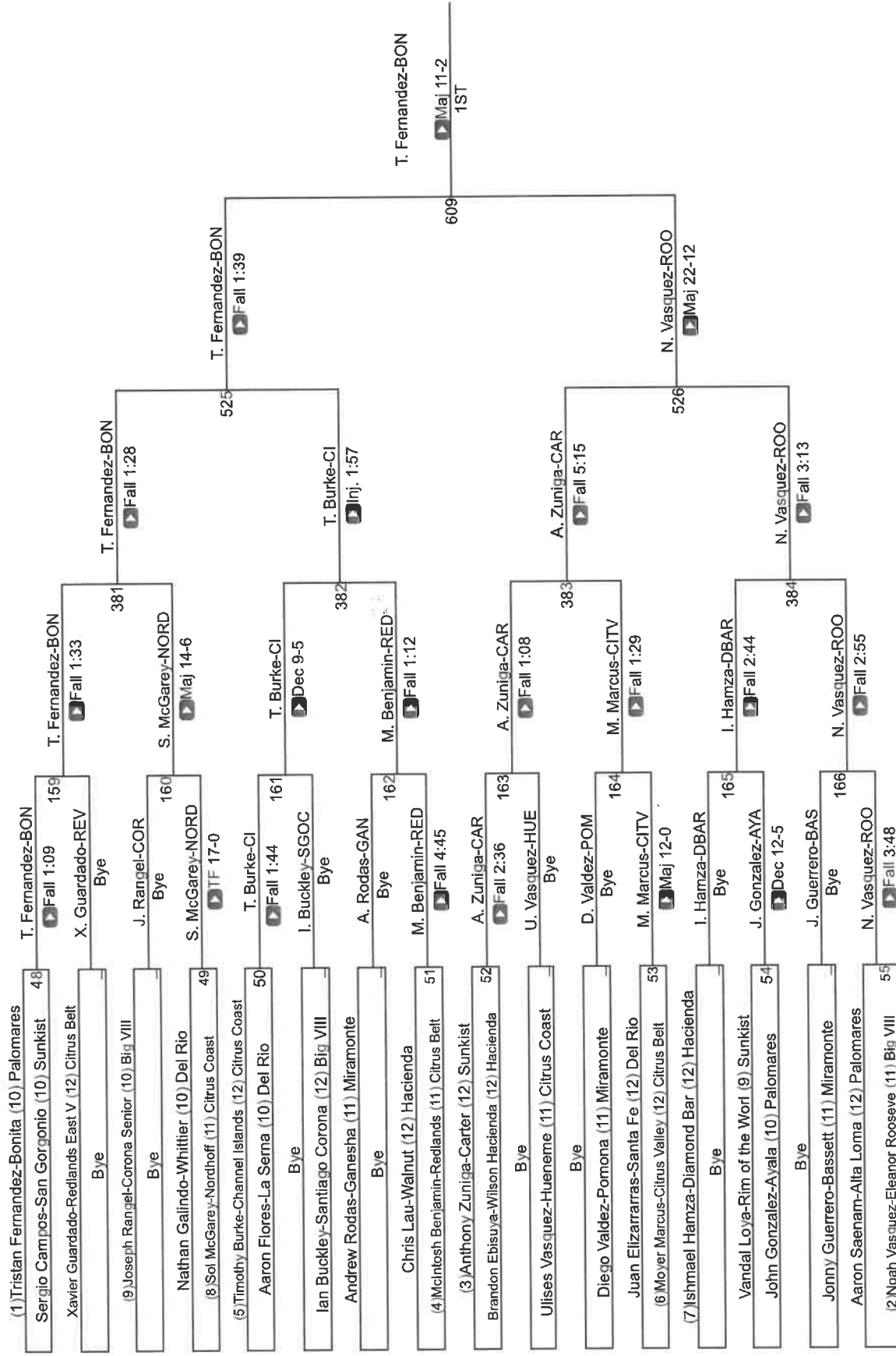

CIF Qualifier 145

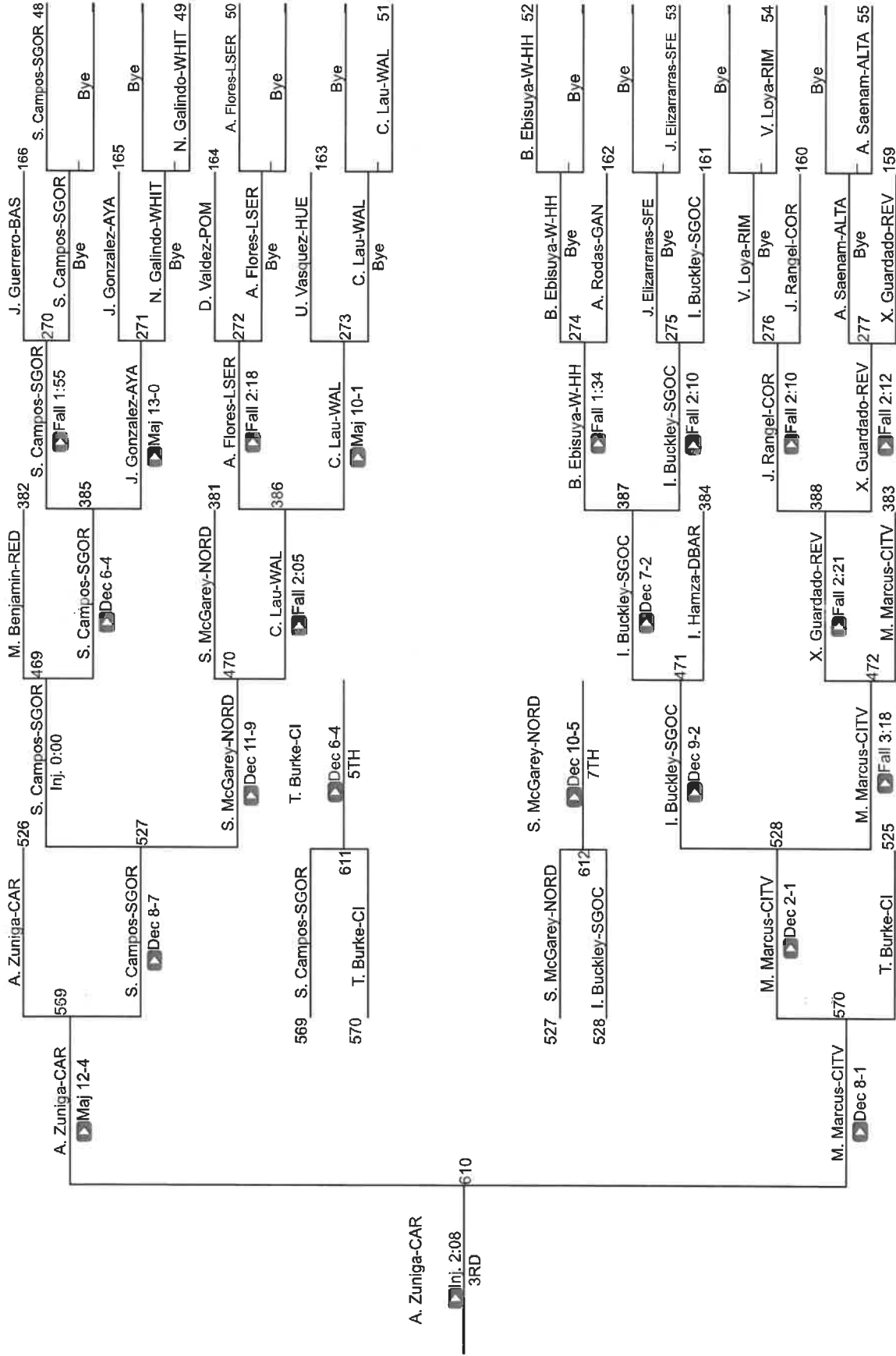

CIF SS Boys Individuals Central Div

CIF Qualifier 152

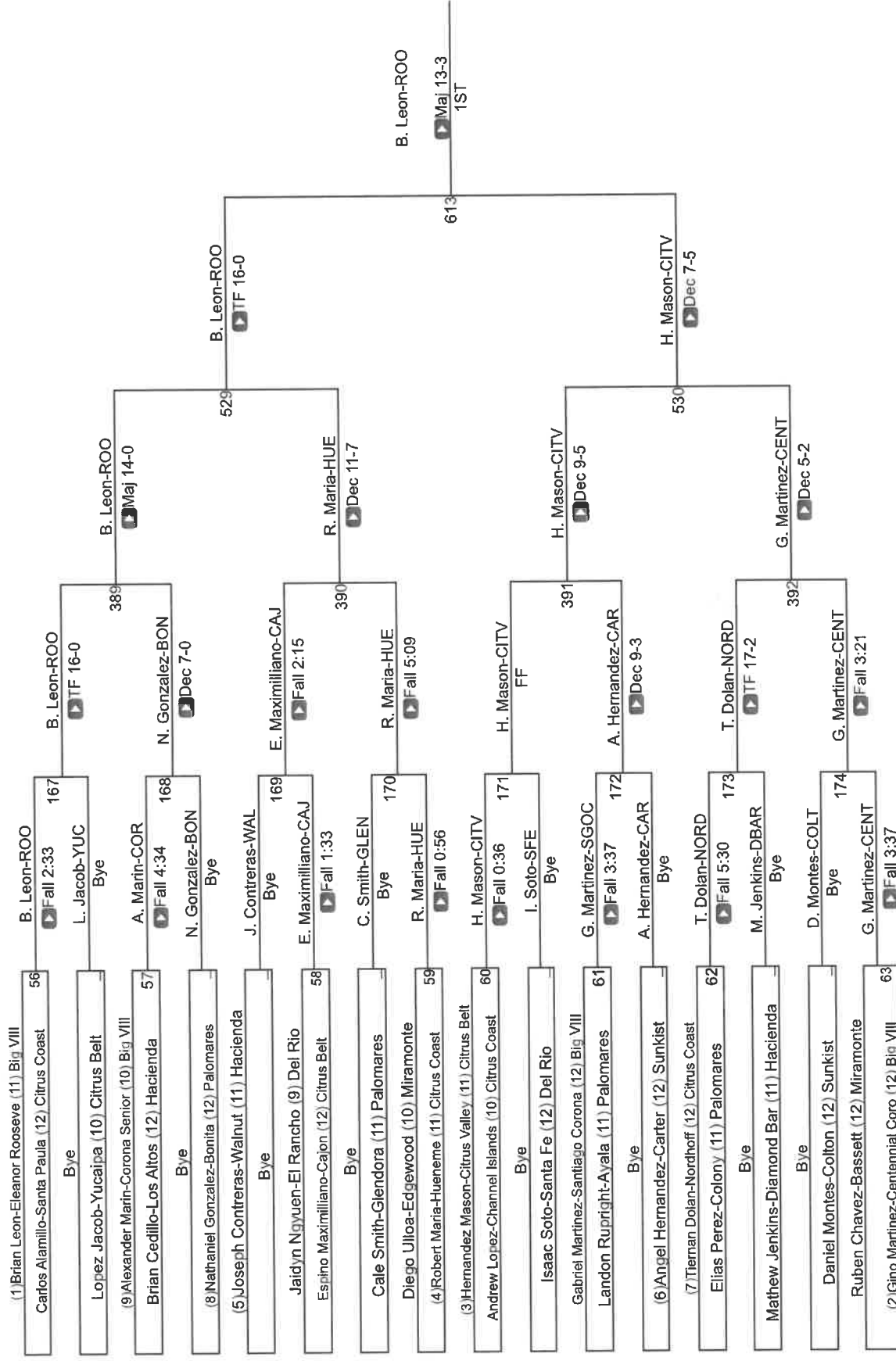

CIF Qualifier 152

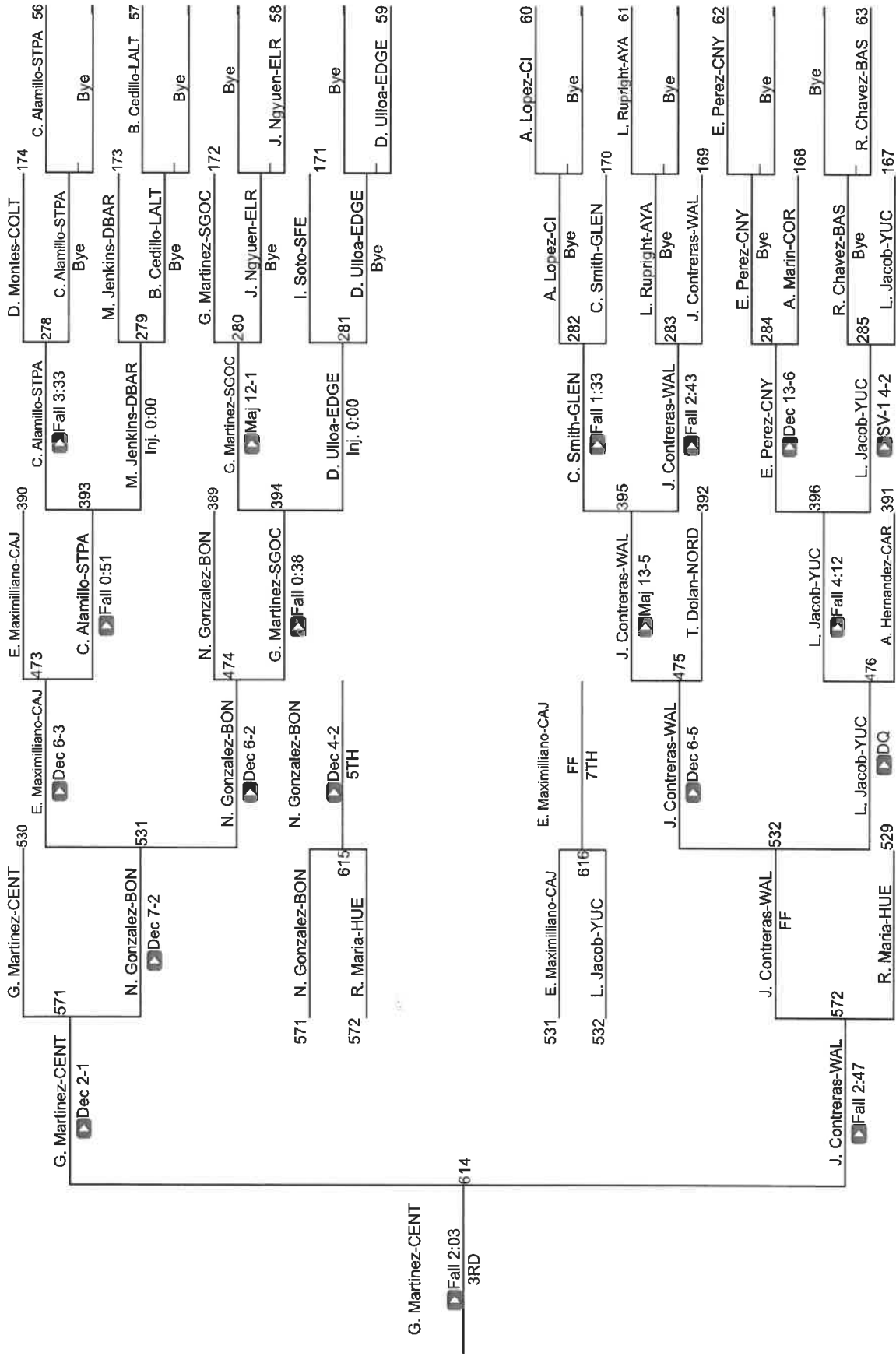

CIF Qualifier 160

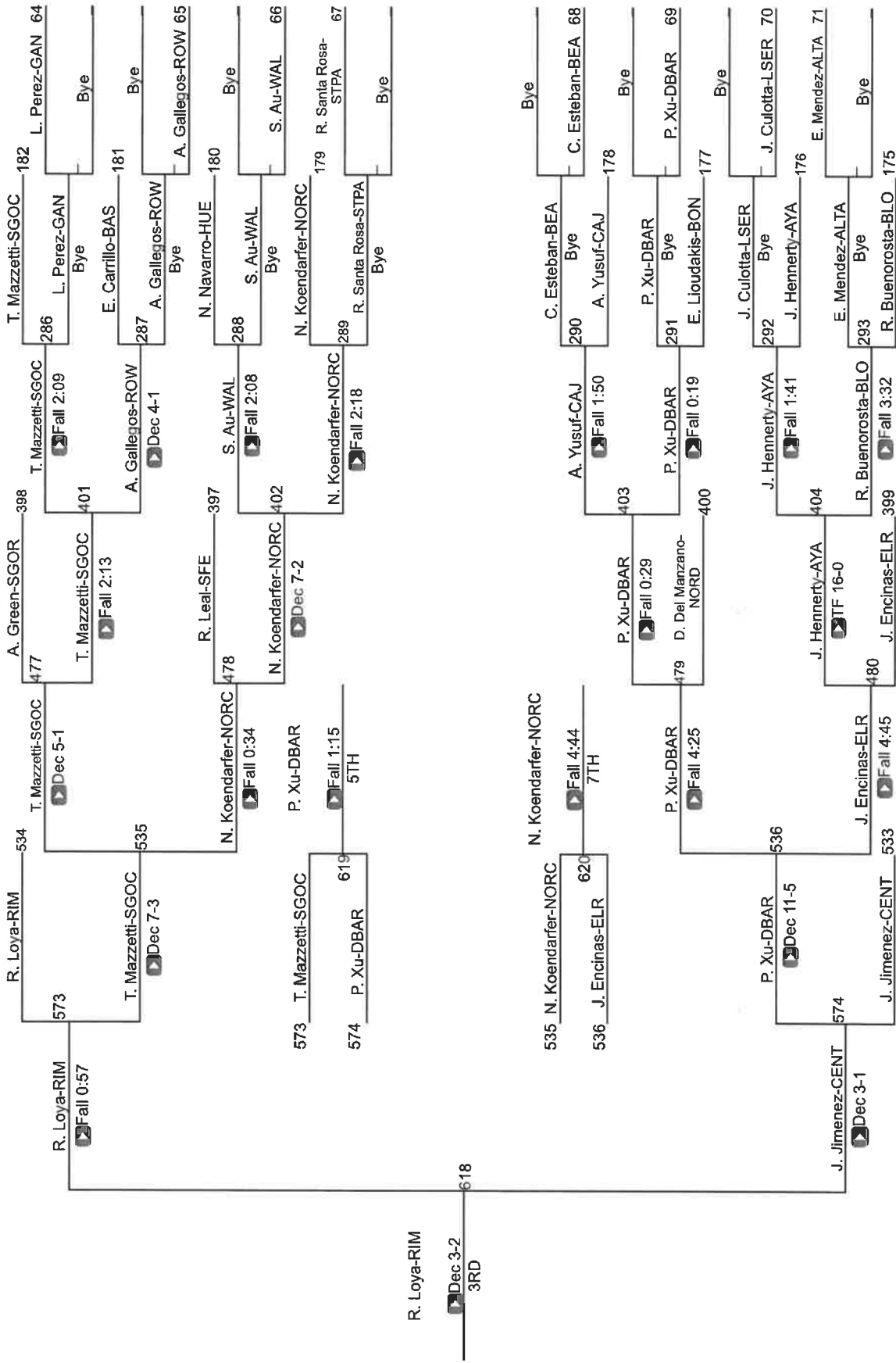

R. Loya-RIM

Dec 3-2
3RD

618

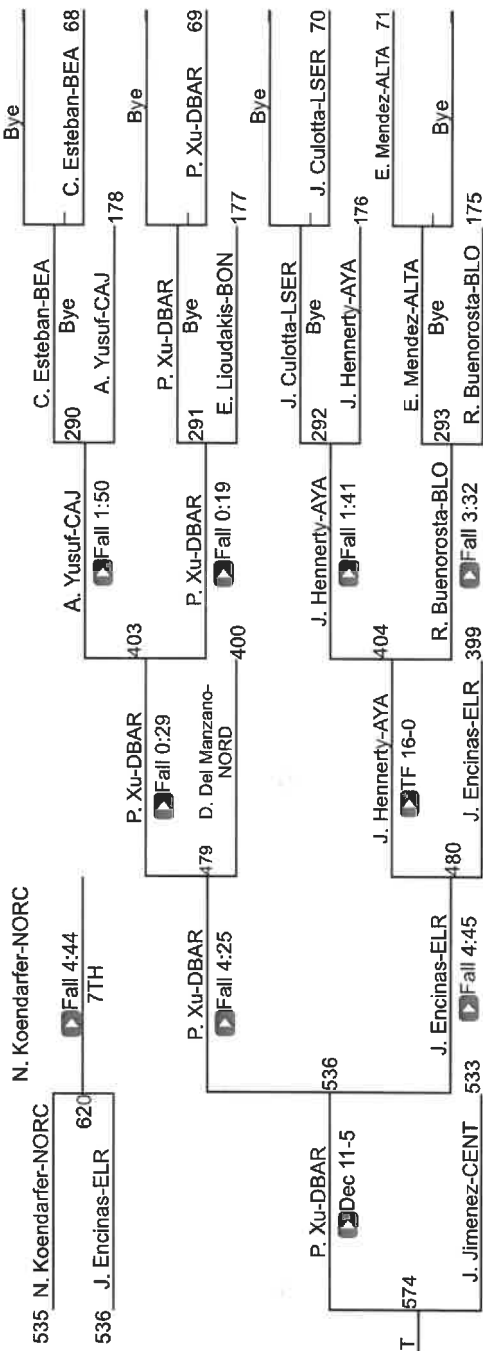
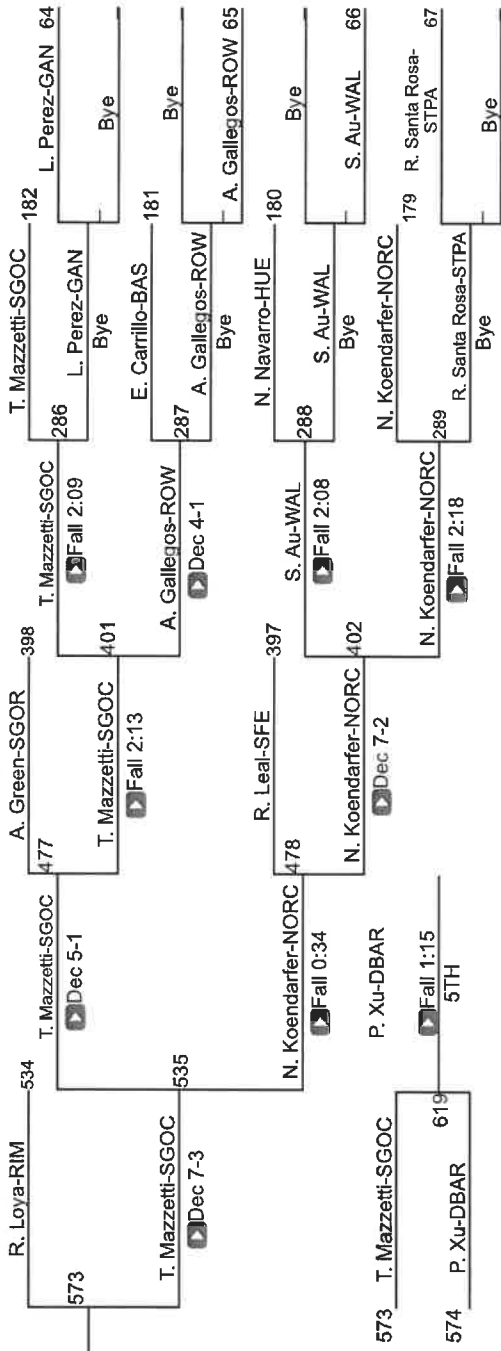

N. Koendarfer-NORC

535 N. Koendarfer-NORC

536 J. Encinas-ELR

Fall 4:44
7TH

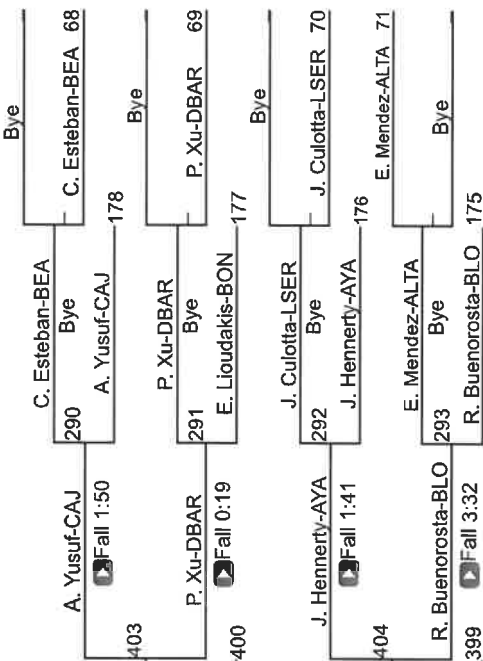
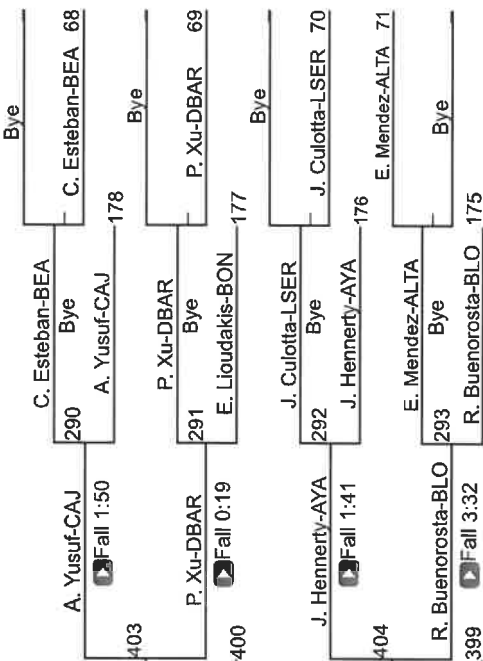
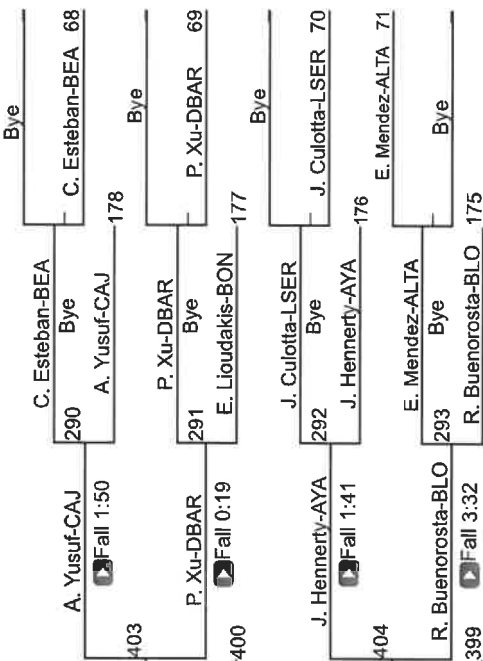

CIF SS Boys Individuals Central Div

CIF Qualifier 170

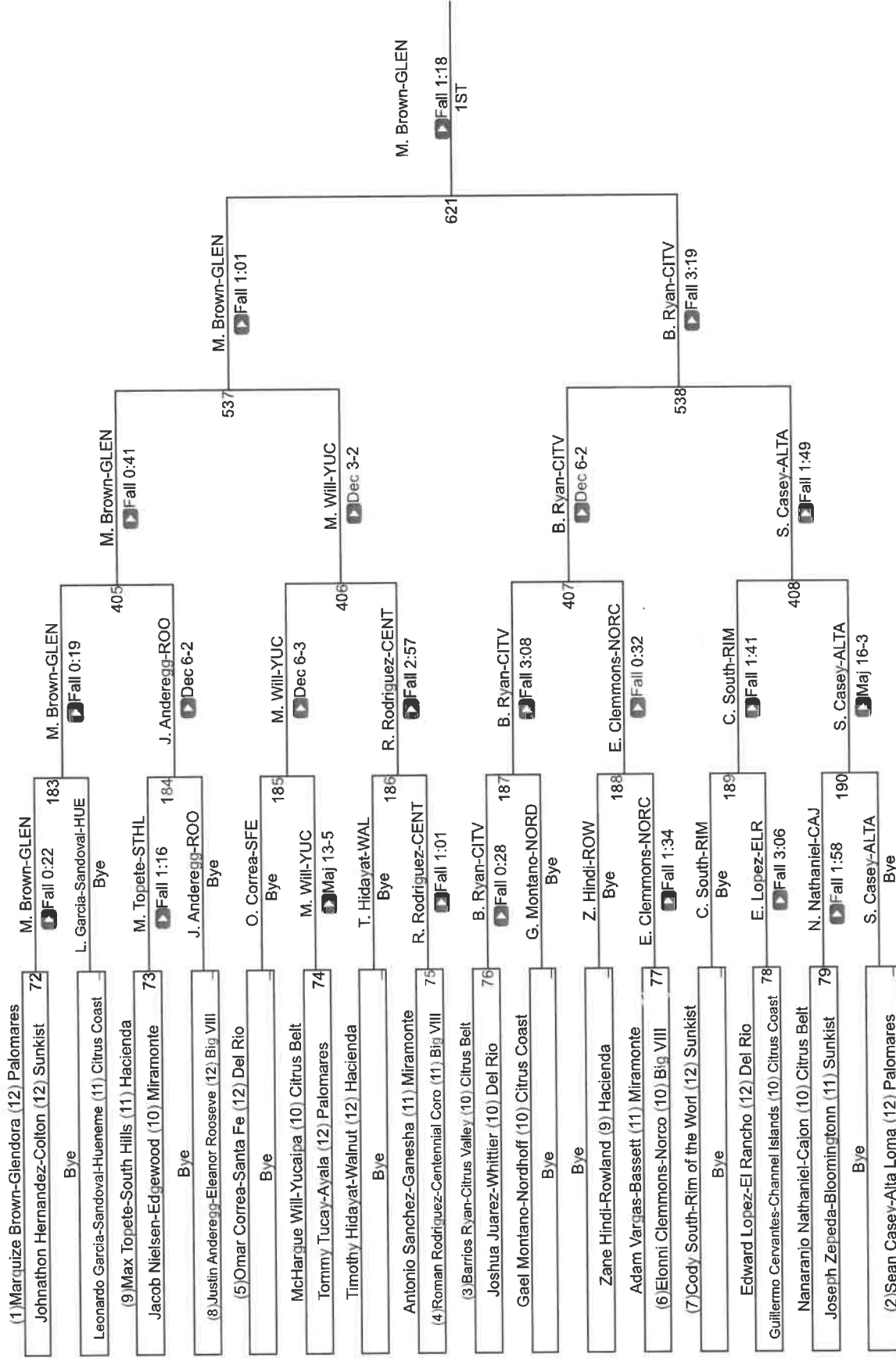

CIF Qualifier 170

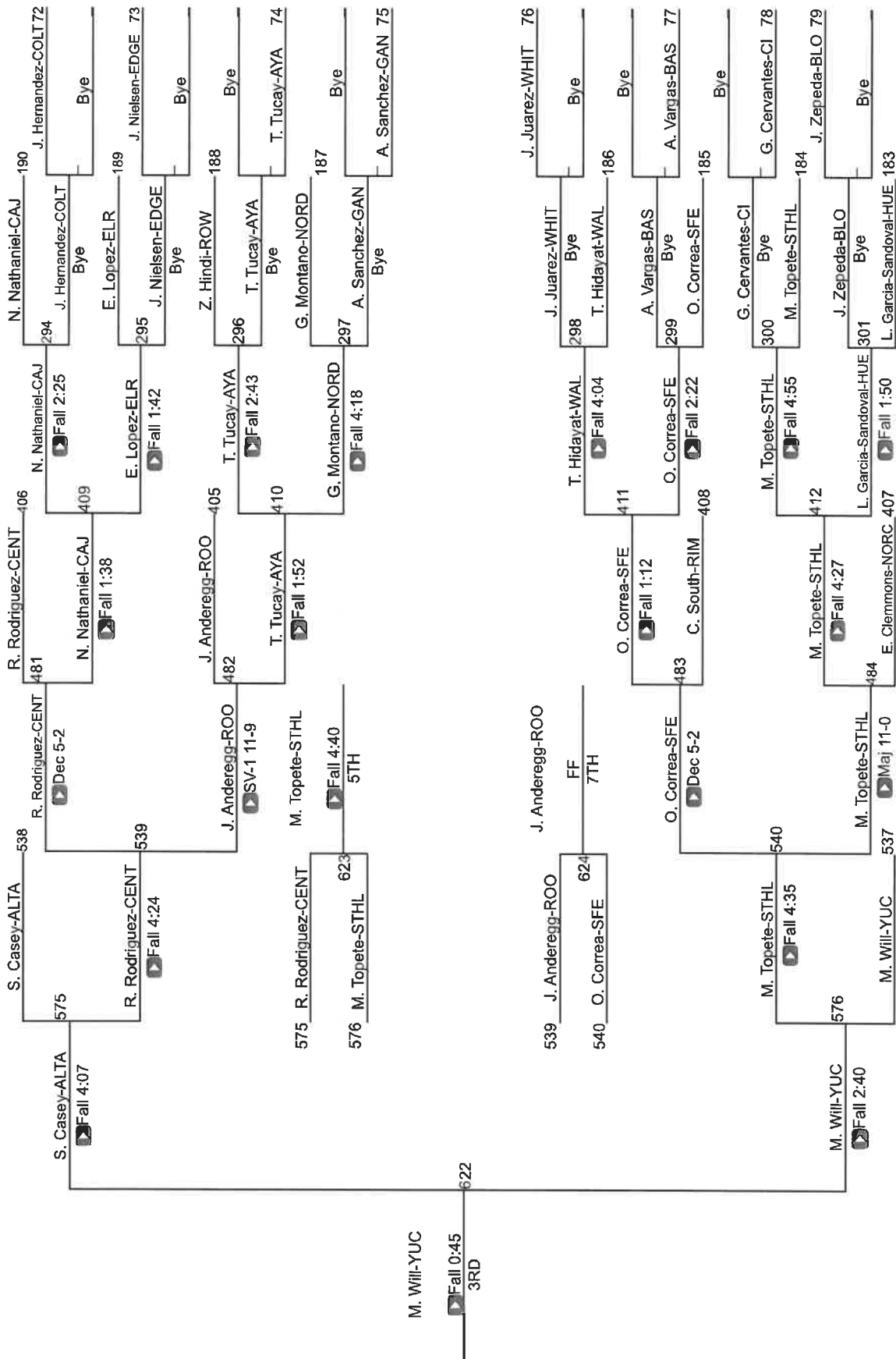

CIF SS Boys Individuals Central Div

CIF Qualifier 182

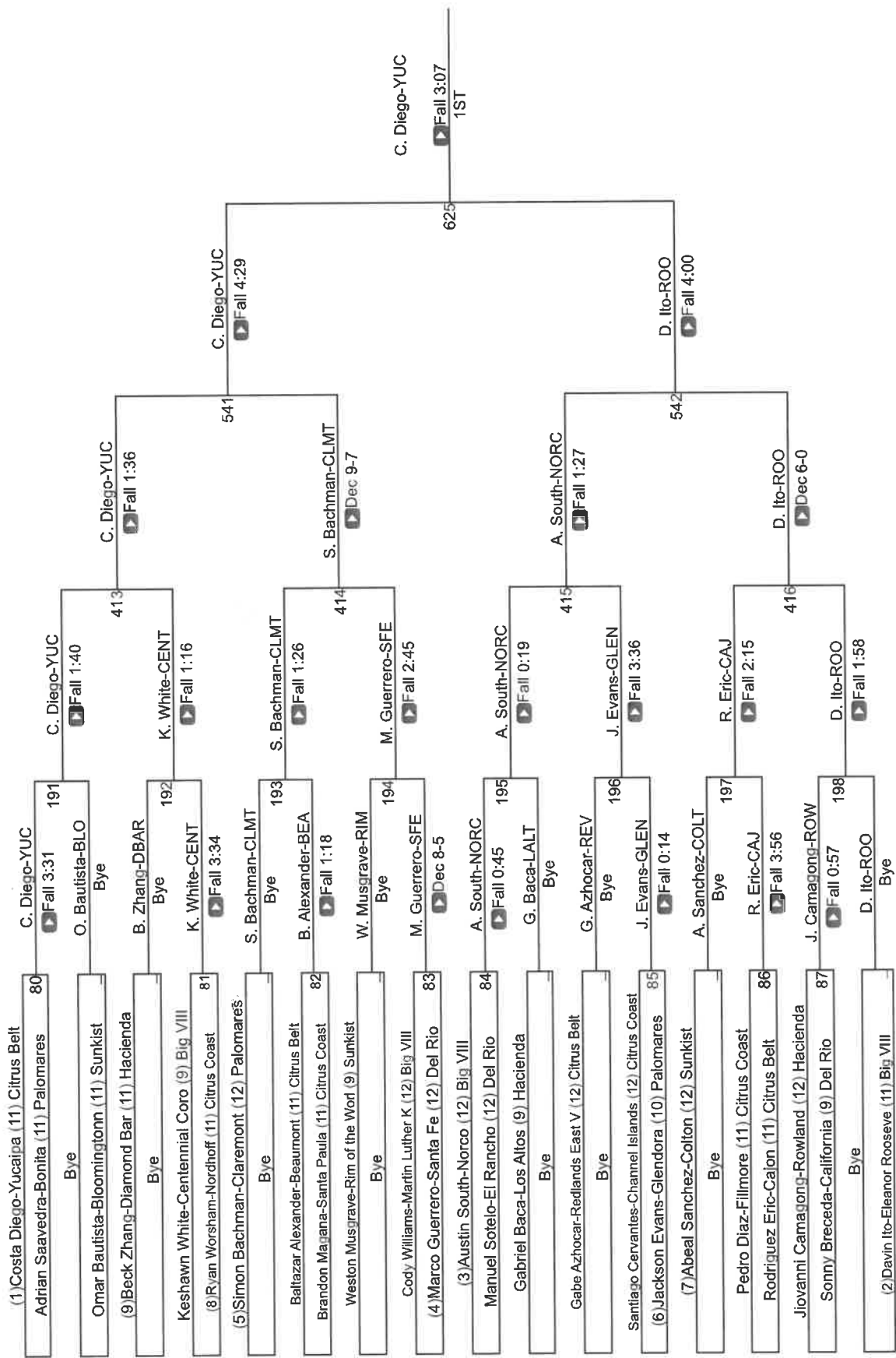

CIF SS Boys Individuals Central Div

CIF Qualifier 195

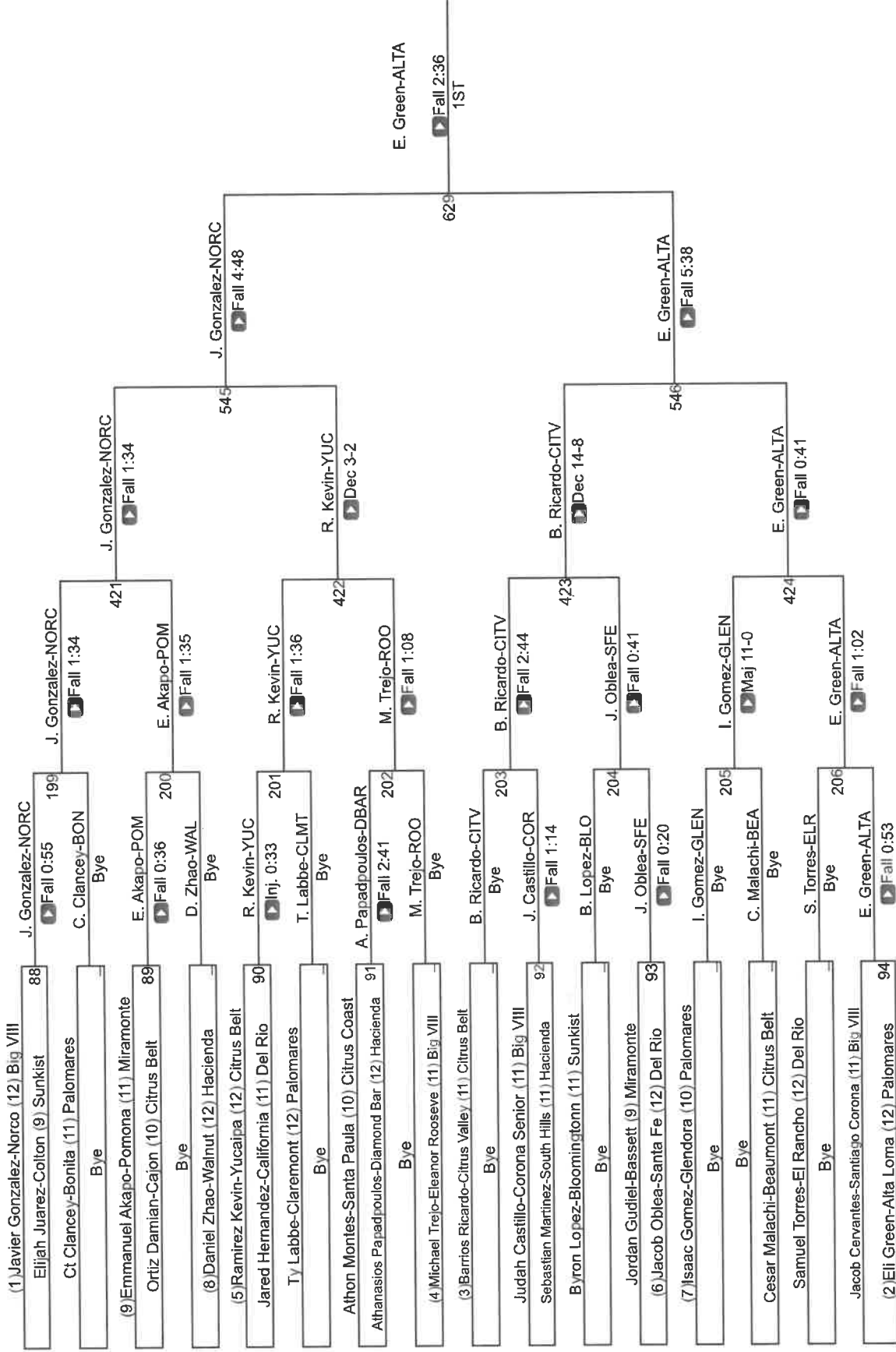

CIF Qualifier 195

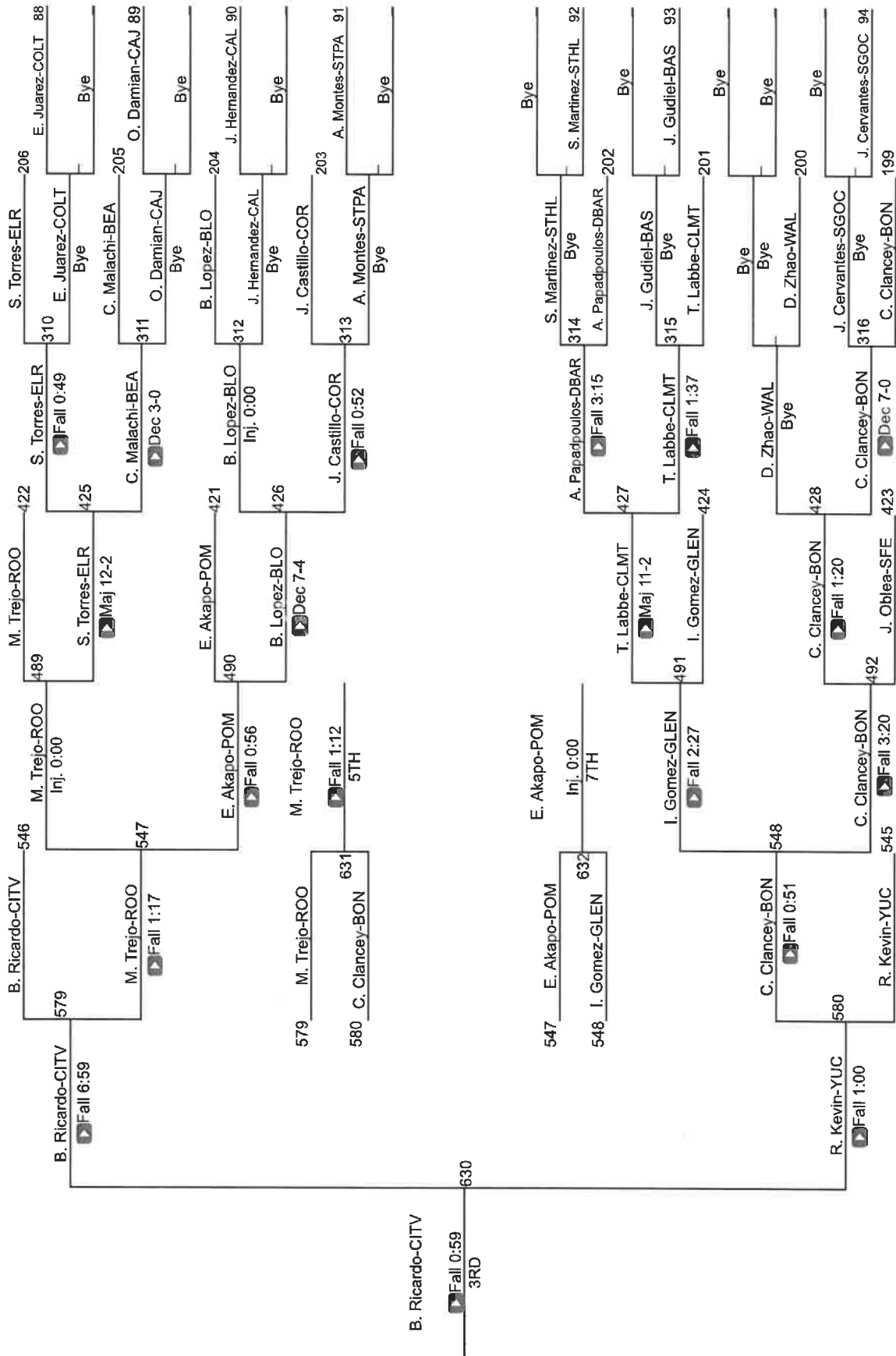

CIF SS Boys Individuals Central Div

CIF Qualifier 220



CIF Qualifier 220

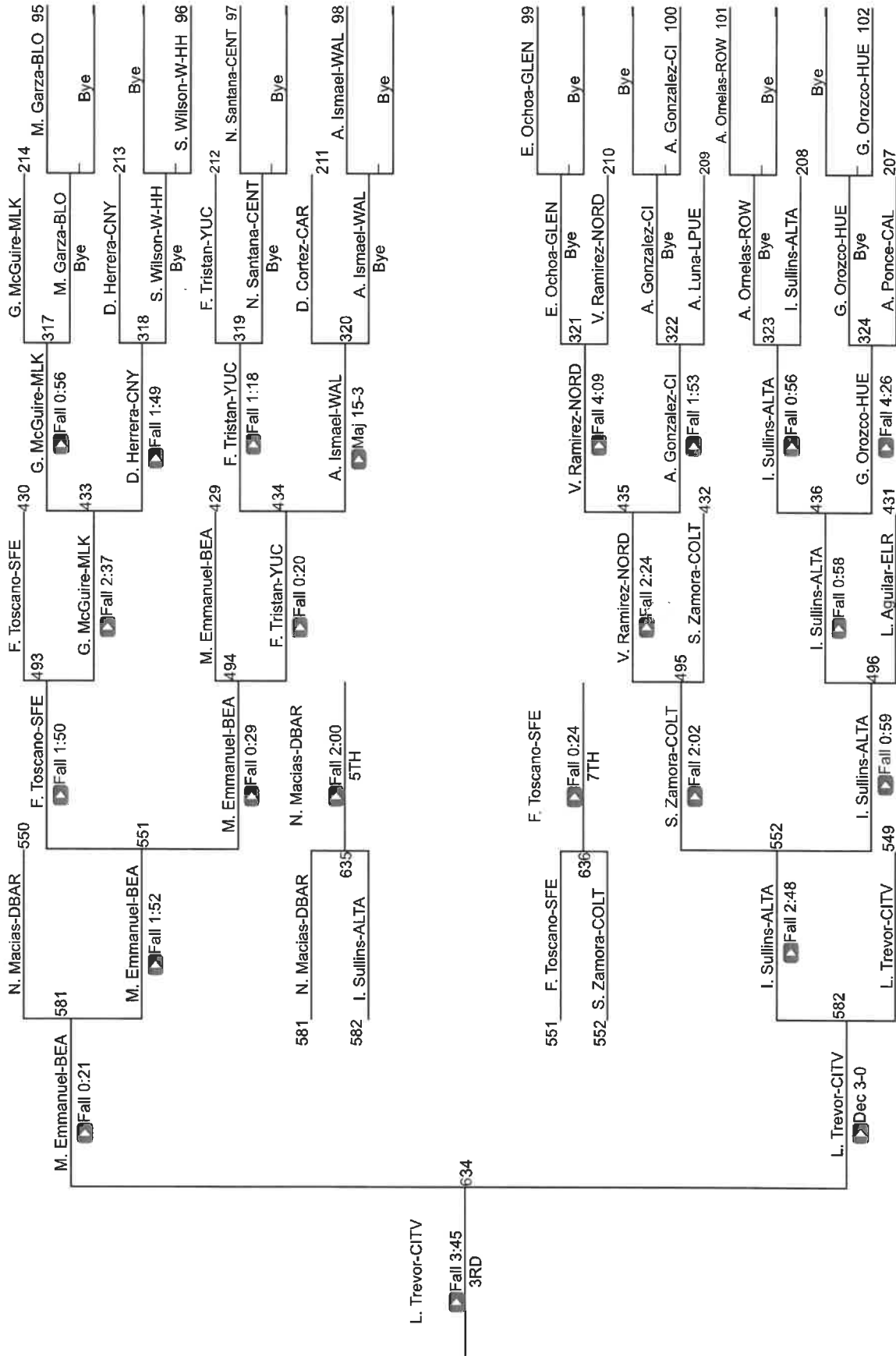

CIF SS Boys Individuals Central Div

CIF Qualifier 285

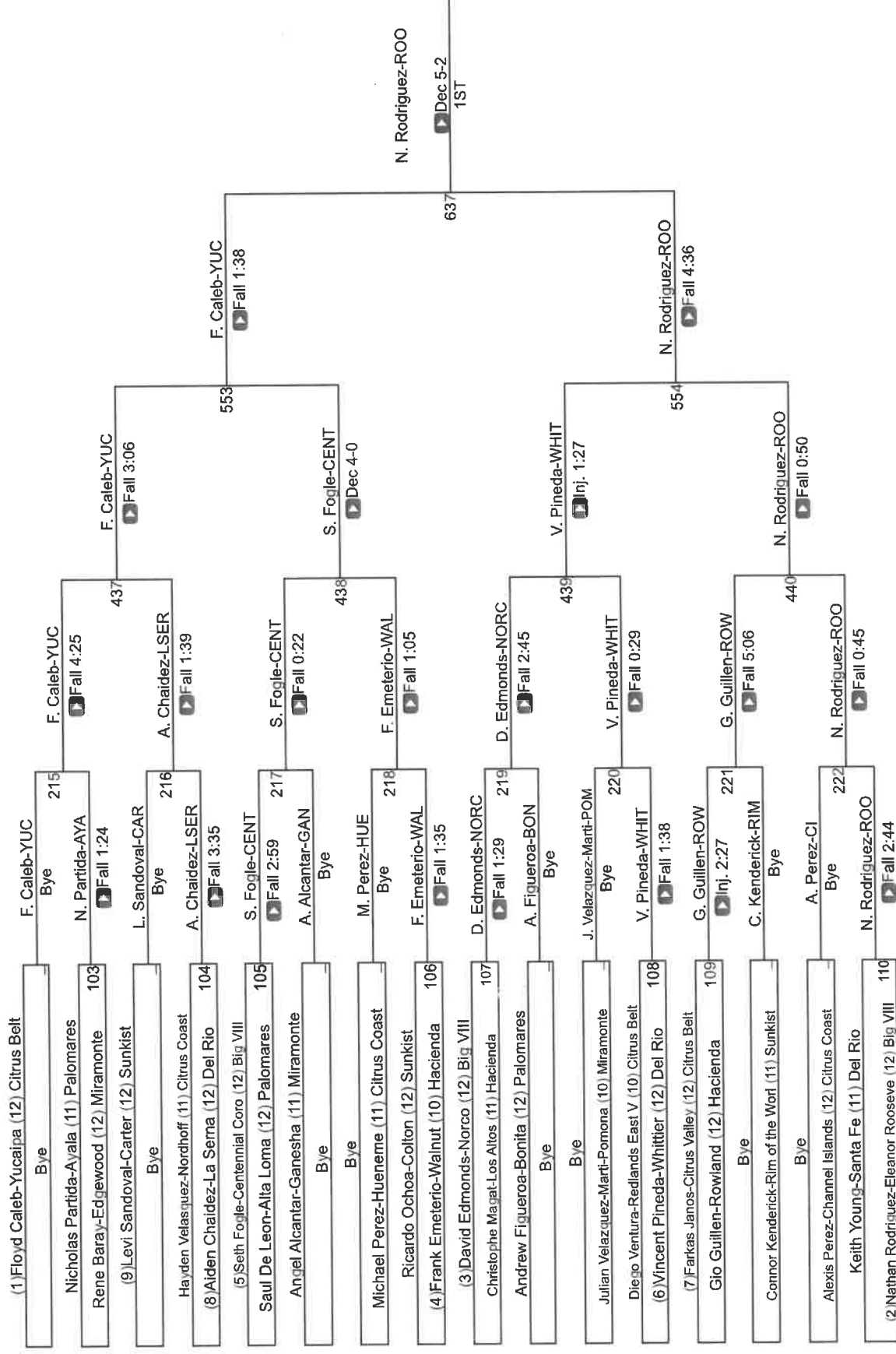

CIF Qualifier 285

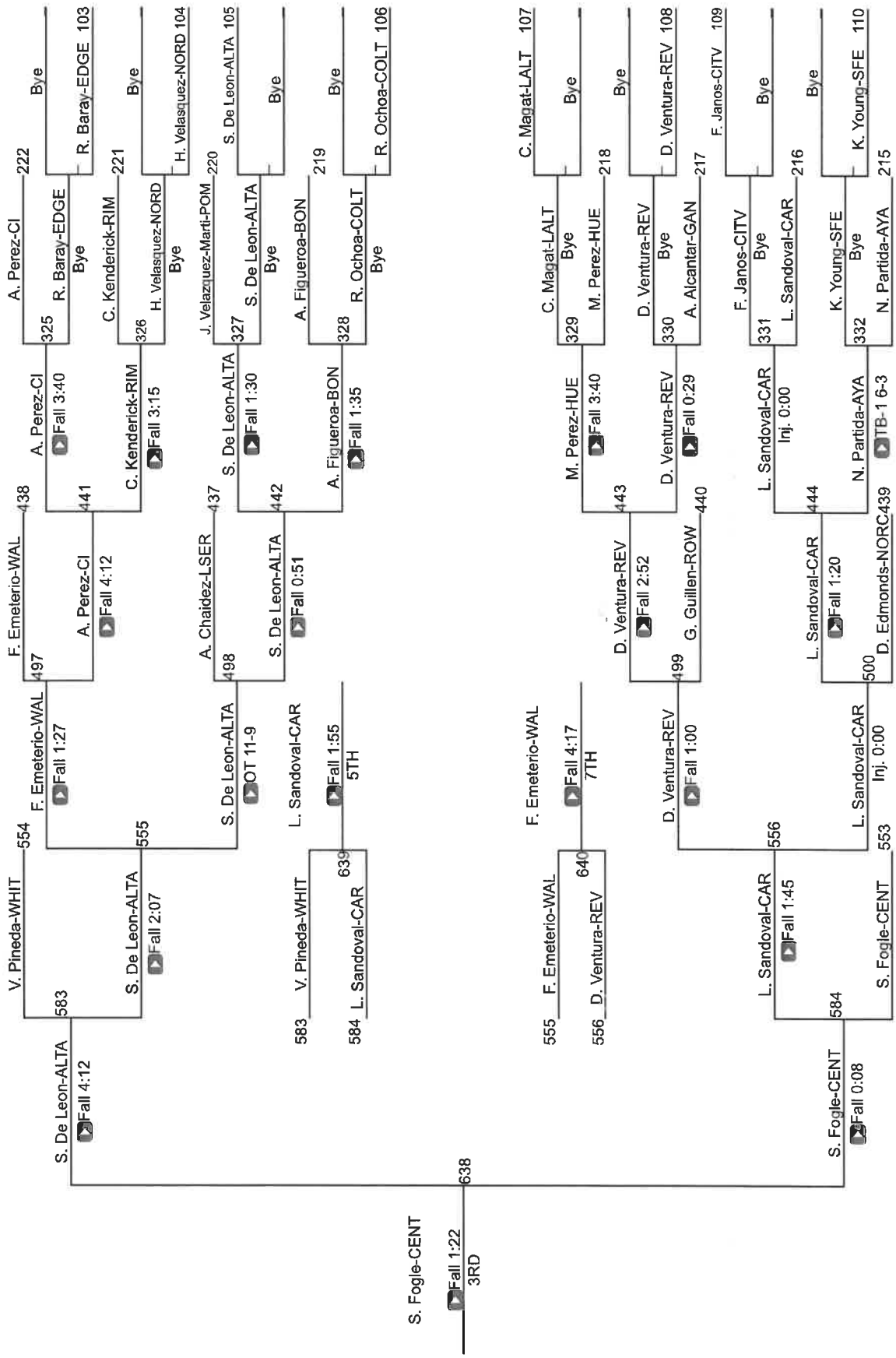

S. Fogle-CENT

Fall 1:22
3RD

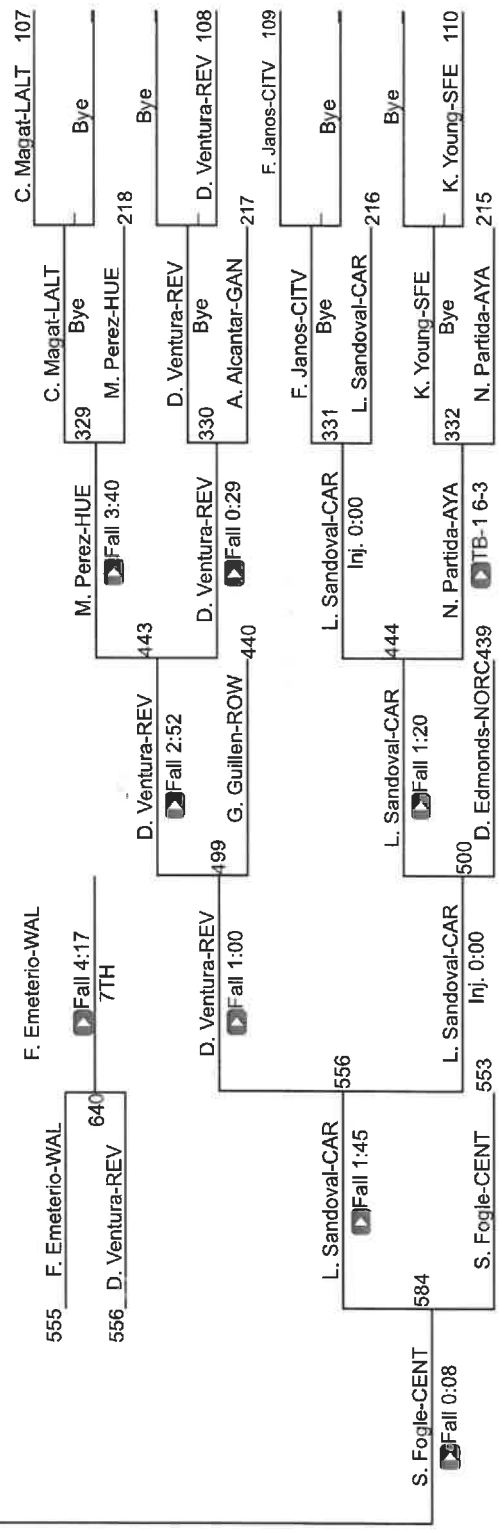

C. Magat-LALT 107

Bye

Bye

Bye

Bye

Bye

Bye

Bye

Bye

Bye

Bye

Bye

Bye

Bye

Bye

CIF SS Boys Individuals

Coastal Division

Westminster High School

February 10-11, 2023



Lower Weight MVP

Joseph Antonio
St John Bosco
145 Pounds

Upper Weight MVP

Mark Ayala
St John Bosco
195 Pounds

Placers

106 Pounds			152 Pounds			Team Score Final		
1st	Sean Willcox	St John Bosco	1st	Jacob Salcedo	Northview	1	St John Bosco	403.5
2nd	Marcus Tolentino	Northview	2nd	Yazir Tellez	St John Bosco	2	Northview	289
3rd	Jacob Dominguez	San Marcos	3rd	Evan Sepanlou	Quartz Hill	3	Chino	214
4th	Jonathan Madera	Chino	4th	Lucas Reza	Servite	4	Servite	156.5
5th	Francisco Espinosa	Dos Pueblos	5th	Hector Medina	Oxnard	5	San Dimas	99.5
6th	Auslin Dye	Santa Barbara	6th	Dominic Ochoa	Santa Margarita	6	Lutheran Orange	92
7th	Kamari Baldeomar	San Dimas	7th	Paul Gonzales	Godinez	7	Lancaster	91.5
8th	Sasha Kliegl	La Canada	8th	Anthony Perez	Ontario	8	San Marino	85.5
113 Pounds			160 Pounds			9	Quartz Hill	76.5
1st	Issac Torres	St John Bosco	1st	Nicco Ruiz	St John Bosco	10	Thousand Oaks	75
2nd	Nick Arellano	Northview	2nd	Julius Soria	Chino	11	Dos Pueblos	68.5
3rd	Caleb Valenzuela	Chino	3rd	Nicolas Pham	Westminster	12	Buena	66.5
4th	Jamie Serrato	Highland	4th	Seth Hoodye	San Dimas	13	Seegerstrom	64
5th	Michael Manzano	La Canada	5th	Lance Dunwoody	Lutheran Orange	14	Ventura	62.5
6th	Angel Estrade	San Marcos	6th	Edward Asiryan	Hoover	15	Santa Barbara	60.5
7th	Jayden Tate	Ventura	7th	Saul Lopez	Littlerock	16	Westminster	59.5
8th	Frankie Brickey	West Covina	8th	Tanner Cardenas	Thousand Oaks	17	La Canada	58.5
120 Pounds			170 Pounds			18	Rio Mesa	51
1st	Nathan Carrillo	St John Bosco	1st	Nathan Cruz	Northview	19	Highland	50
2nd	Jovanni Evangelista	Northview	2nd	Julian Barajas	St John Bosco	20	San Marcos	49
3rd	Rylan Pedroza	Buena	3rd	Michael Alvarez	Mater Dei	21	Oxnard	45.5
4th	David Martinez	Servite	4th	Jon Miller	Buena	22	Santa Margarita	43
5th	Cody Pearce	Dos Pueblos	5th	Joseph Dervartanian	Lutheran Orange	23	JSerra	41
6th	Noah Halstead	Lancaster	6th	William Meija	Littlerock	24	Garden Grove	40.5
7th	Daniel Villapando	Chino	7th	Valentin Soto	Chaffey	25	Westlake	36
8th	Aidan Vazquez	Westlake	8th	Christian Tucker-Martin	Lancaster	26	Chaffey	35
126 Pounds			182 Pounds			27	Burbank	34
1st	Zaydrein Hernandez	St John Bosco	1st	Sonny Acuna	Northview	28	Littlerock	33
2nd	Edvin Obregon	Lancaster	2nd	Michael Vassalle	Chino	29	Montclair	32
3rd	Nathan Cauwel	Chino	3rd	Michael Morales	St John Bosco	30	Mater Dei	27
4th	Taylor Tan	San Marino	4th	Arthur Tyler McCown	Servite	31	Hoover	24
5th	Rene Cisneros	Northview	5th	Abel Gonzalez	Seegerstrom	32	Katella	22
6th	Alex Newman	Servite	6th	Angel Correa	Lancaster	33	Charter Oak	20
7th	Artemis Shmuel	Seegerstrom	7th	James Rocha	Thousand Oaks	34	Calabasas	19
8th	Cervando Tapia	Oxnard	8th	Matthew Homan	Buena	35	Godinez	19
132 Pounds			195 Pounds			36	Newbury Park	19
1st	Mario Sandoval	Northview	1st	Mark Ayala	St John Bosco	37	West Covina	19
2nd	Tigran Greyan	St John Bosco	2nd	Robert Svitek	Thousand Oaks	38	Eastside	17
3rd	Jeremy Ortiz	San Dimas	3rd	Nathan Blanco	Chino	39	Covina	16
4th	Nathaniel Gonzalez	Chino	4th	Aiden Pacheco	Northview	40	Monrovia	16
5th	Calen Reyna	Servite	5th	Julian Solis	San Marino	41	Pacifica Oxnard	16
6th	William Ramos	Thousand Oaks	6th	Joshua Godinez	Oxnard	42	Don Lugo	14.5
7th	Peyton McCanna	Quartz Hill	7th	Adam Ruiz	La Canada	43	Ontario	13.5
8th	Adrian Hadis	Santa Margarita	8th	Talanoa Ili	Lutheran Orange	44	Agoura	13
138 Pounds			220 Pounds			45	Knight	9
1st	Grigor Cholakyan	St John Bosco	1st	Nicholas Sahakian	St John Bosco	46	Village Christian	7
2nd	Ryder Yoshitake	San Marino	2nd	Luke Webb	JSerra	47	Diamond Ranch	6
3rd	Viviano Gutierrez	Northview	3rd	Elijah Tehe	Montclair	48	Palmdale	6
4th	Jordan Mallo	Chino	4th	Tusitala Ili	Lutheran Orange	49	Antelope Valley	5
5th	Daniel Rundle	Ventura	5th	Jayden Baer	Quartz Hill			
6th	Vahagn Ghazaryan	Burbank	6th	Edwin Hopkins	Westminster			
7th	Peter Thompson	Lutheran Orange	7th	Daniel Garibay	Chino			
8th	Matthew Siegel	Thousand Oaks	8th	David Perez	Rio Mesa			
145 Pounds			285 Pounds					
1st	Joseph Antonio	St John Bosco	1st	Anthony Garcia	Rio Mesa			
2nd	Joshua Valdez	Servite	2nd	Oskar Madrigal	Servite			
3rd	Mikel David Uyemura	San Marino	3rd	Nathan Boyce	St John Bosco			
4th	Niko Proft	Santa Barbara	4th	Dylan Avila	Seegerstrom			
5th	Maxwell Hoang	Garden Grove	5th	Matthew Caram	Quartz Hill			
6th	Ethan Boos	Lancaster	6th	Hector Jimenez	Charter Oak			
7th	Kilian Hannegan	JSerra	7th	Jason Freeman	Chaffey			
8th	Georgii Guledani	Calabasas	8th	Ivan Medina	Dos Pueblos			

CIF SS Boys Individuals Coastal Div

CIF Qualifier 106

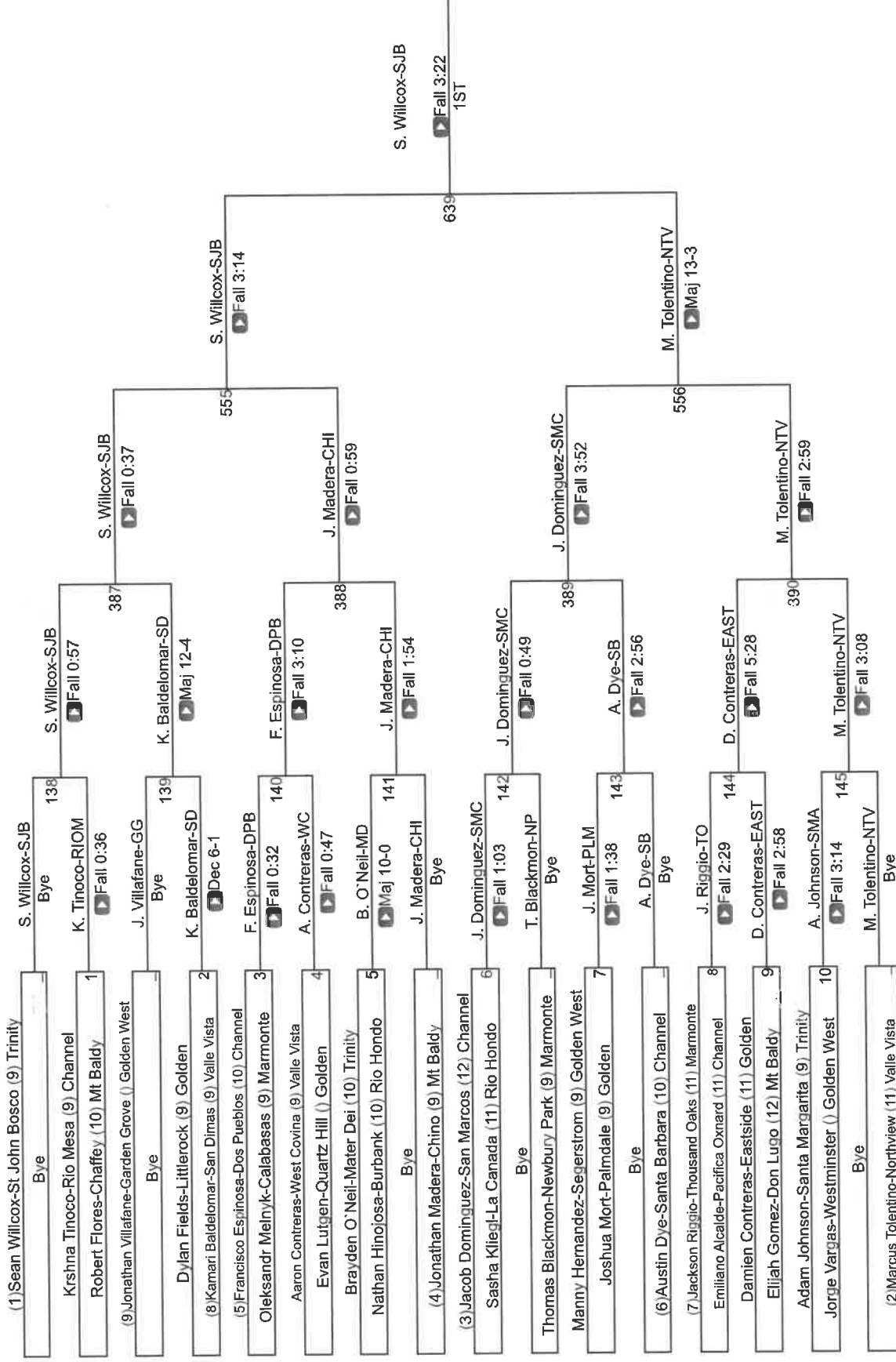

CIF SS Boys Individuals Coastal Div

CIF Qualifier 120

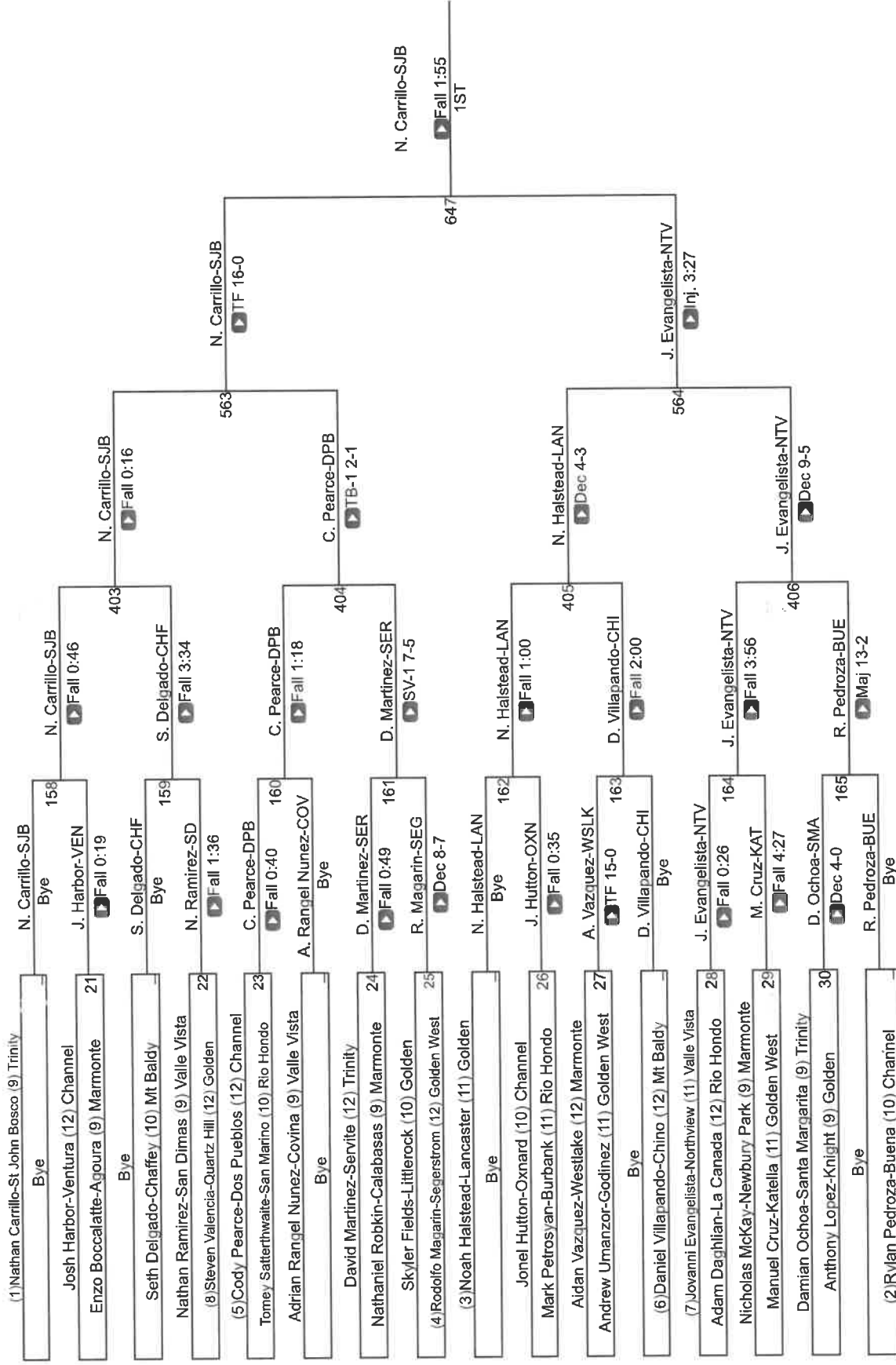

CIF SS Boys Individuals Coastal Div

CIF Qualifier 126

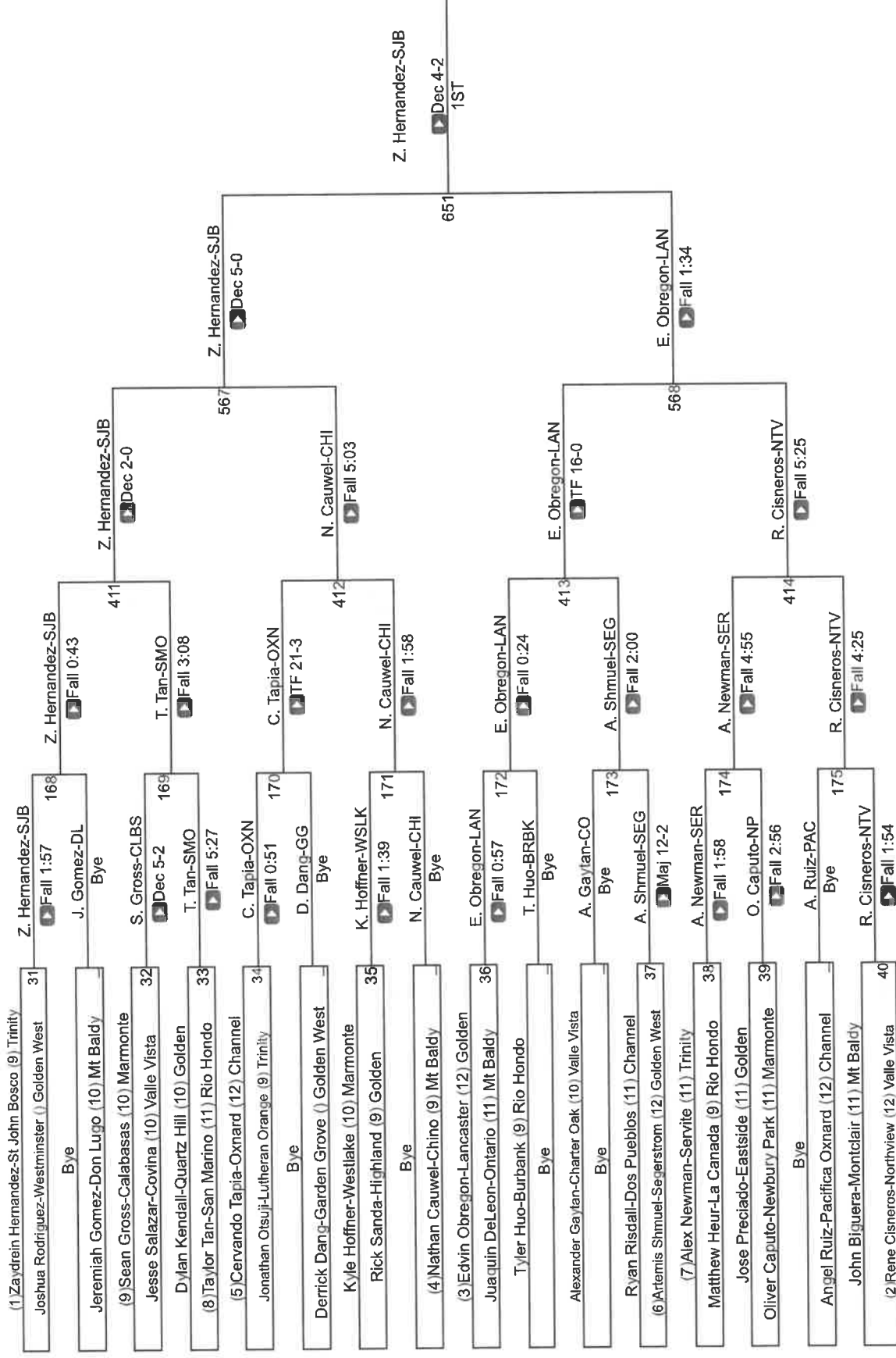

CIF Qualifier 126

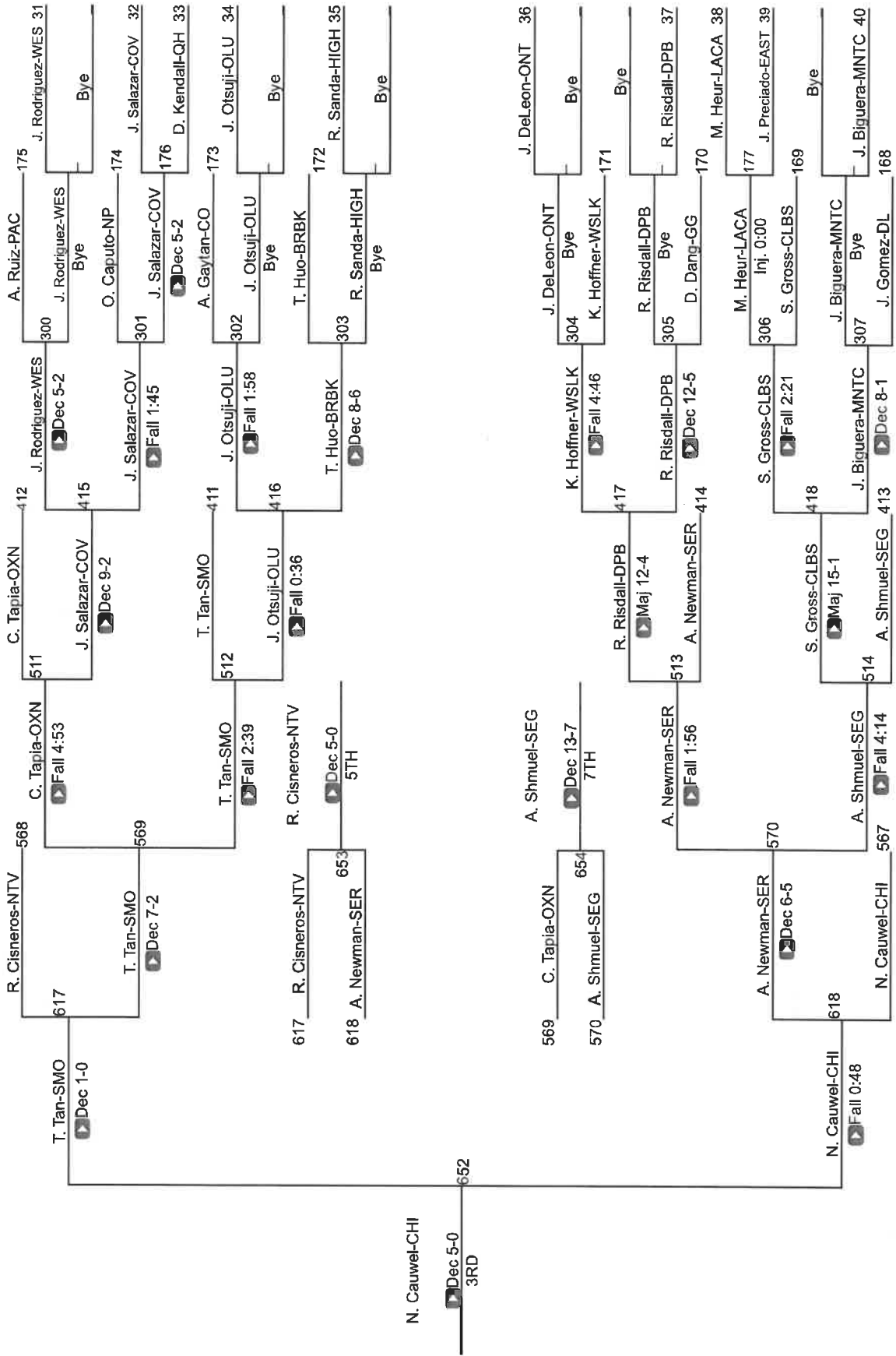

CIF SS Boys Individuals Coastal Div

CIF Qualifier 132

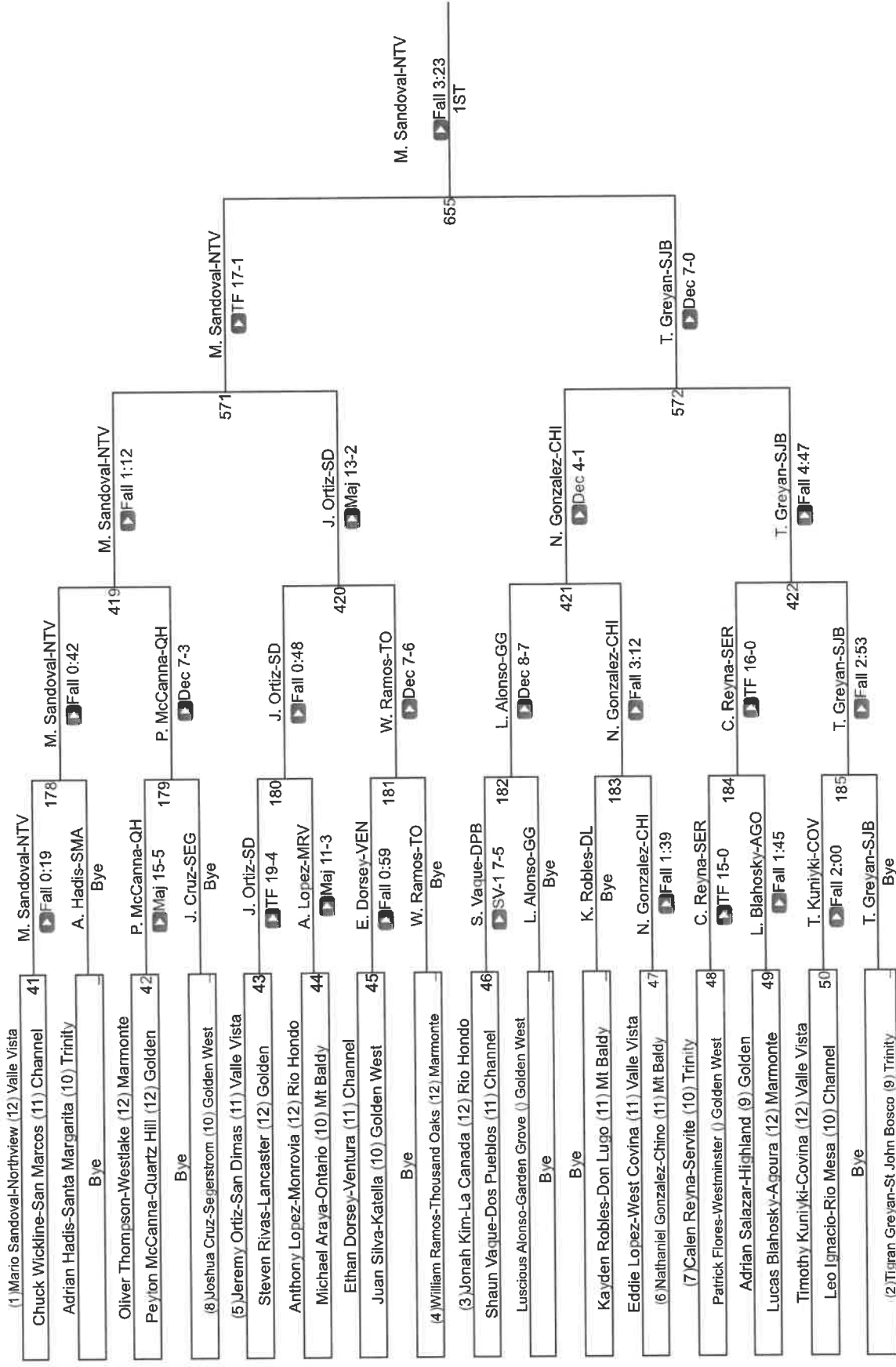

CIF SS Boys Individuals Coastal Div

CIF Qualifier 145

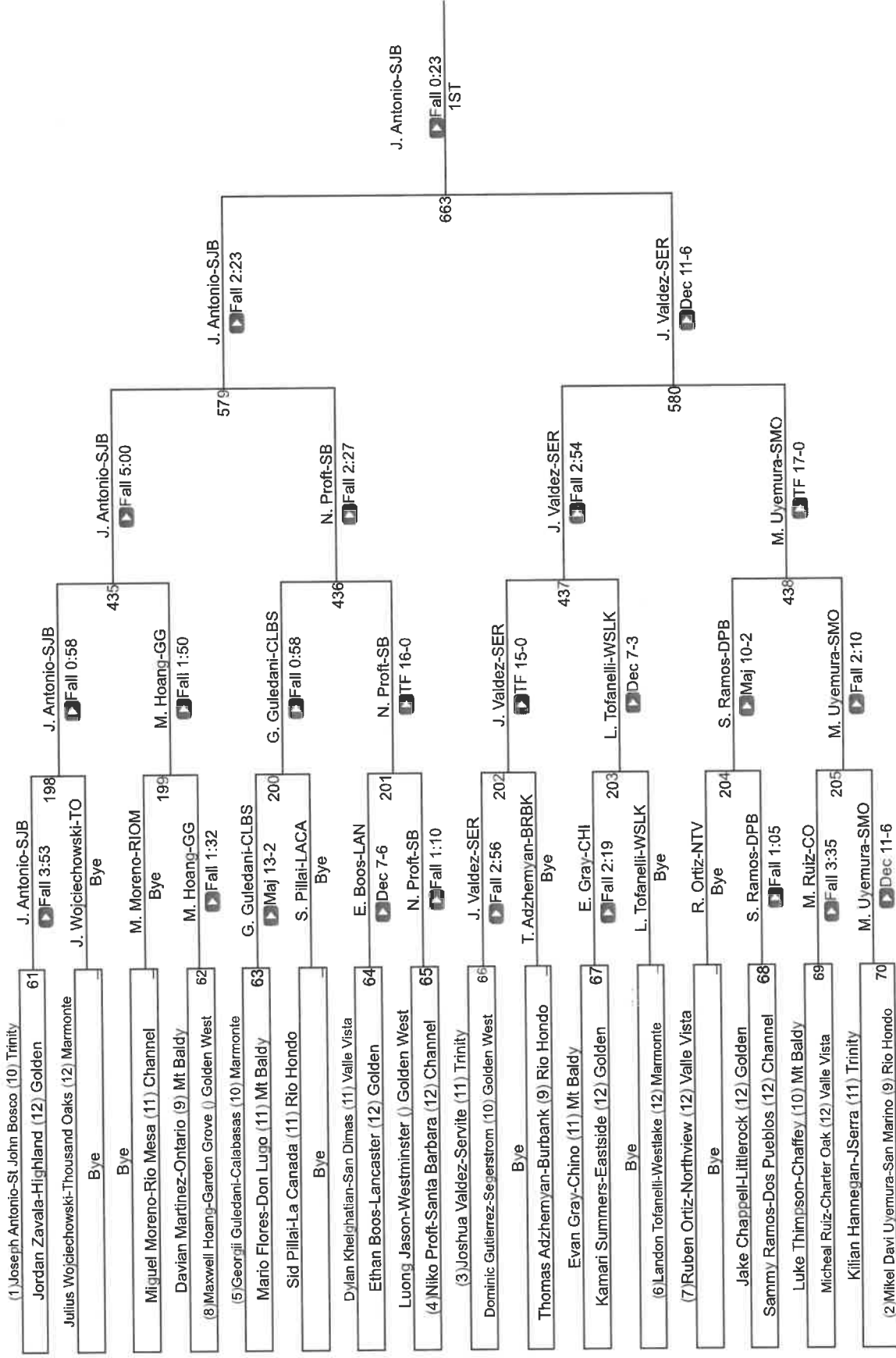

CIF Qualifier 145

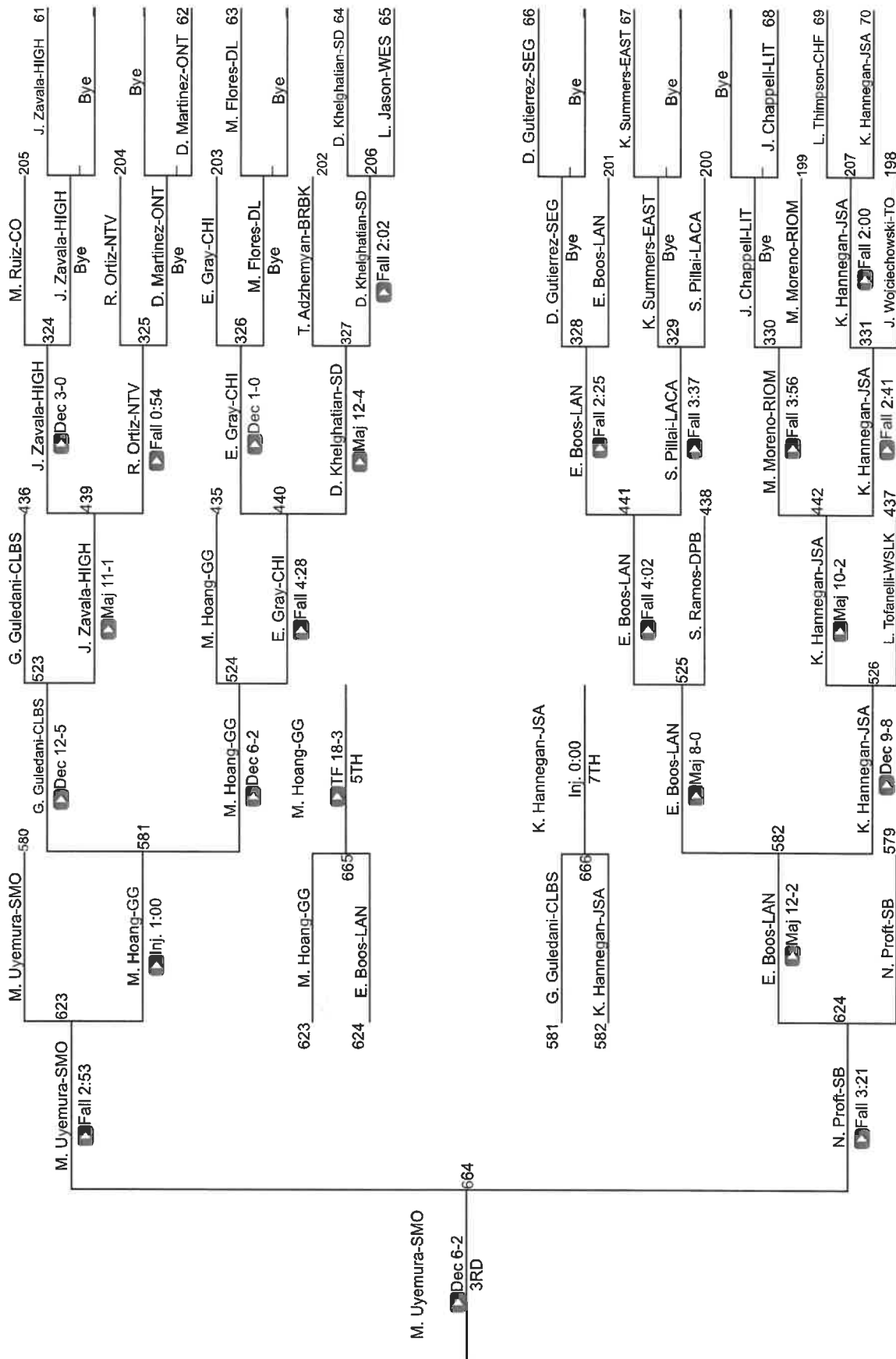

EIF SS Boys Individuals Coastal Div

EIF Qualifier 152

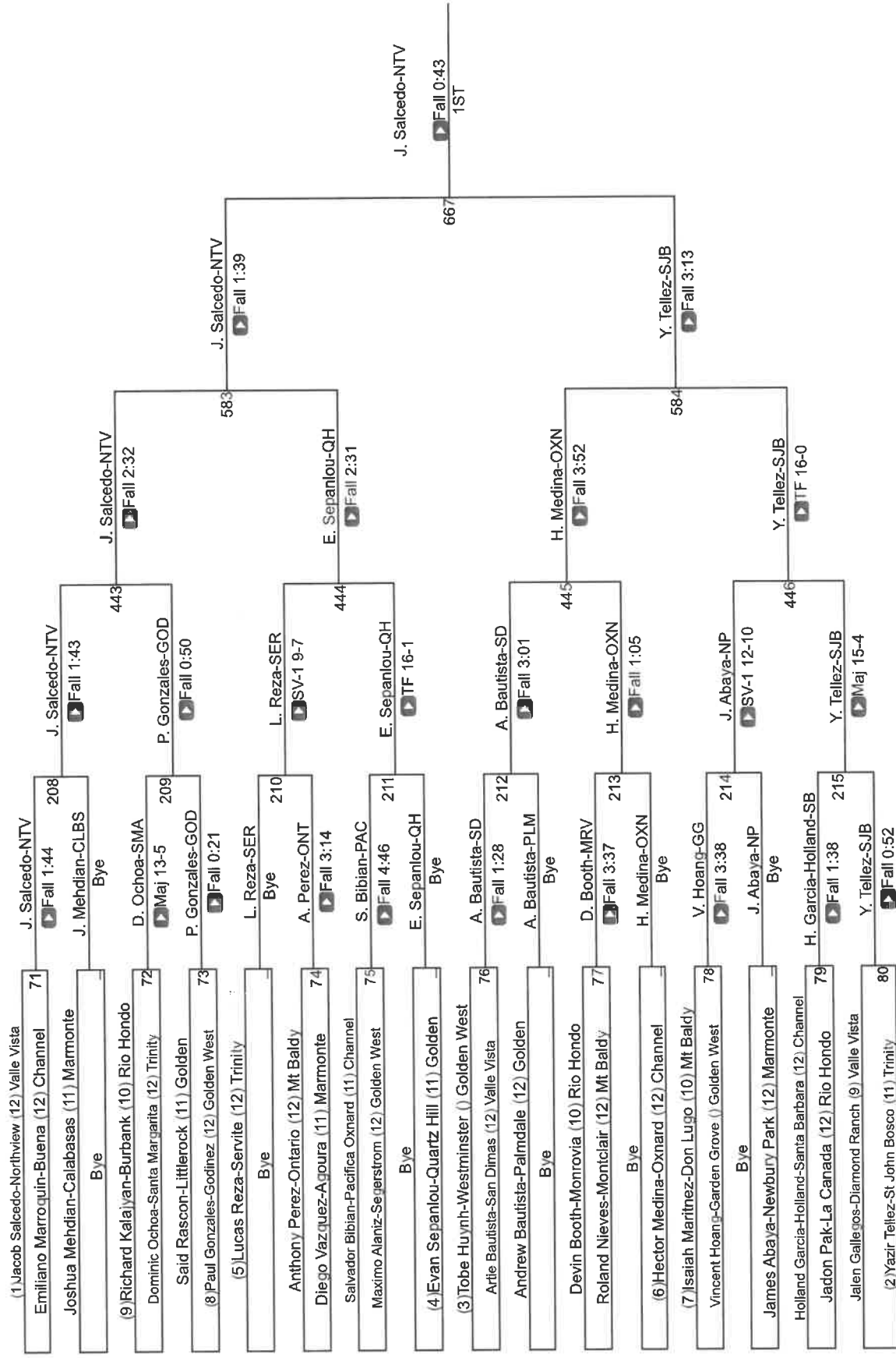

CIF Qualifier 152

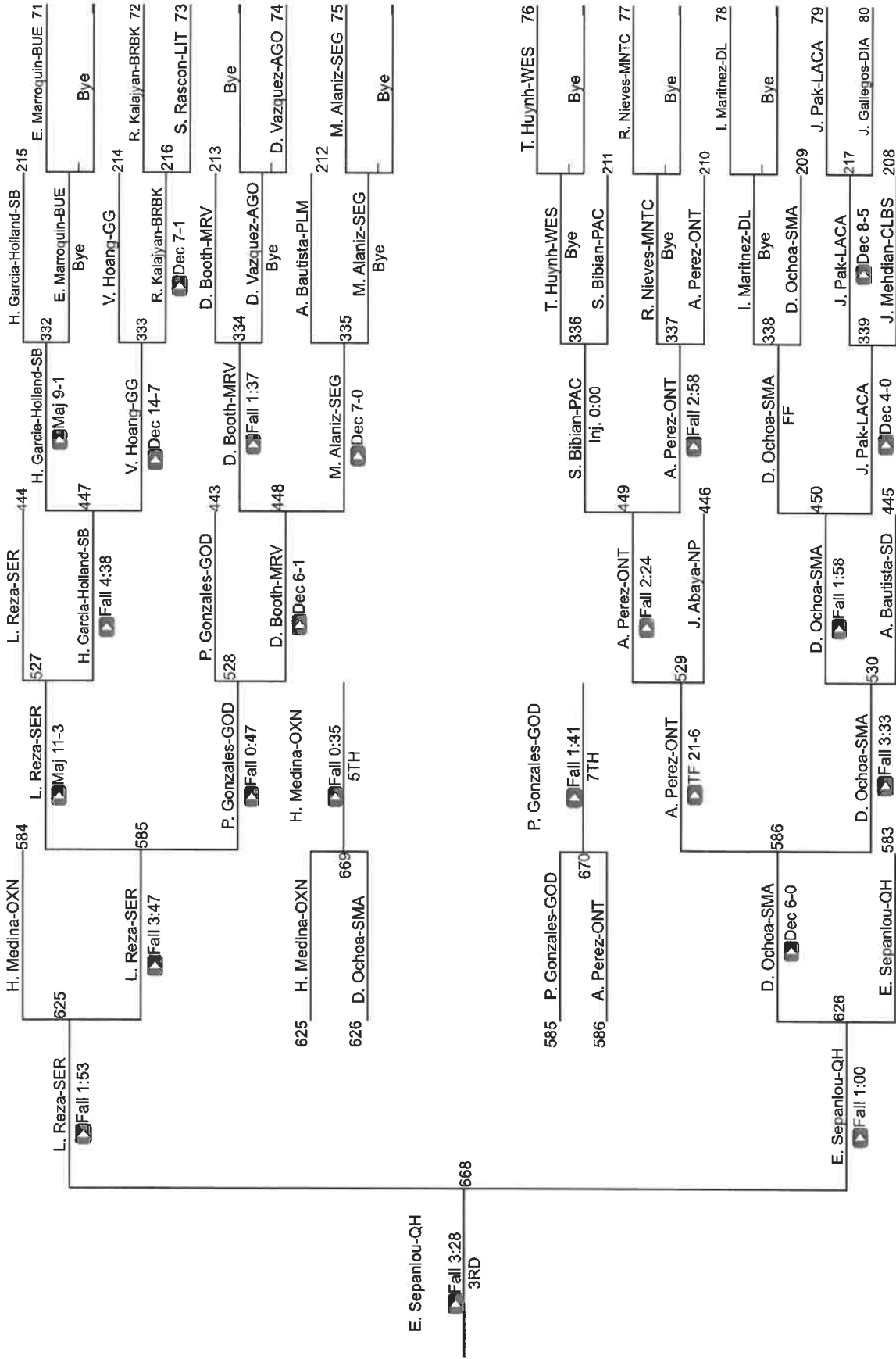

CIF SS Boys Individuals Coastal Div

CIF Qualifier 160

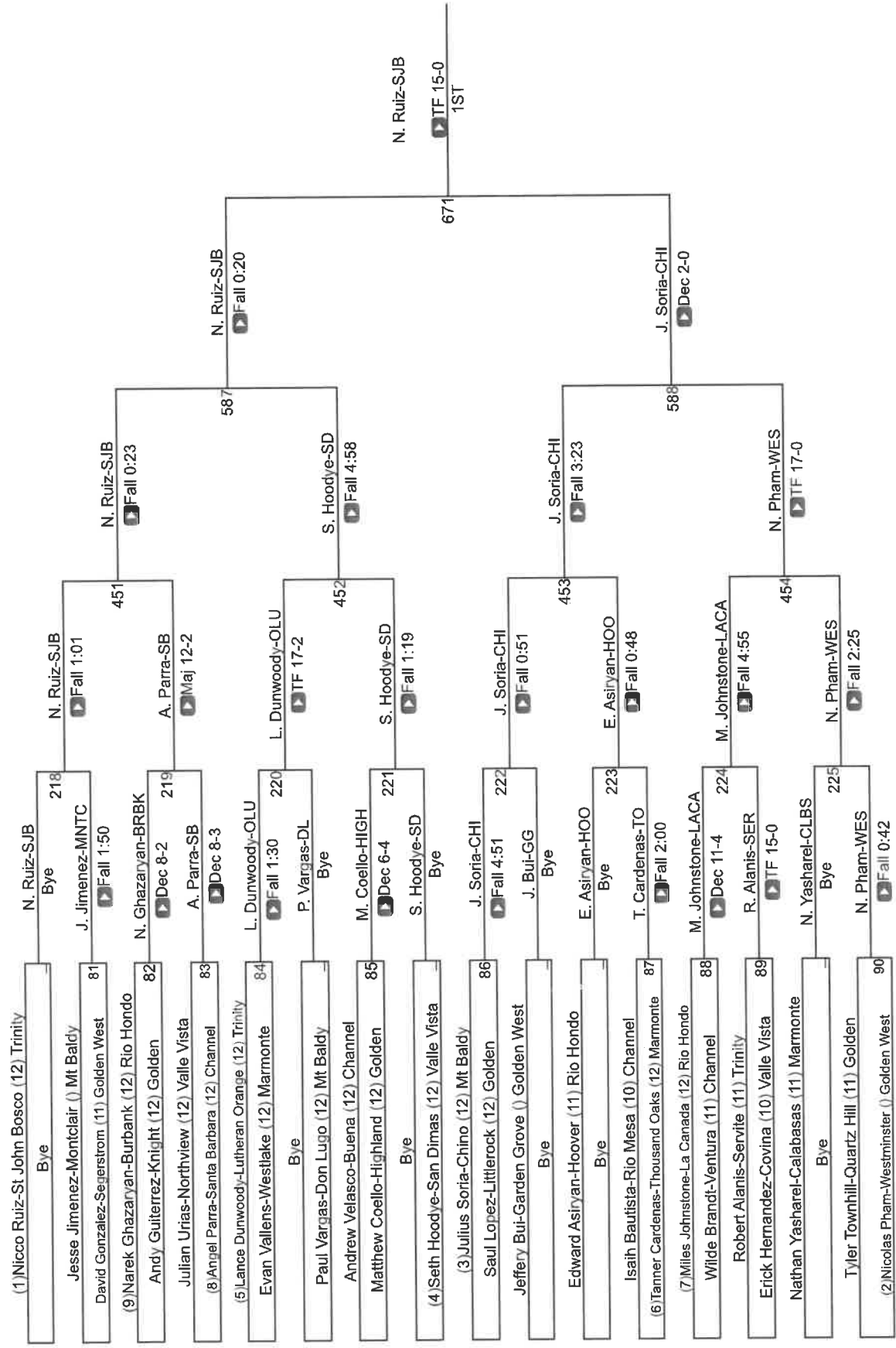

CIF Qualifier 160

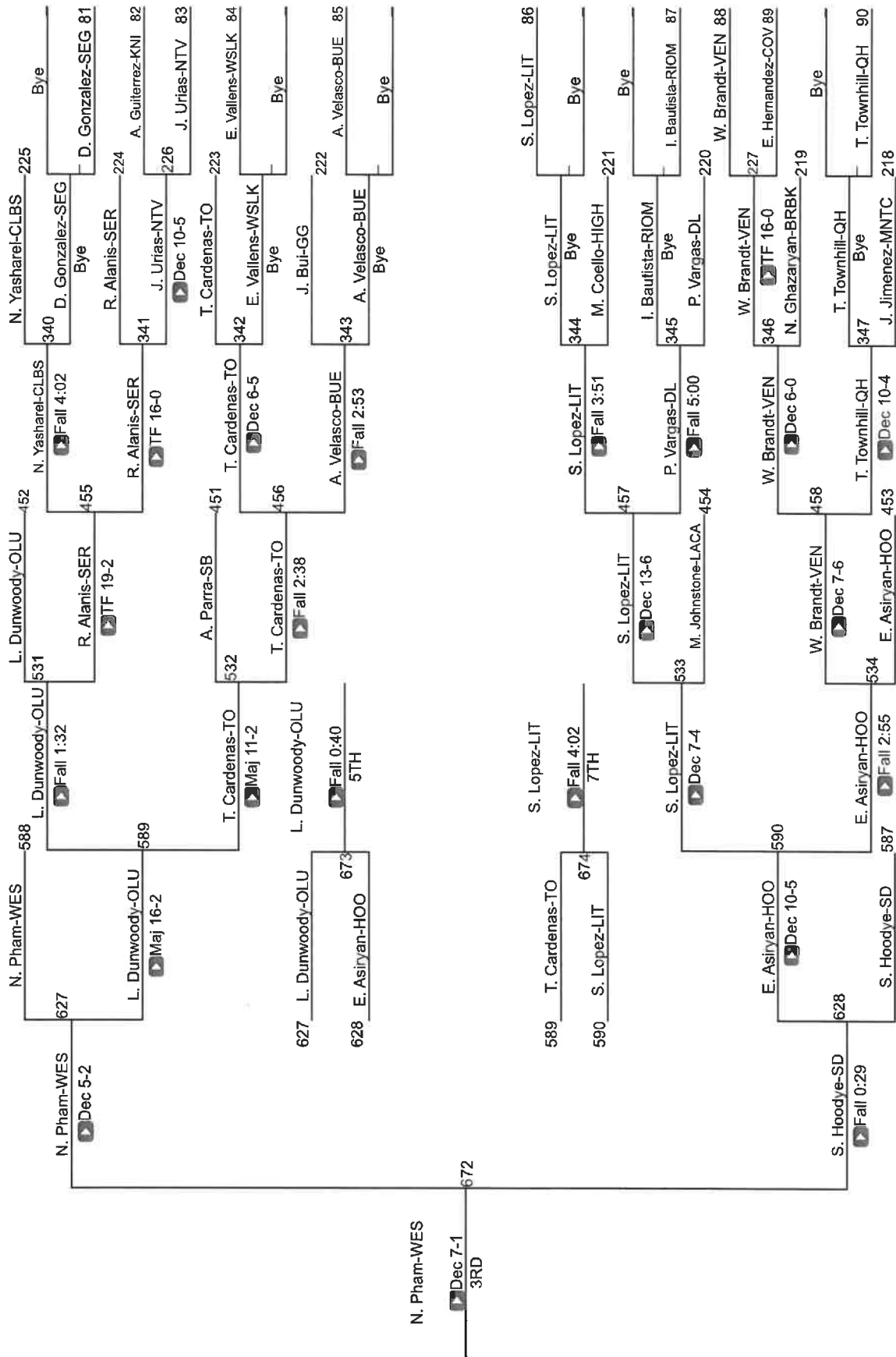

CIF SS Boys Individuals Coastal Div

CIF Qualifier 170

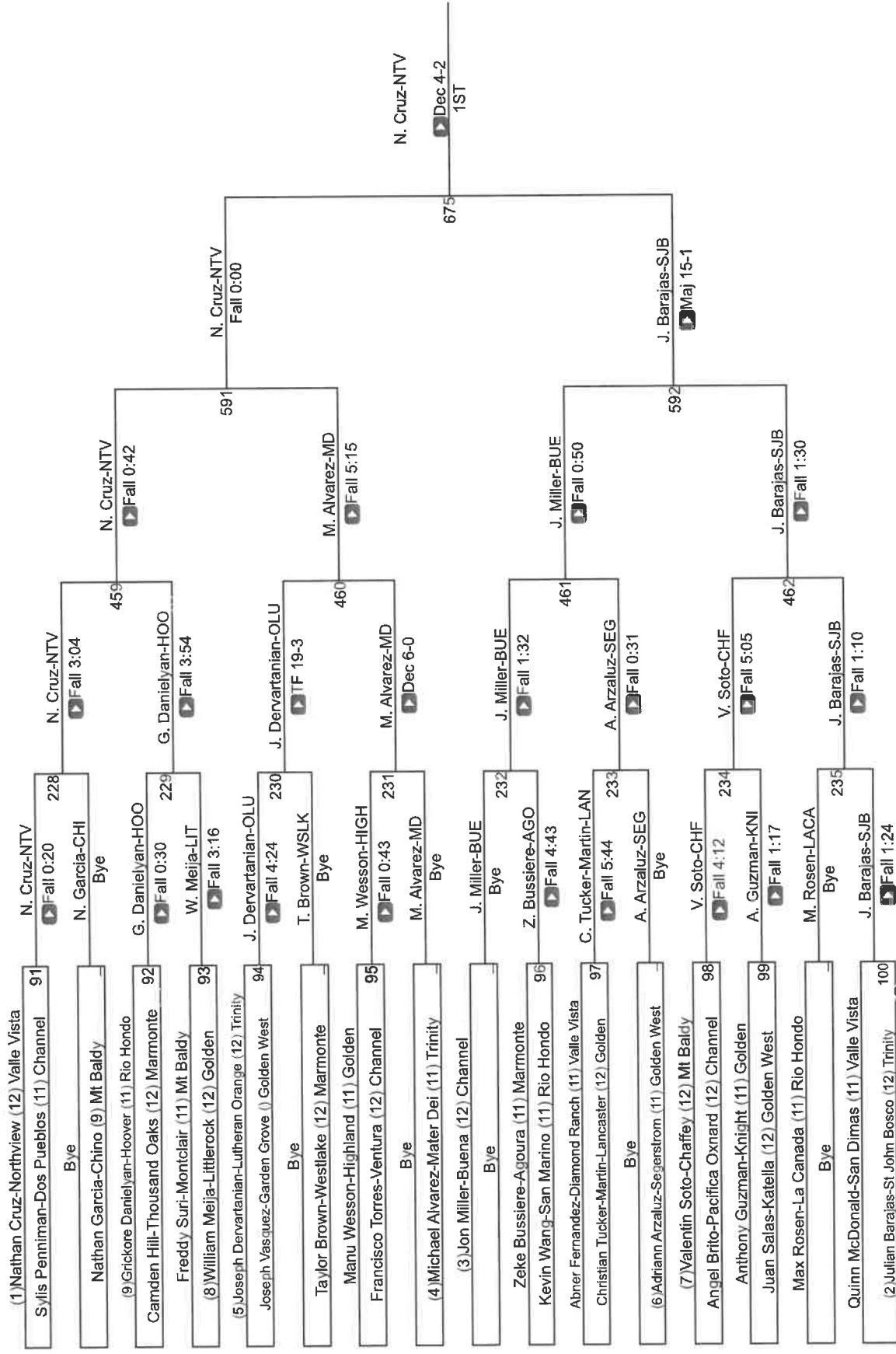

EIF SS Boys Individuals Coastal Div

EIF Qualifier 182

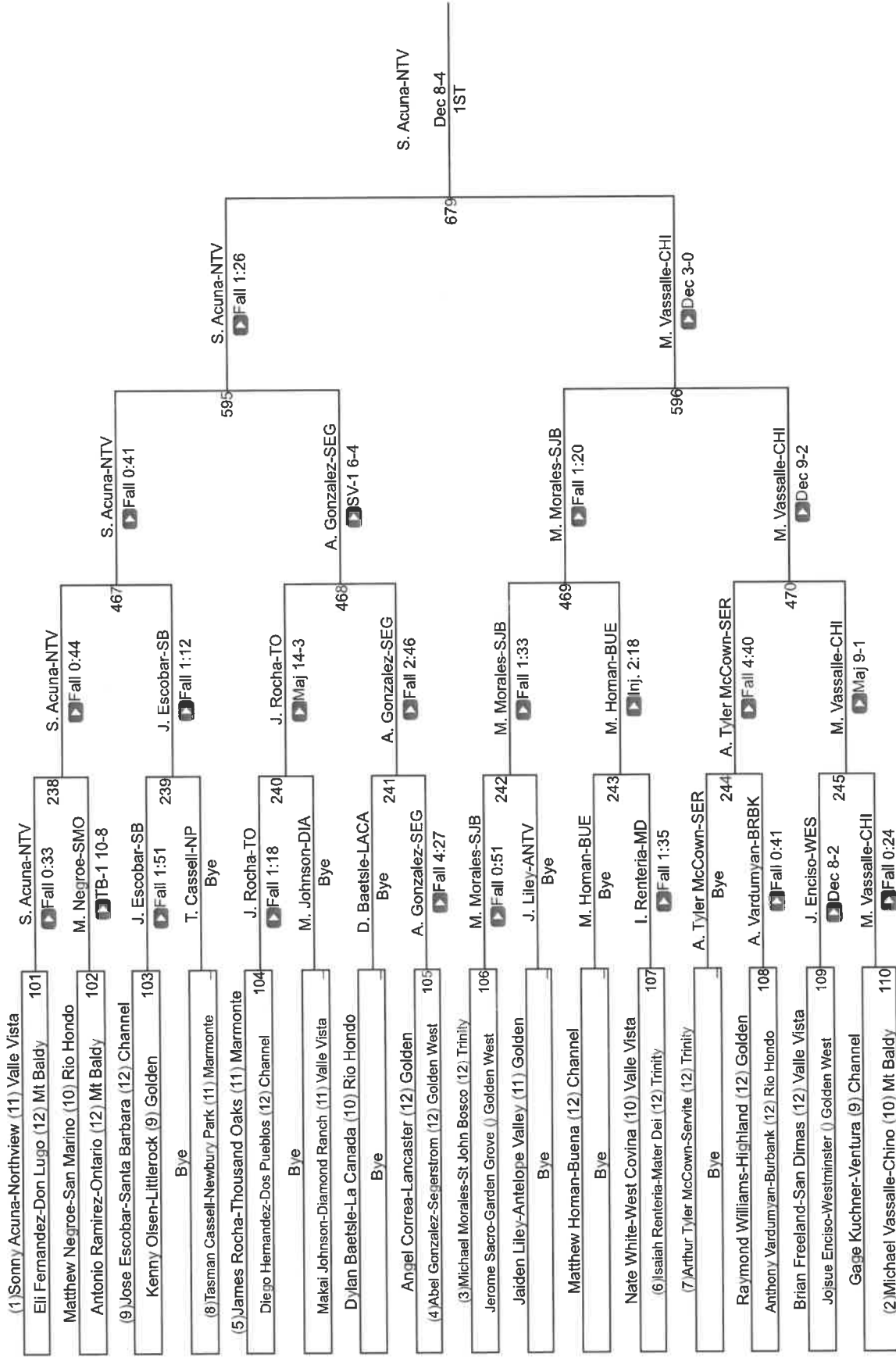

EIF Qualifier 182

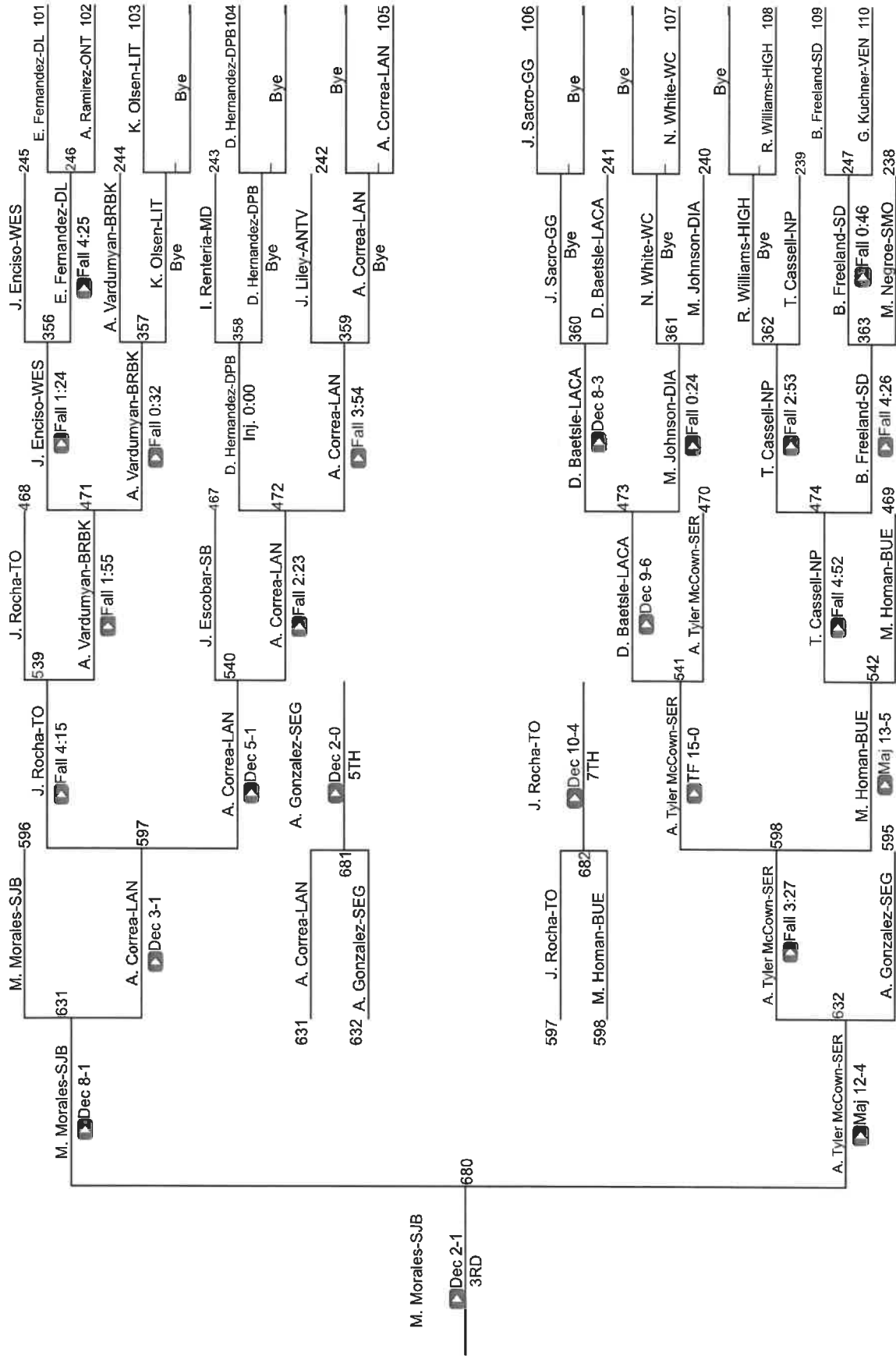

CIF SS Boys Individuals Coastal Div

CIF Qualifier 195

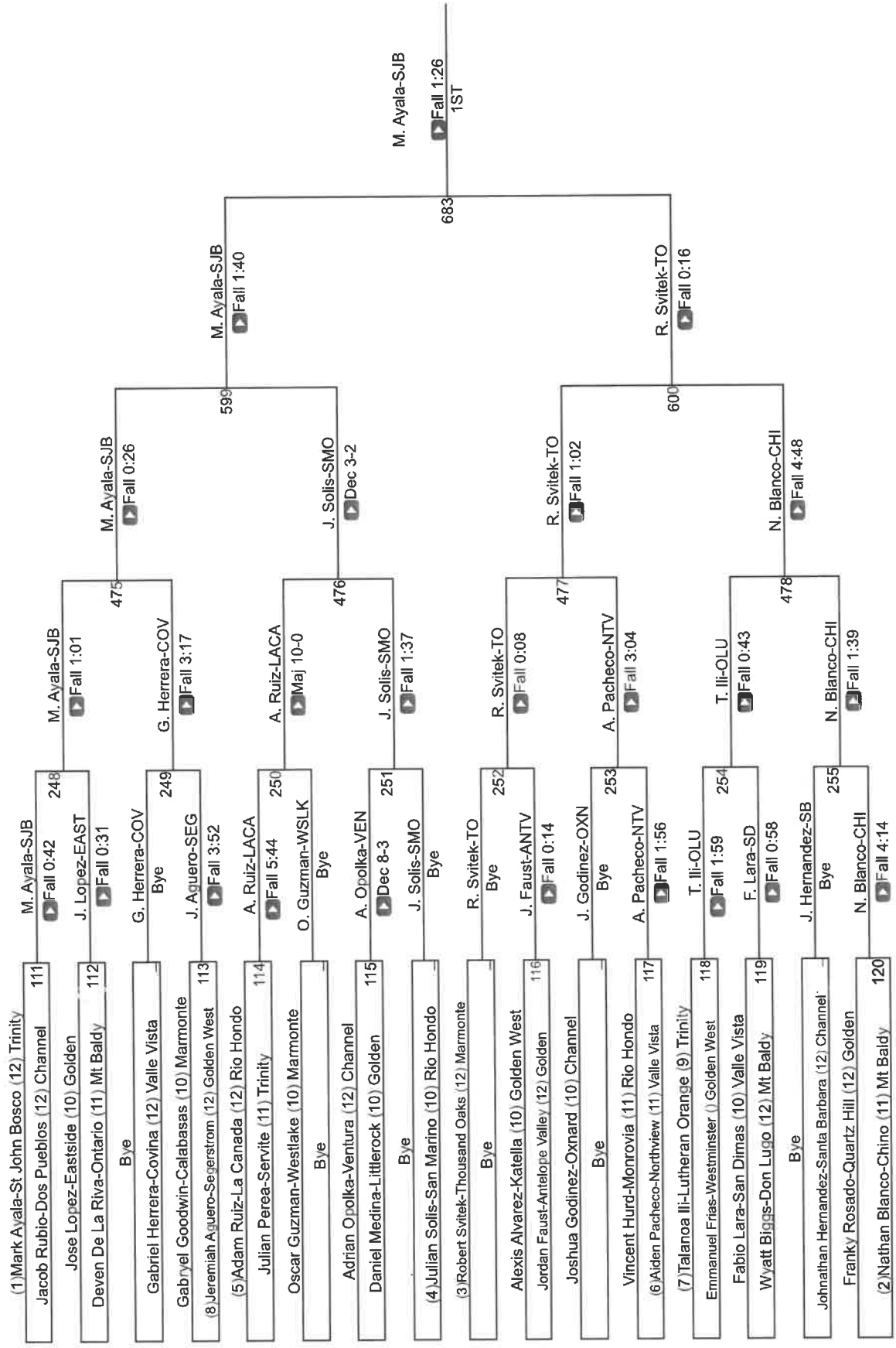

CIF Qualifier 195

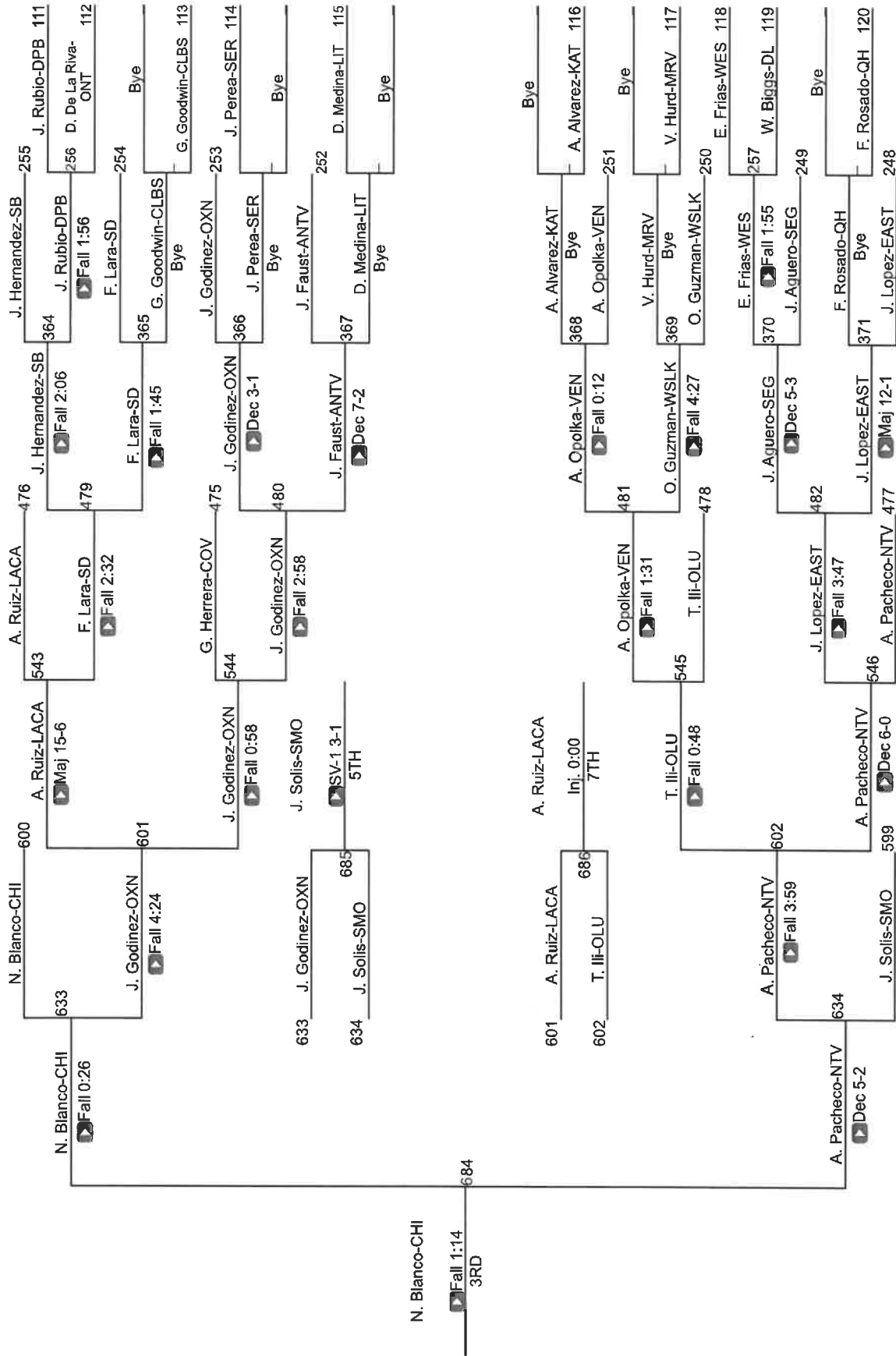

CIF SS Boys Individuals Coastal Div

CIF Qualifier 220

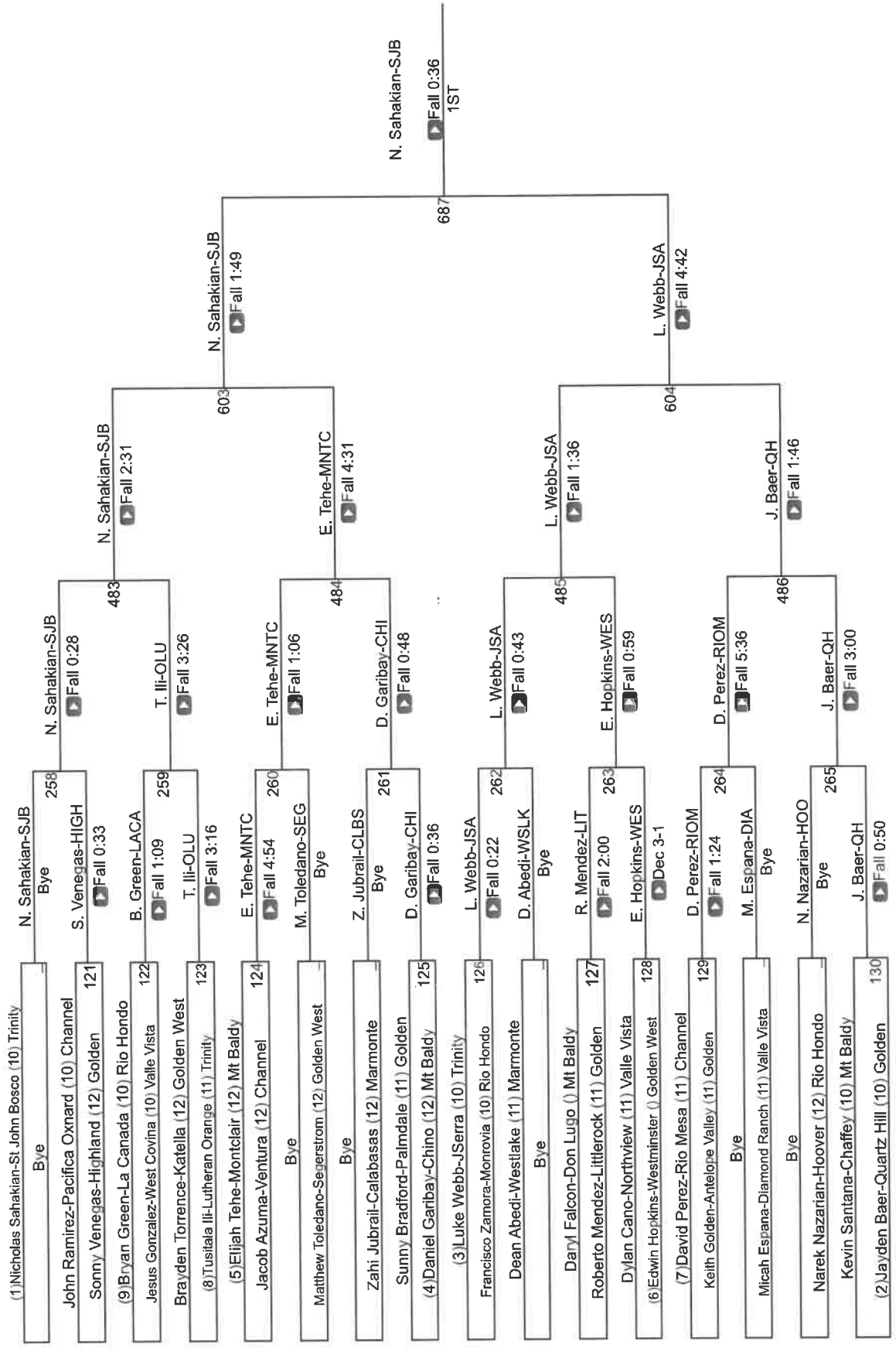

CIF SS Boys Individuals Coastal Div

CIF Qualifier 285

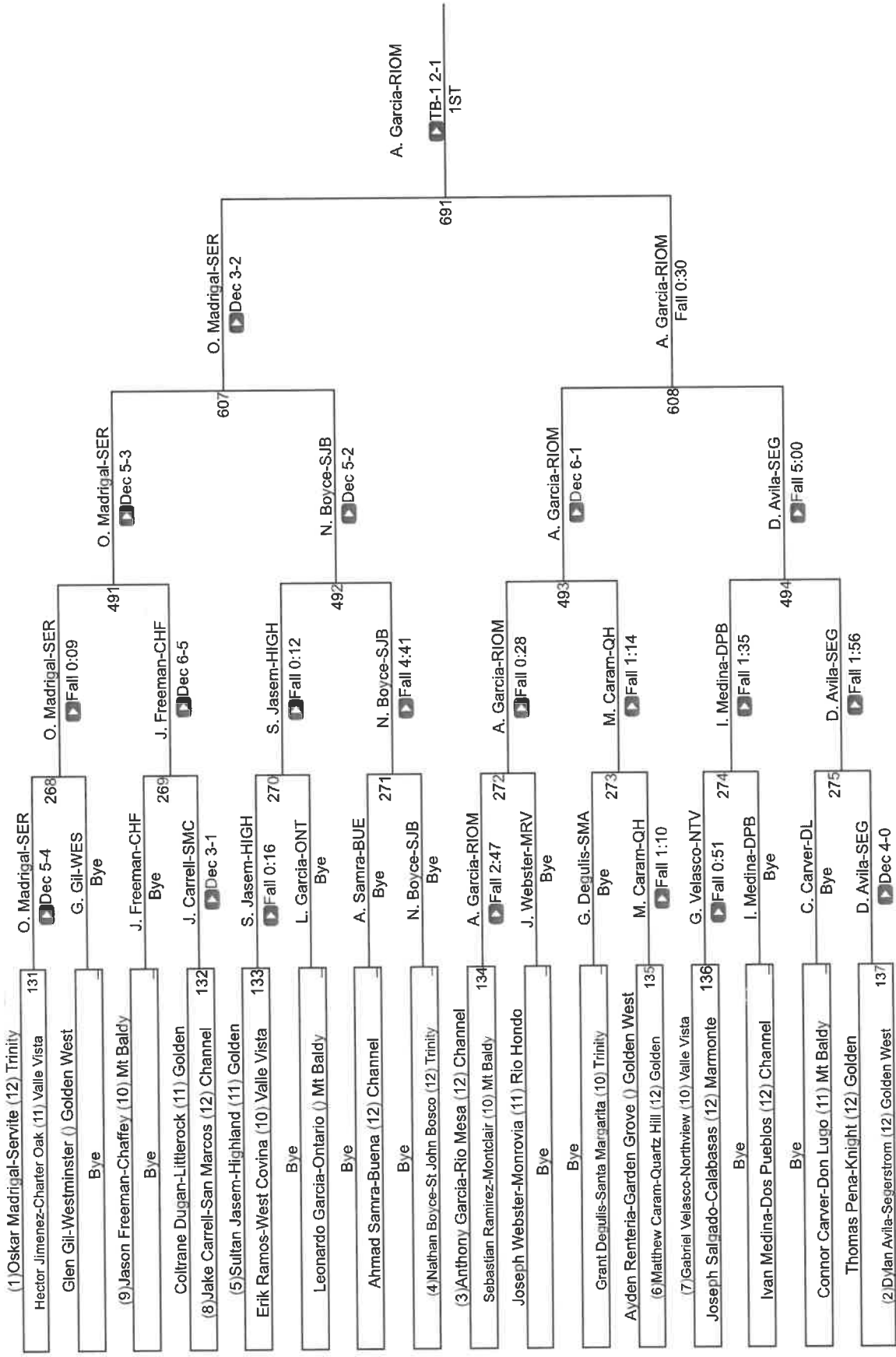

CIF Qualifier 285

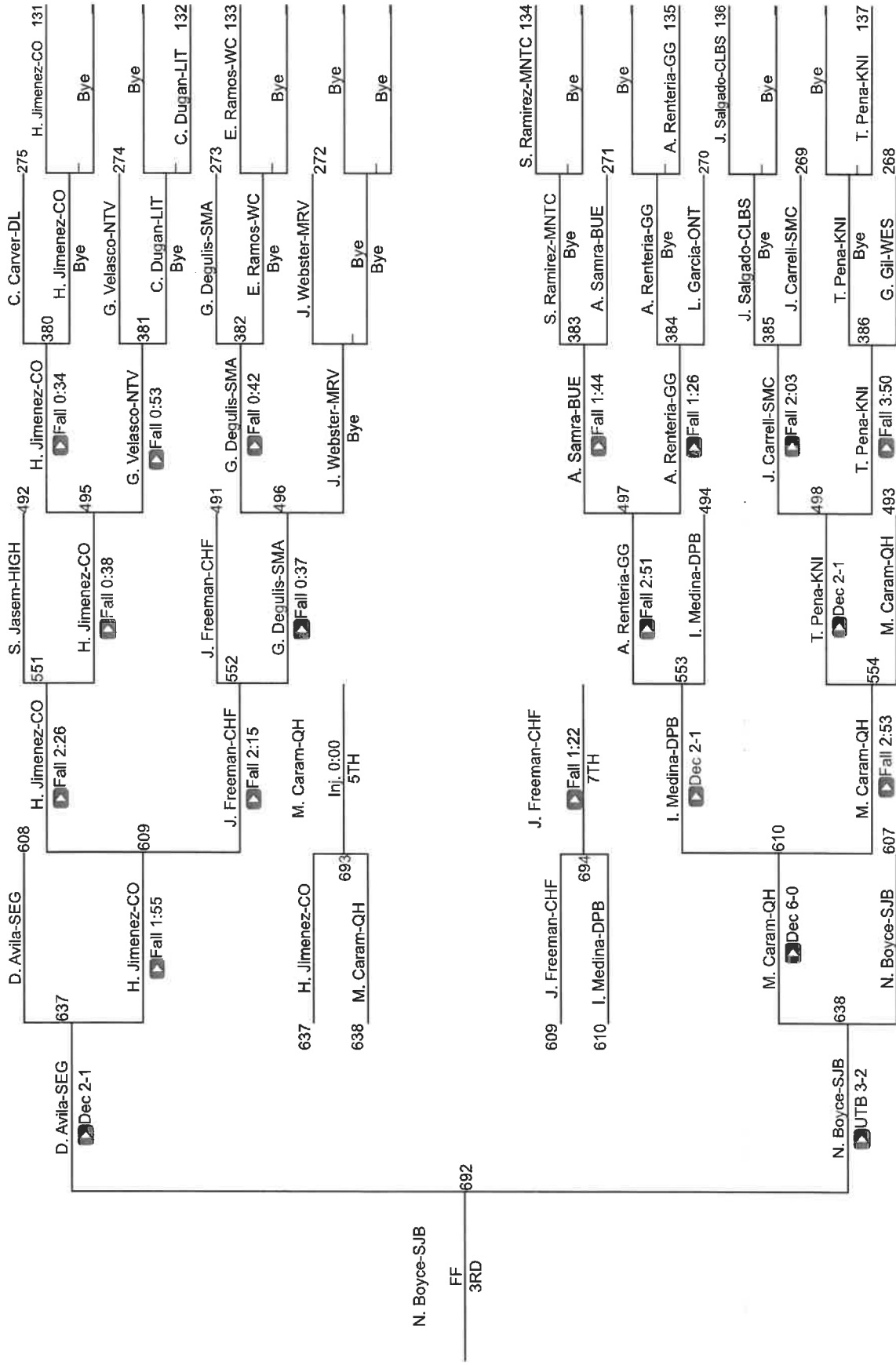

CIF SS Boys Individuals

Eastern Division

Capistrano Valley High School

February 10-11, 2023



Lower Weight MVP

Erik Ramirez
Palm Desert
106 Pounds

Upper Weight MVP

Daniel Herrera
Palm Desert
285 Pounds

Placers

106 Pounds			152 Pounds			Team Score Final		
1st	Erik Ramirez	Palm Desert	1st	Beau Mantanona	Palm Desert	1	Palm Desert	340
2nd	Elijah Poe	Calvary Chapel SA	2nd	Andrew Asbury	Trabuco Hills	2	Calvary Chapel SA	239.5
3rd	Solomon Resnick	Capistrano Valley	3rd	Dominic Morales	San Clemente	3	Trabuco Hills	214.5
4th	Logan Hansen	Royal	4th	Benjamin Kirk	Royal	4	Camarillo	170
5th	Andrew Rubalcaba	Montebello	5th	Robert Baeder	Dana Hills	5	San Clemente	149.5
6th	Trey Gotanda	Schurr	6th	Cross Rodriguez	Calvary Chapel SA	6	Royal	122
7th	Dayle Cailles	Valencia	7th	Isalah Lugo	Montebello	7	La Quinta	114.5
8th	Deven Welch	La Quinta	8th	Luciano Benenati	Aliso Niguel	8	Aliso Niguel	98.5
113 Pounds			160 Pounds			9	West Valley	94
1st	Aaron Silva	Calvary Chapel SA	1st	David Alonso	Palm Desert	10	Liberty	91
2nd	Mason Carrillo	Royal	2nd	Gabriel Barragan	West Valley	11	Dana Hills	82.5
3rd	Diego Garcia Perez	Trabuco Hills	3rd	Noah Zuniga	Trabuco Hills	12	Cerritos	77.5
4th	Edmon Altunyan	Montebello	4th	Dylan Trevino	Calvary Chapel SA	13	Montebello	74
5th	Ethan Mourer	Capistrano Valley	5th	Victor Rodarte	Tesoro	14	John Glenn	70.5
6th	James Fukuchi	Cerritos	6th	Fred Grant	Aliso Niguel	15	Capistrano Valley	70
7th	Salvador Ardon	Camarillo	7th	Matin Ghanavat	Capistrano Valley	16	Valencia	69
8th	Carlos Dylan	Shadow Hills	8th	Neo Neri	Simi Valley	17	Shadow Hills	64
120 Pounds			170 Pounds			18	Costa Mesa	63.5
1st	Jaxson Taber	Palm Desert	1st	Erik McCown	Palm Desert	19	Tesoro	56
2nd	Logan Andrews	Moorpark	2nd	Max McWilliams	Calvary Chapel SA	20	El Toro	53
3rd	Santino Nonaca	San Clemente	3rd	Zach Harkey	Dana Hills	21	Schurr	53
4th	Christian Espinoza	Cerritos	4th	Danny Frailey	Trabuco Hills	22	Palm Springs	48
5th	Jason Gomez	Capistrano Valley	5th	Nicholas Madrigal	Royal	23	San Juan Hills	44
6th	Arturo Alfaro	Camarillo	6th	Jeremiah Strauss	El Toro	24	Moorpark	39
7th	Jacob Balladares	Shadow Hills	7th	Nathan Hutton	West Valley	25	Calvary Chapel Downey	38.5
8th	Troy Torres	Calvary Chapel SA	8th	Jared Flores	San Jacinto	26	Orange	38
126 Pounds			182 Pounds			27	Bell Gardens	35
1st	Joshua Requena	Camarillo	1st	Alex Munoz	Valencia	28	Santa Ana	30
2nd	Vincenzo Benenati	Aliso Niguel	2nd	Talha Bektas	Calvary Chapel SA	29	Mission Viejo	23.5
3rd	Isaac Mendoza Martinez	Trabuco Hills	3rd	Logan Witten	Trabuco Hills	30	Citrus Hill	23
4th	Cristian Morales	Tesoro	4th	Bronson Swan	Palm Desert	31	Vista Del Lago	22
5th	Jacob Enriquez	John Glenn	5th	George Lewis	West Valley	32	Orange Vista	21
6th	Dane Curran	Costa Mesa	6th	Bryan Camargo	Dana Hills	33	Rancho Mirage	21
7th	Jayden Ho	San Clemente	7th	Brett Williamson	Moorpark	34	Perris	19.5
8th	Vincent Hanna	Calvary Chapel SA	8th	Nehemiah Ramirez	Shadow Hills	35	San Jacinto	18
132 Pounds			195 Pounds			36	Santiago GG	18
1st	Benjamin Wimberly	San Clemente	1st	Daniel Gurovich	Camarillo	37	Mark Keppel	16
2nd	Ernilio Medina	Camarillo	2nd	Diego Morales	Palm Desert	38	Simi Valley	15
3rd	Dylan Guillermo	Palm Desert	3rd	Dylan Backer	Liberty	39	Tahquitz	13
4th	Josiah Tessandore	La Quinta	4th	Alex Lopez	Valencia	40	Pioneer	11
5th	Will Larson	Calvary Chapel Downey	5th	Juan Limon	Shadow Hills	41	Valley View	11
6th	Lin Jayden	Cerritos	6th	Alejandro Marquez	Aliso Niguel	42	Alhambra	4
7th	Jose Mejia	Vista Del Lago	7th	Ruben Gracian	John Glenn	43	Artesia	4
8th	Juan Martinez	West Valley	8th	Calvin Velasco	Royal	44	Saddleback	4
138 Pounds			220 Pounds			45	Estancia	3
1st	Brock Mantanona	Palm Desert	1st	Henry Sturm	Trabuco Hills	46	Rancho Verde	0
2nd	Michael Folch	Calvary Chapel SA	2nd	Jose Zendejas	La Quinta	47	Xavier Prep	0
3rd	Daniel Simons	Camarillo	3rd	Peter Fulgentes	Royal	48	San Gabriel	-1
4th	Saul Mireles	La Quinta	4th	David Calix	Costa Mesa			
5th	Eduardo Espinosa	West Valley	5th	Joseph Martinez	Bell Gardens			
6th	Trevor Antoniou	El Toro	6th	Javier Castillo	Perris			
7th	Joseph Cimarusti	Mark Keppel	7th	Jacob Ramirez	Liberty			
8th	Adam Wronski	San Clemente	8th	Nelson Lecona	Dana Hills			
145 Pounds			285 Pounds					
1st	Andrew Barbosa	Palm Desert	1st	Daniel Herrera	Palm Desert			
2nd	Steve Caday	Calvary Chapel SA	2nd	John Givens	Palm Springs			
3rd	Jacob Belden	San Clemente	3rd	John Phillips	Liberty			
4th	Jake Topartz	San Juan Hills	4th	Nathan Nieves	Calvary Chapel SA			
5th	Avesta Dadrass	Trabuco Hills	5th	Jerry Young	Orange			
6th	Junior Mahan	West Valley	6th	Thomas Lund	Costa Mesa			
7th	Zale Ming	Mission Viejo	7th	James Perez	Aliso Niguel			
8th	Tomas Fulgentes	Royal	8th	Juan Delgado	Rancho Mirage			

CIF SS Boys Individuals Eastern Div

CIF Qualifier 106

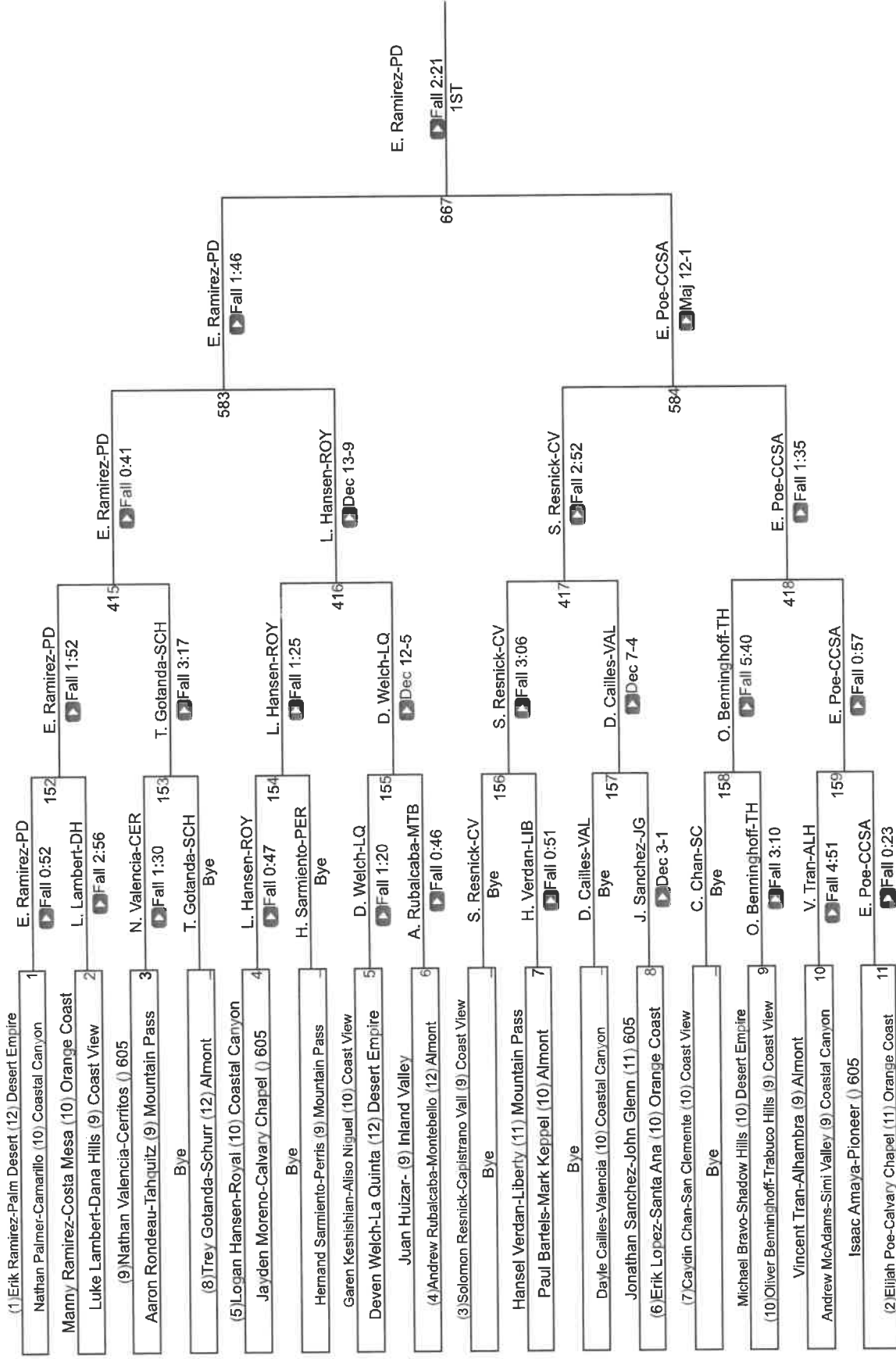

CIF Qualifier 106

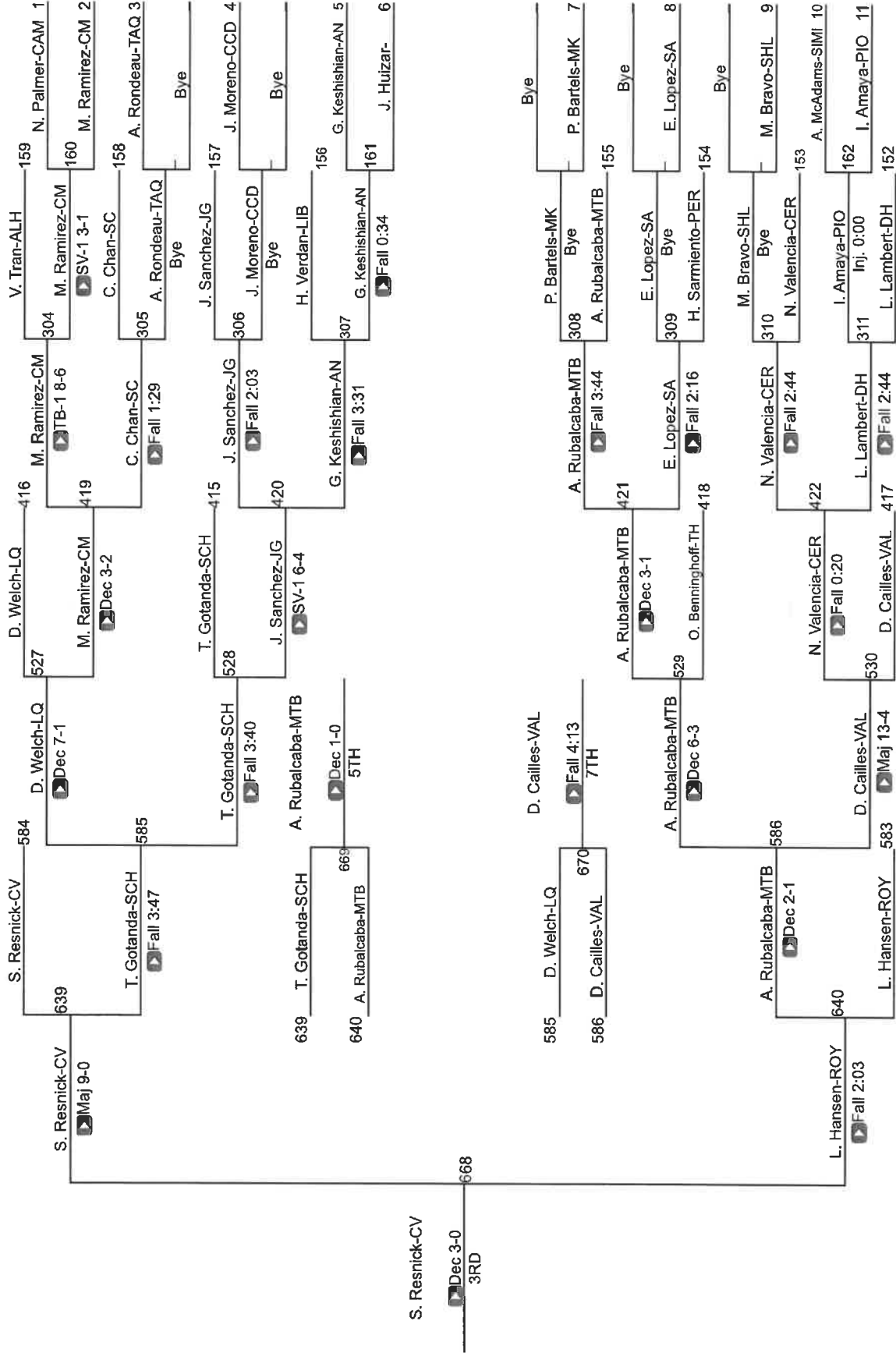

CIF SS Boys Individuals Eastern Div

CIF Qualifier 113

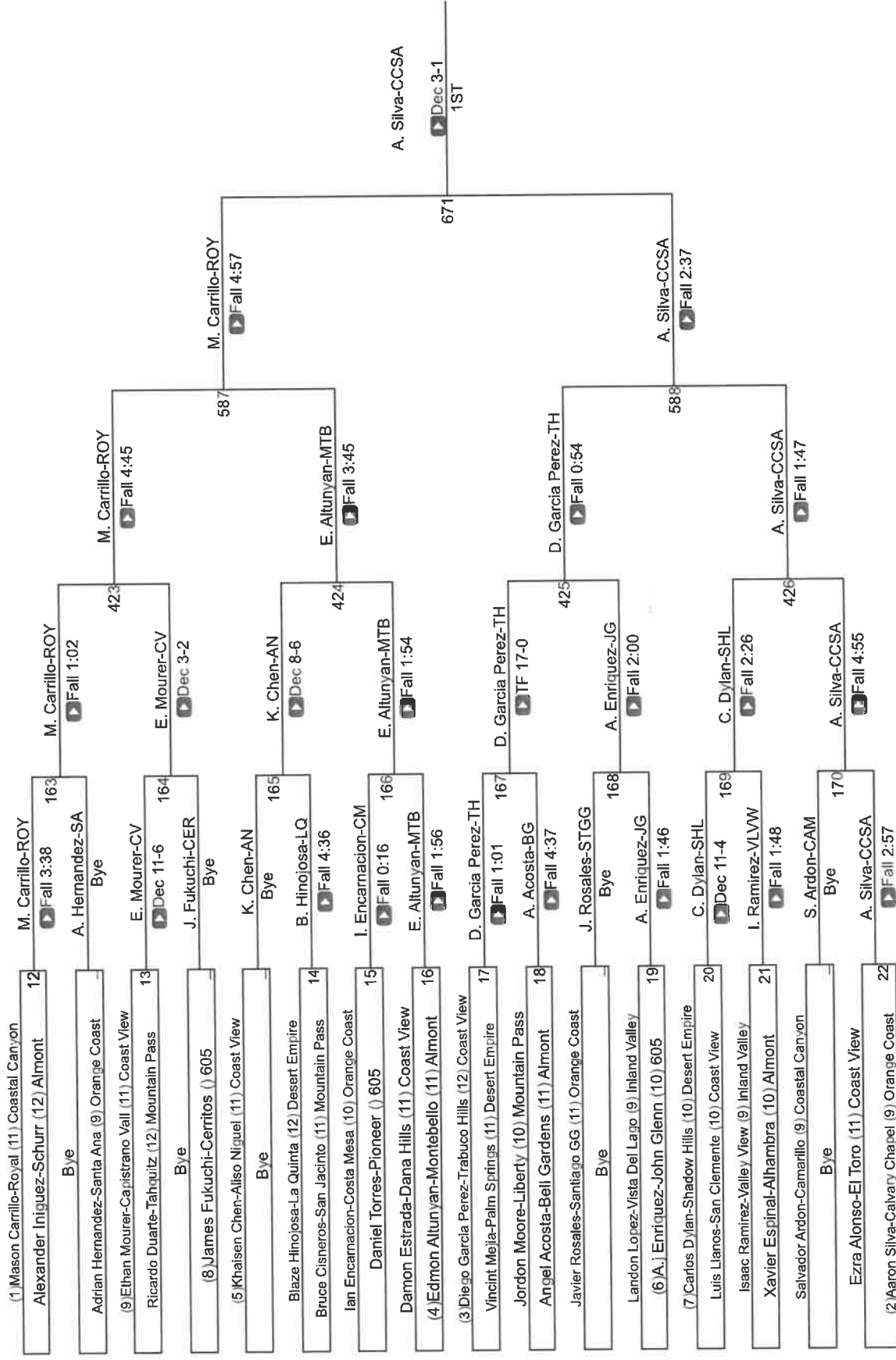

CIF SS Boys Individuals Eastern Div

CIF Qualifier 120

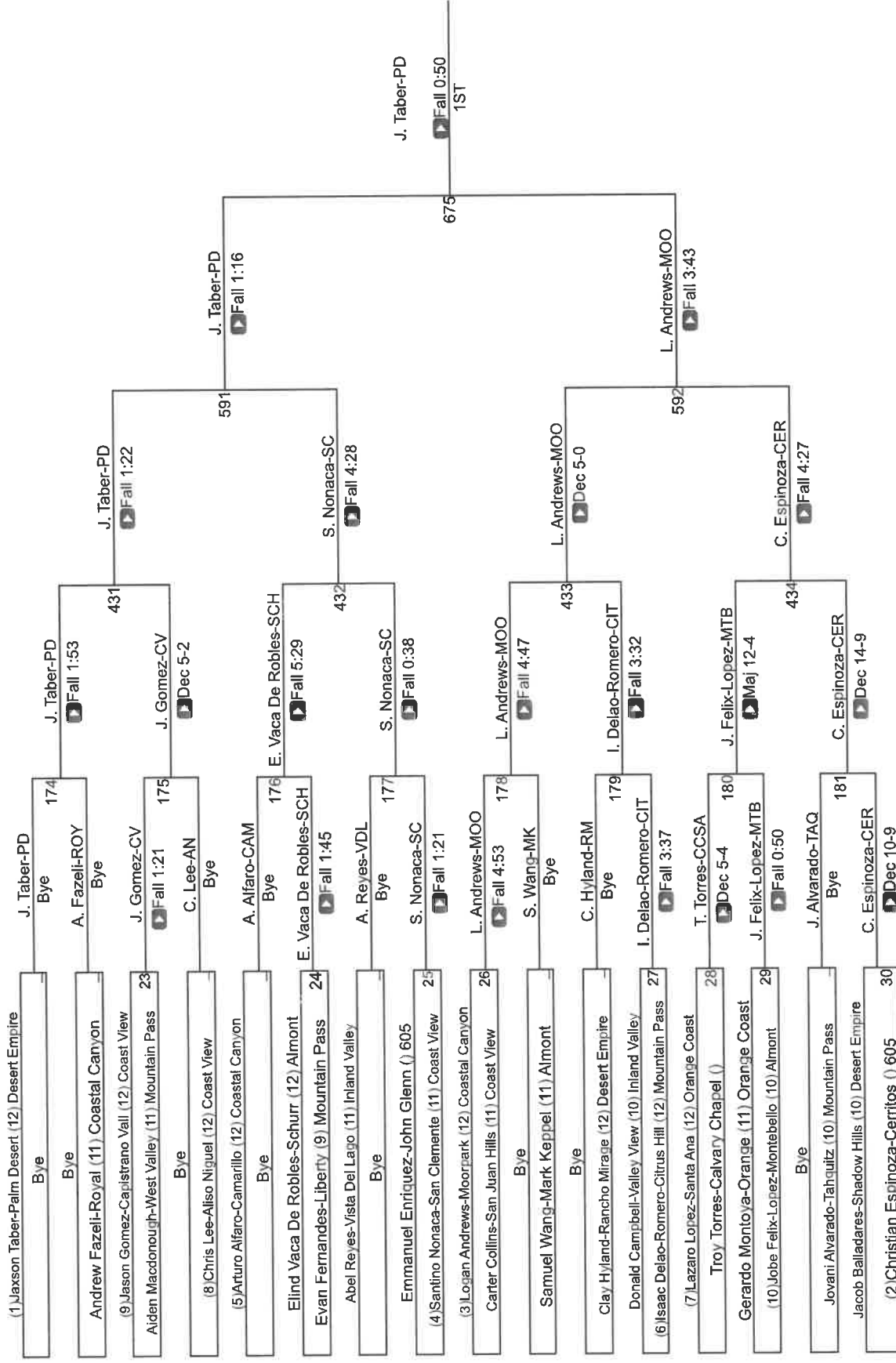

CIF Qualifier 126

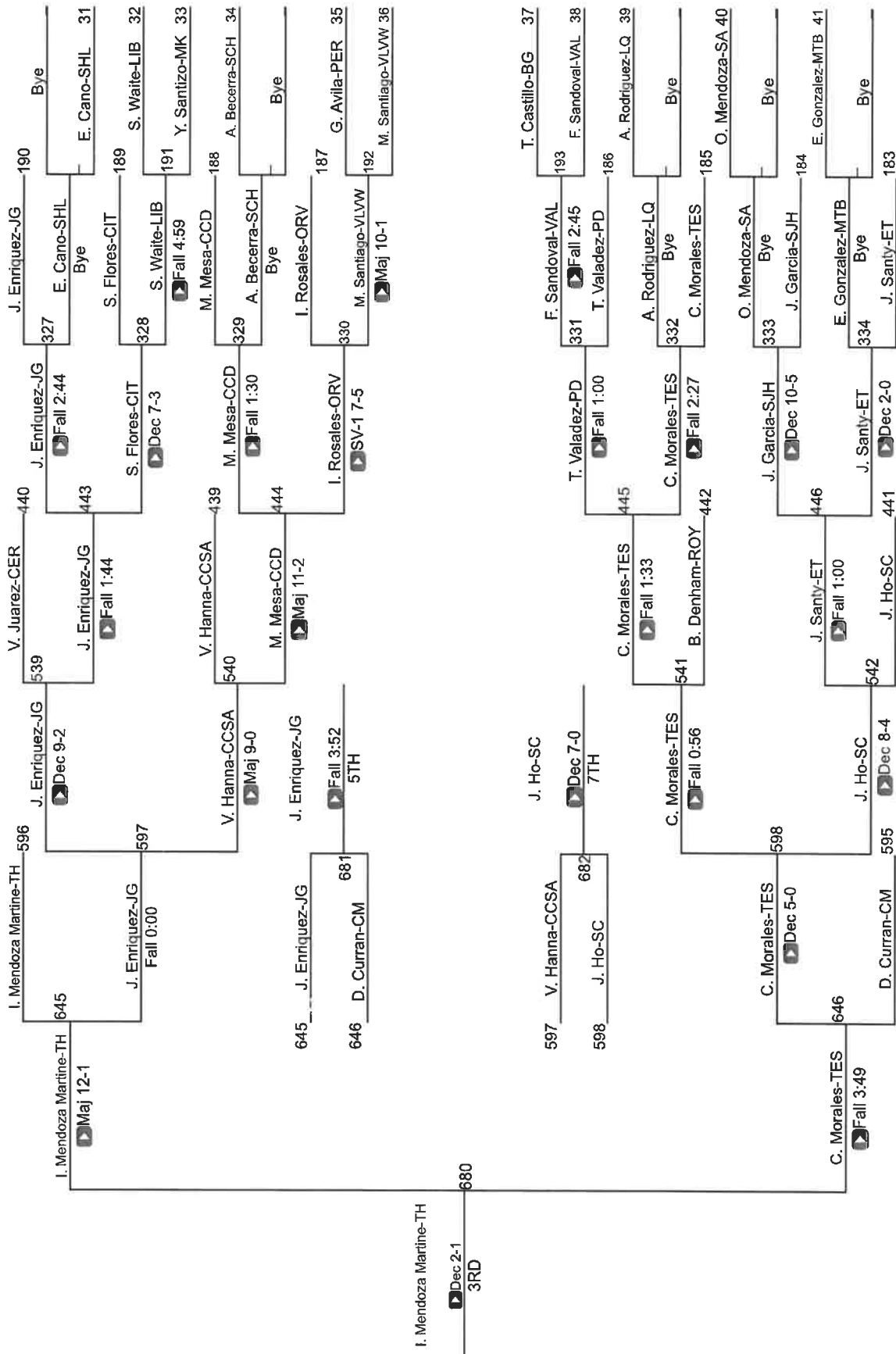

CIF SS Boys Individuals Eastern Div

CIF Qualifier 132

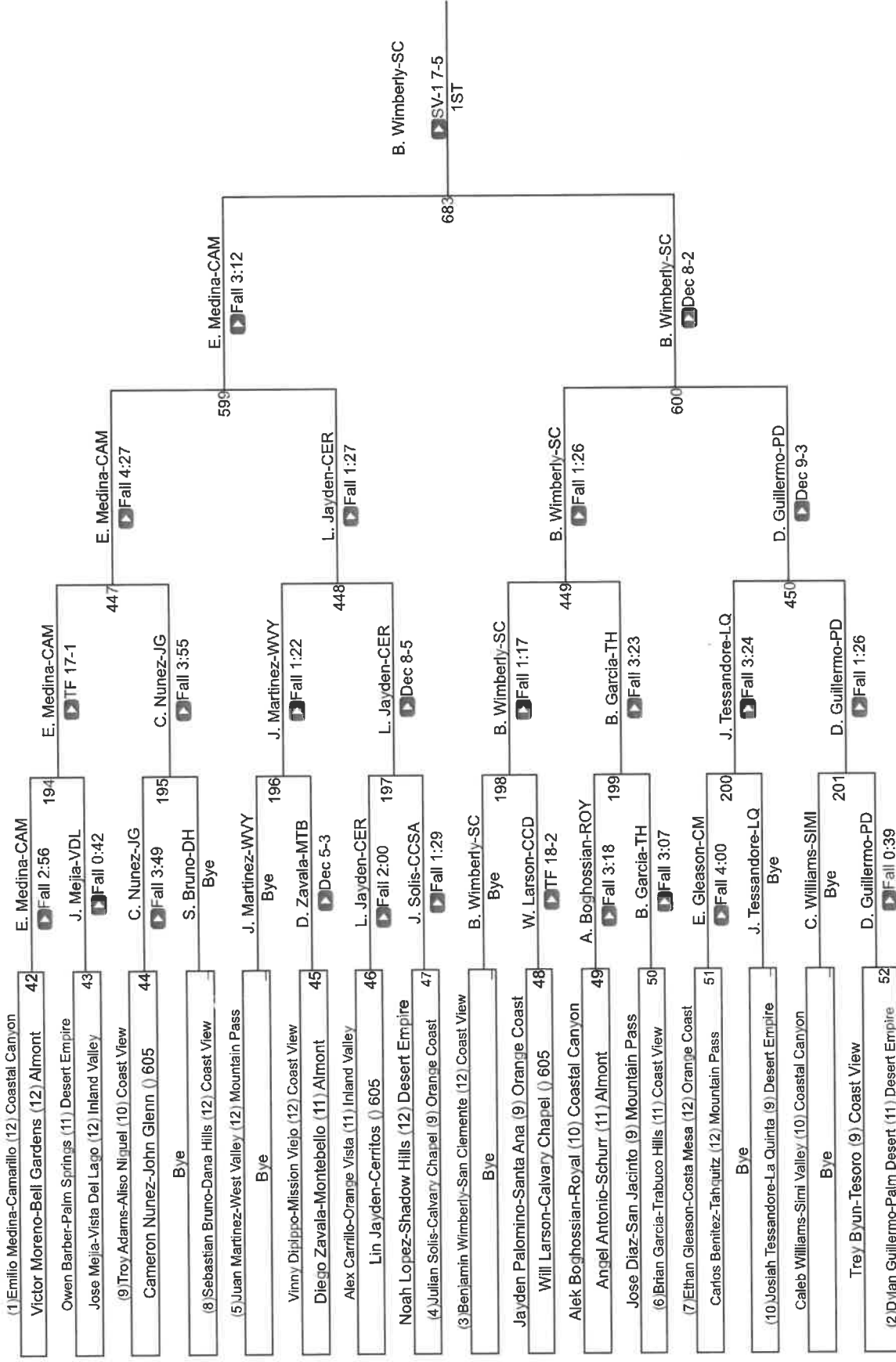

CIF SS Boys Individuals Eastern Div

CIF Qualifier 138

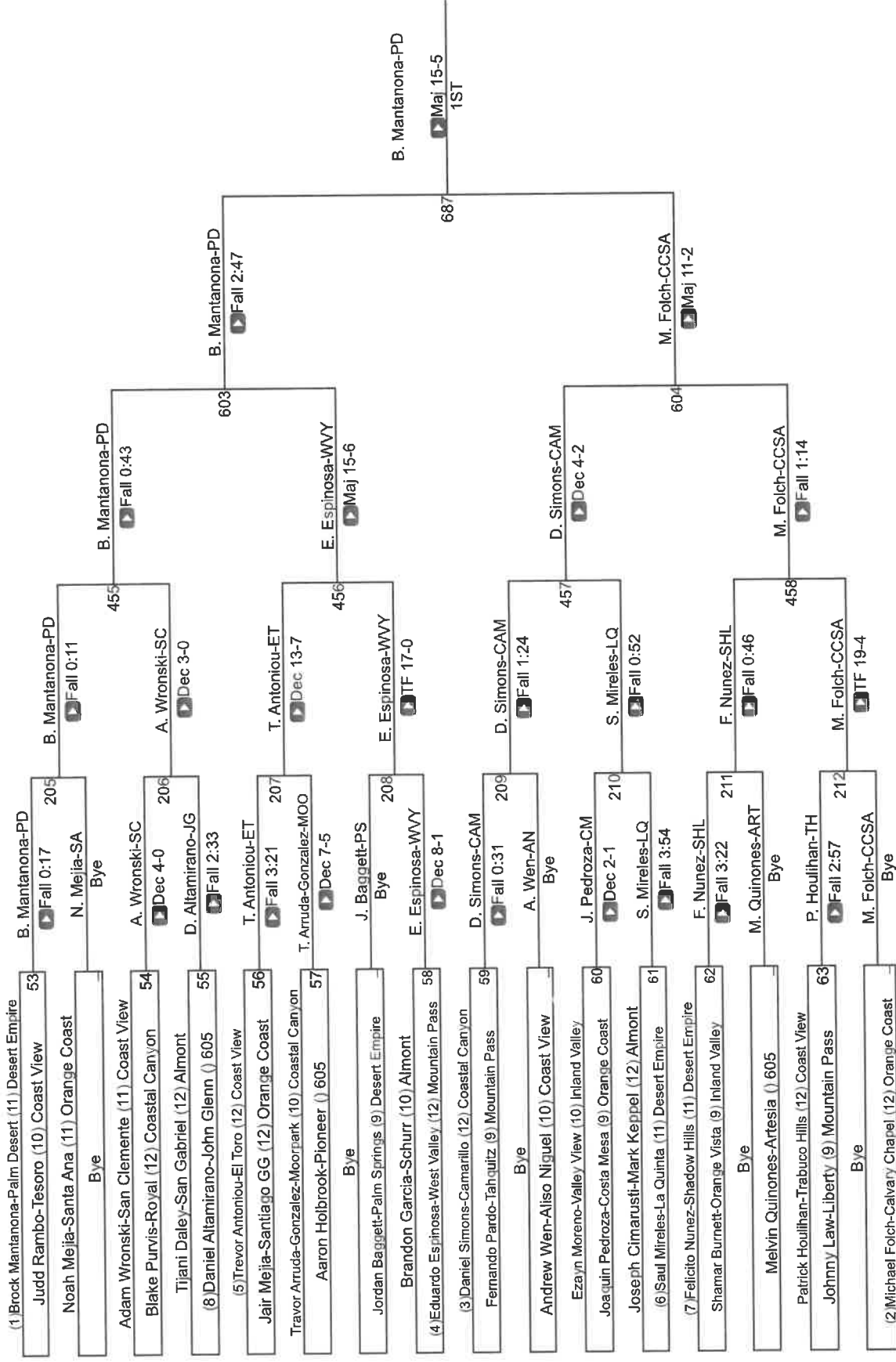

CIF Qualifier 138

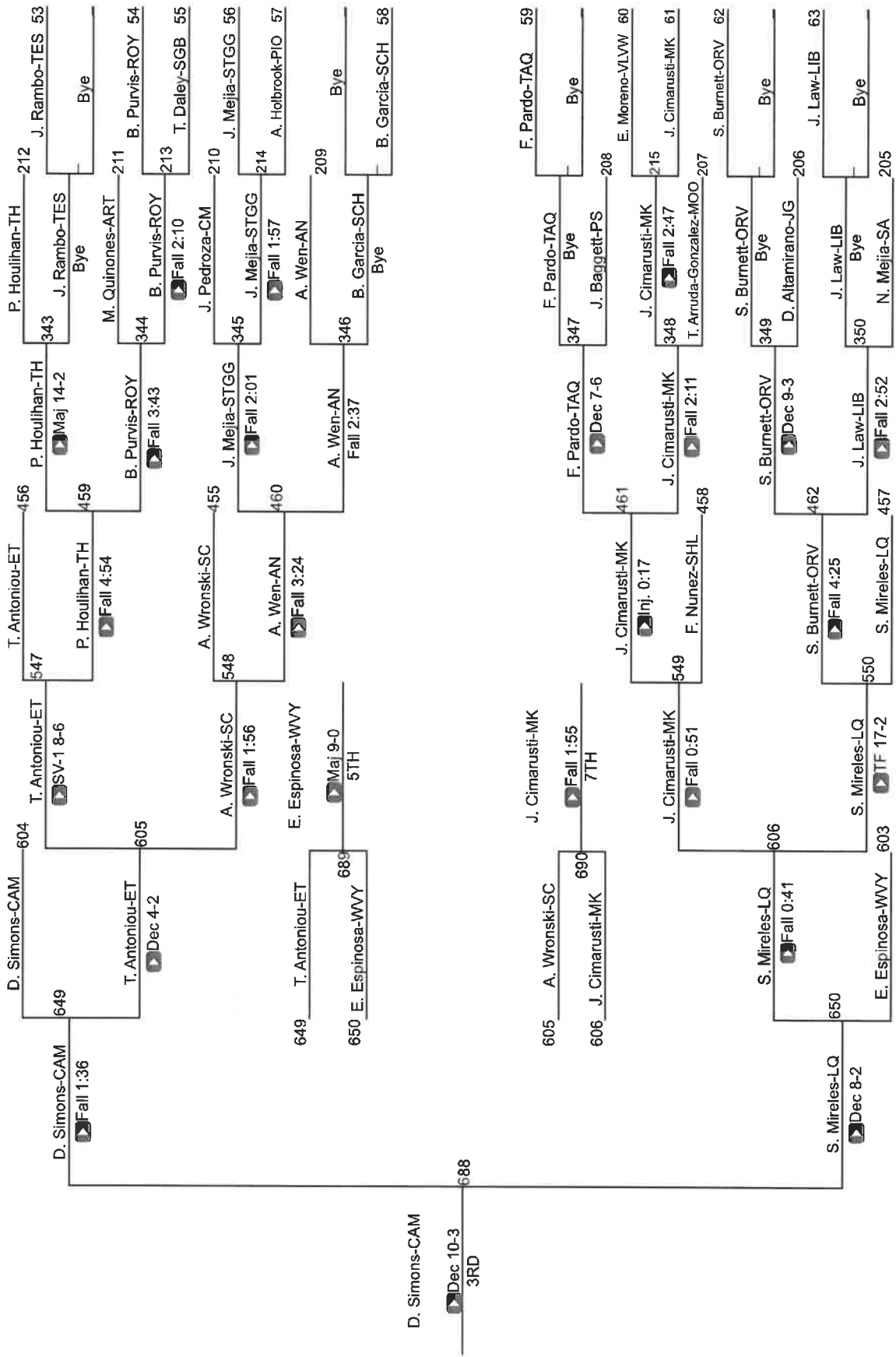

D. Simons-CAM

Dec 10-3
3RD

688

CIF SS Boys Individuals Eastern Div

CIF Qualifier 145

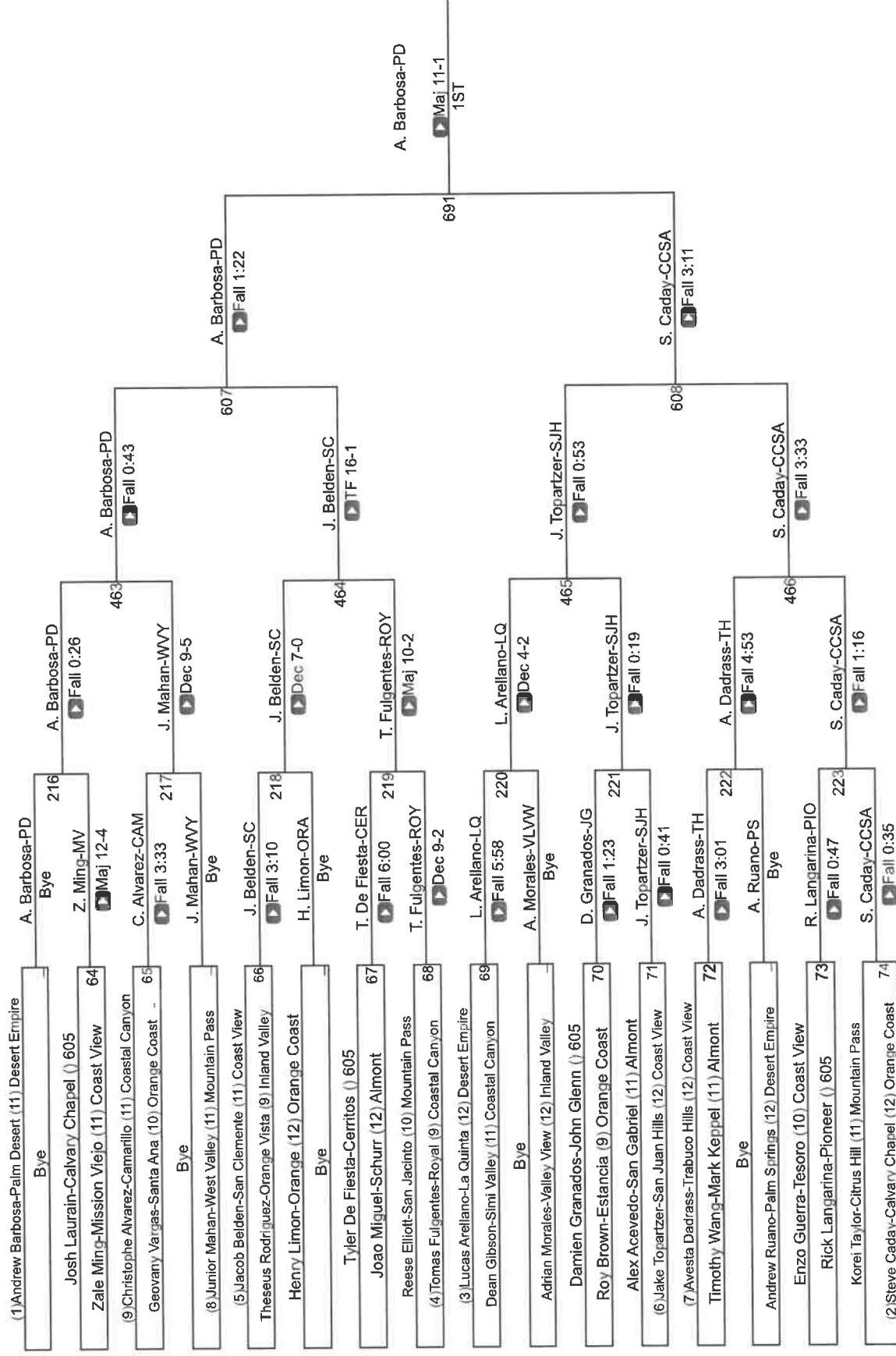

CIF SS Boys Individuals Eastern Div

CIF Qualifier 152

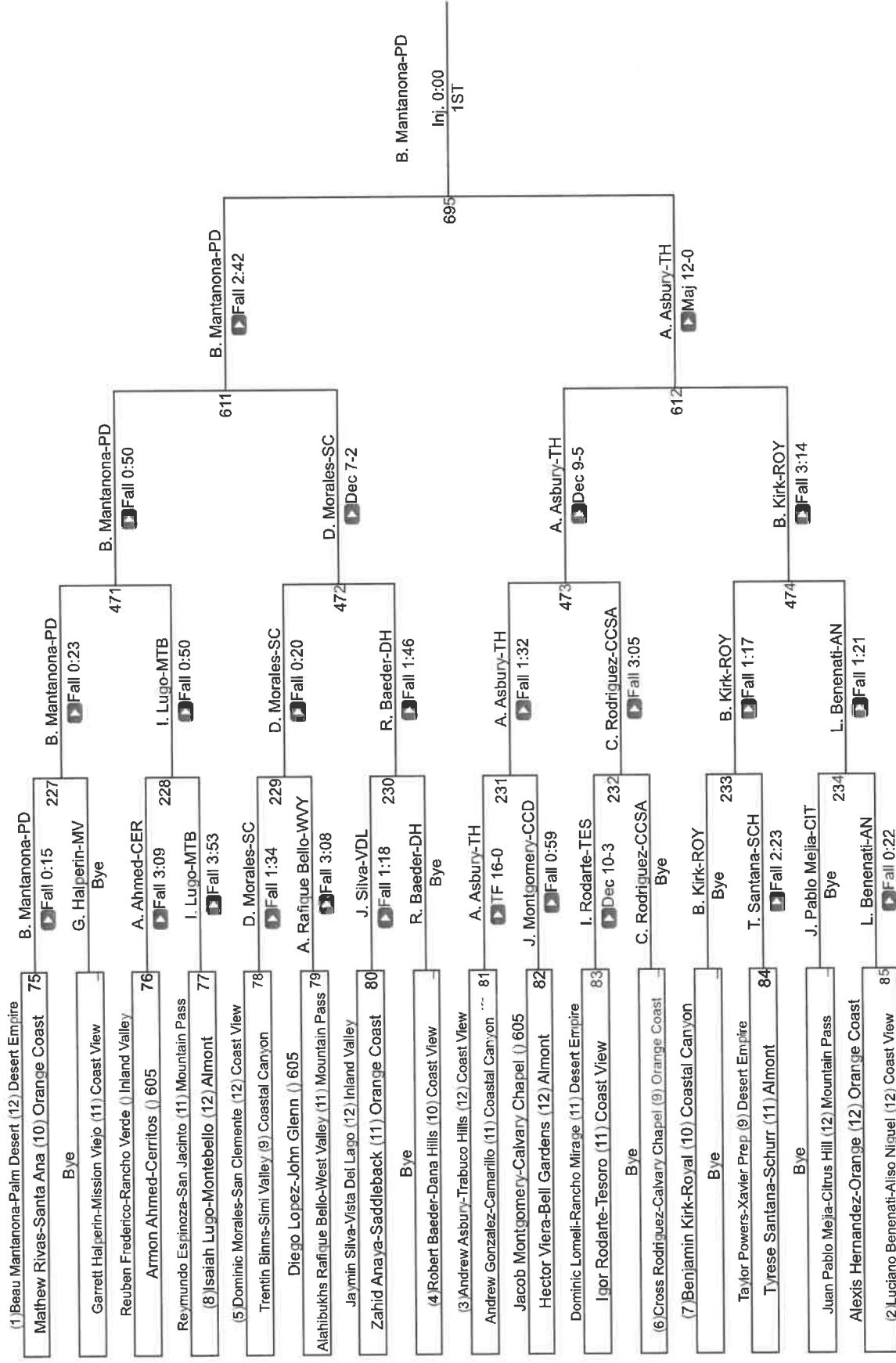

CIF Qualifier 152

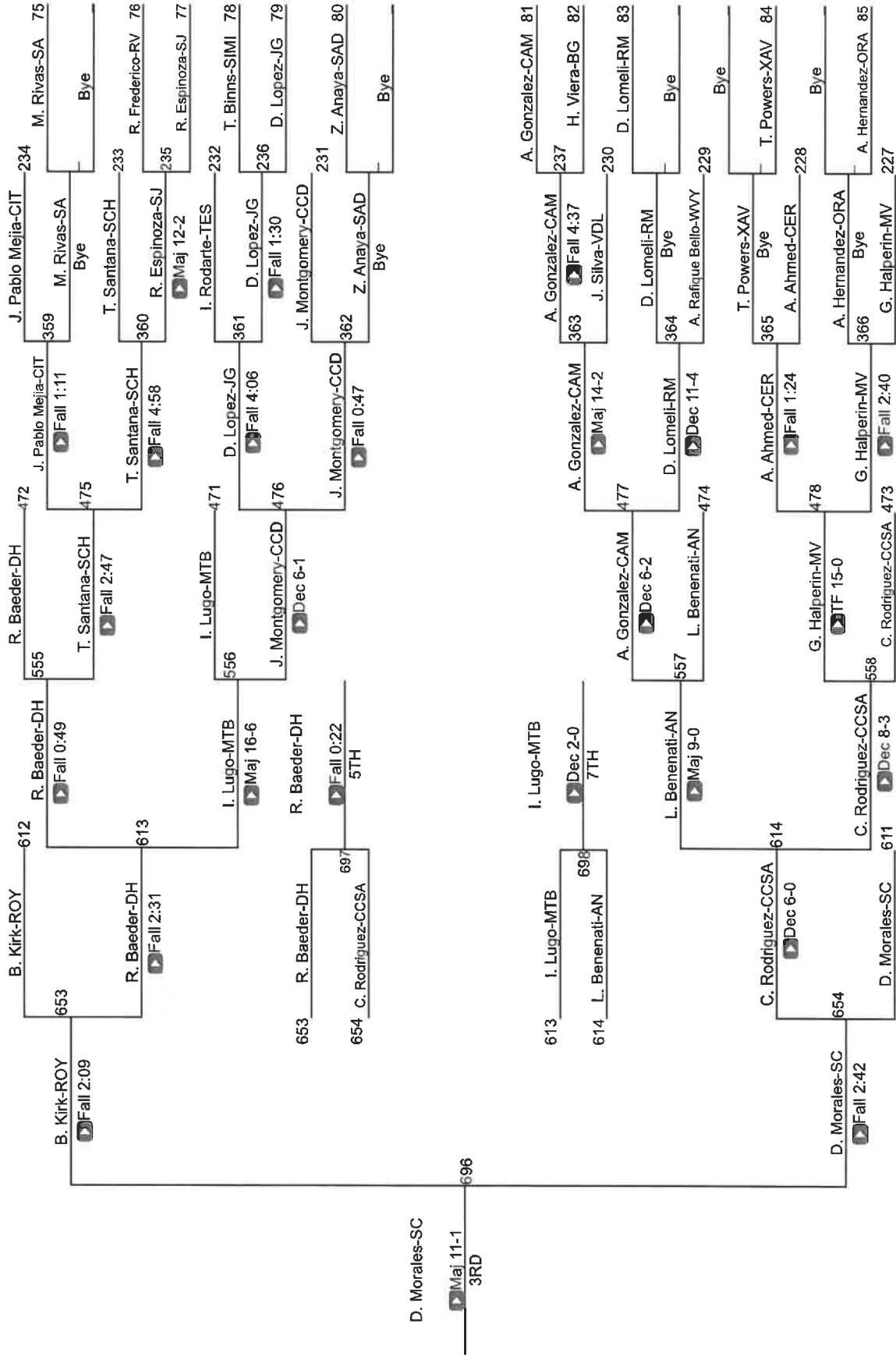

CIF SS Boys Individuals Eastern Div

CIF Qualifier 160

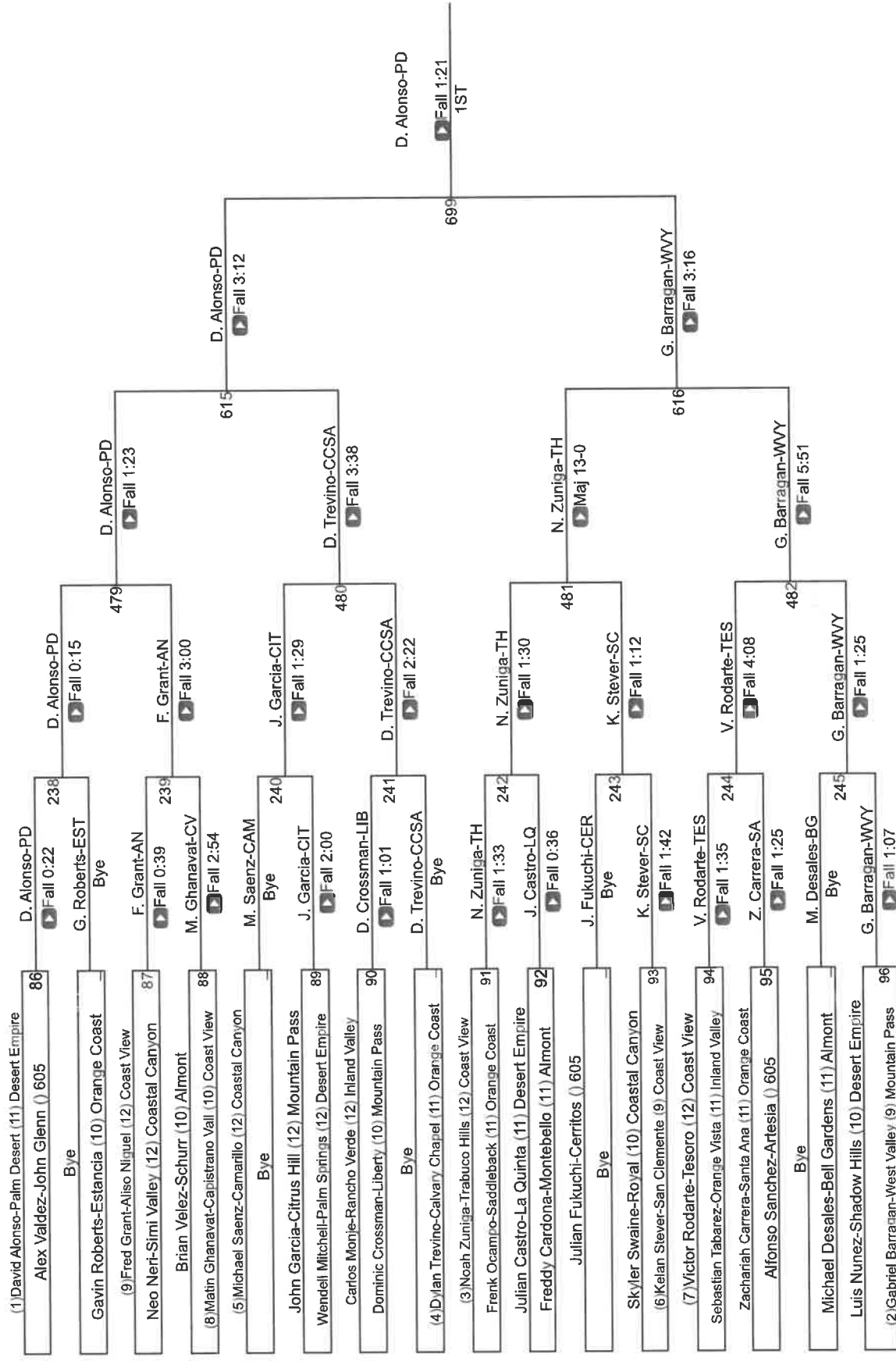

CIF Qualifier 160

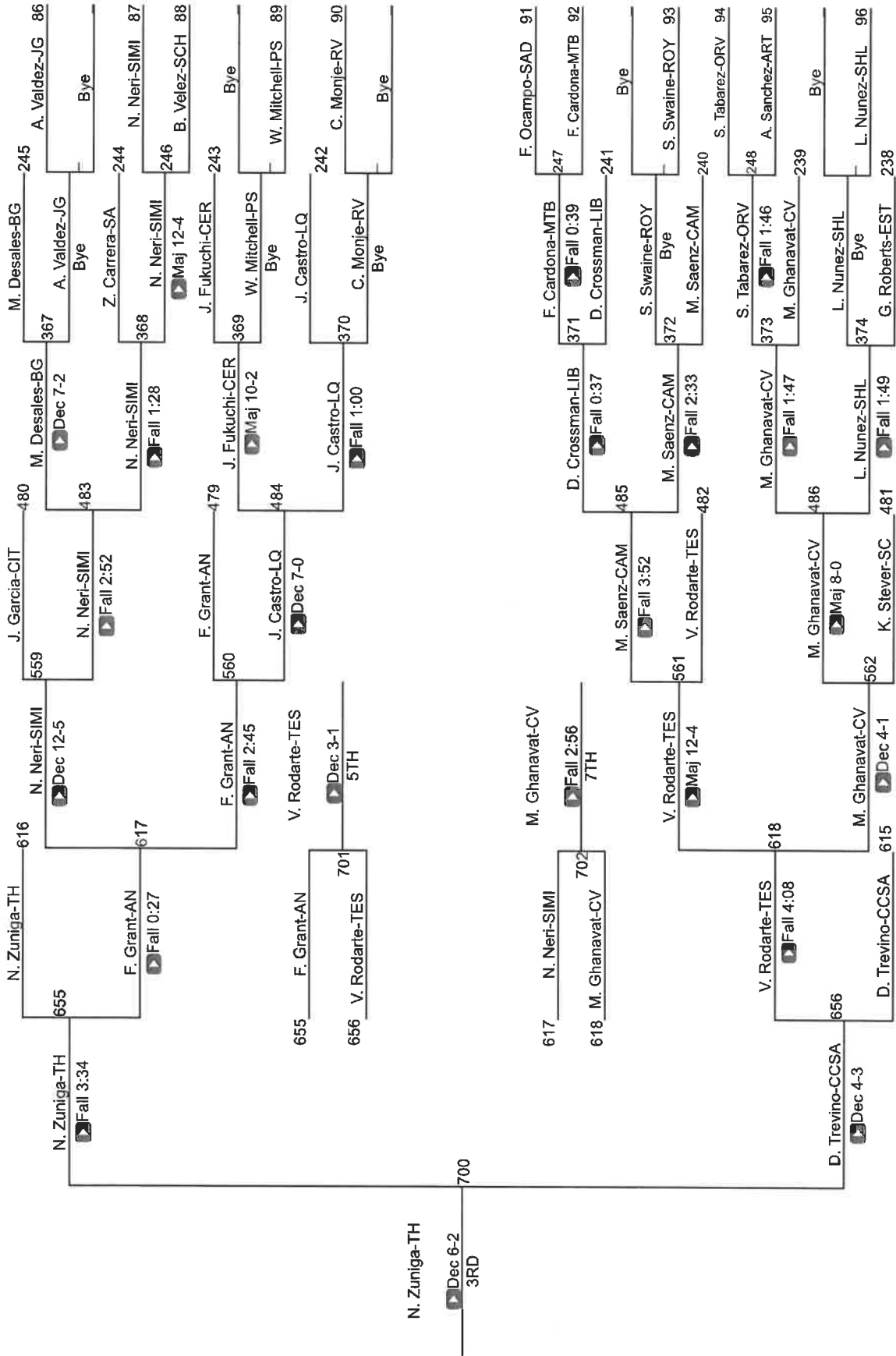

CIF SS Boys Individuals Eastern Div

CIF Qualifier 182

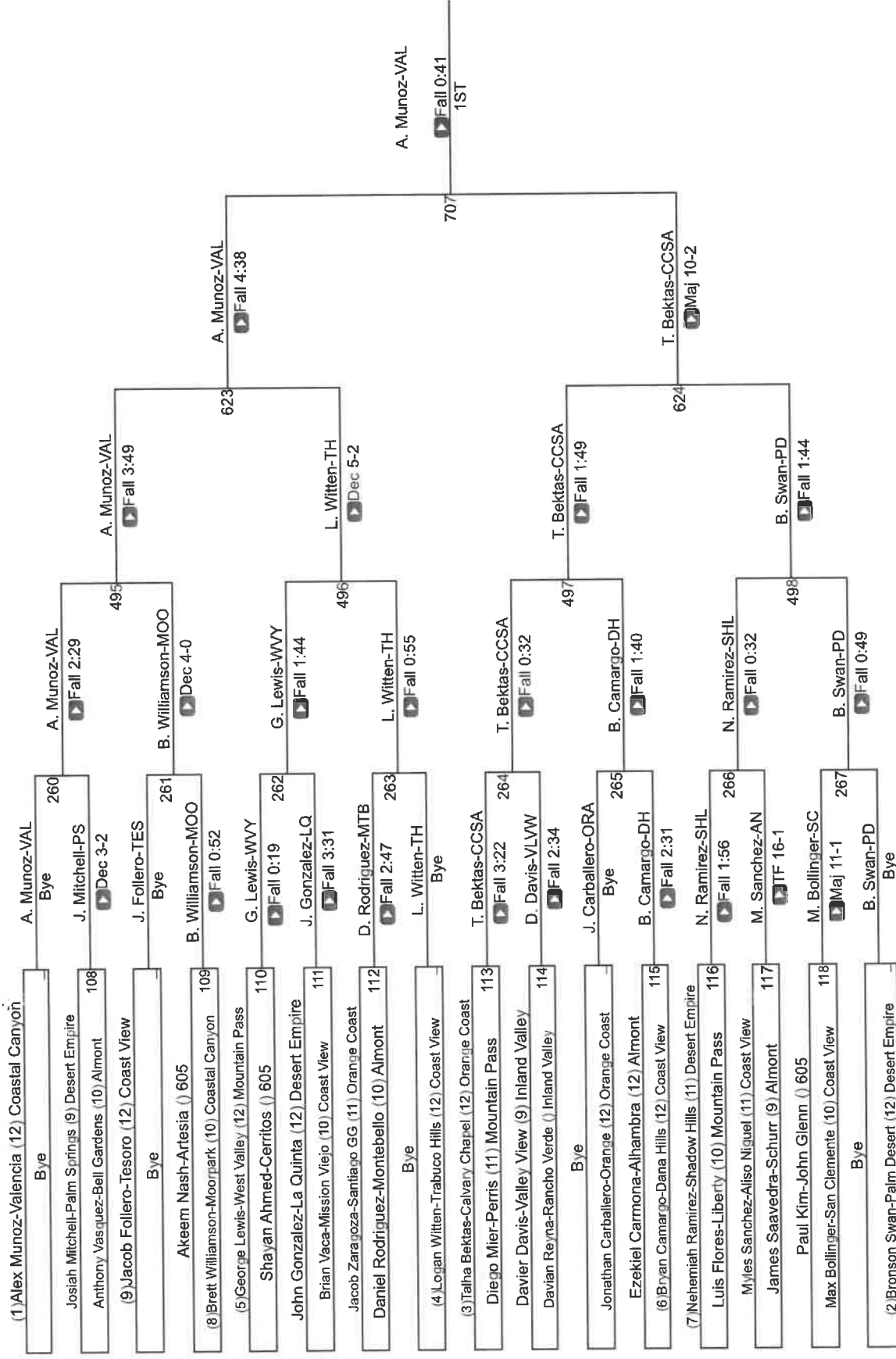

CIF SS Boys Individuals Eastern Div

CIF Qualifier 195

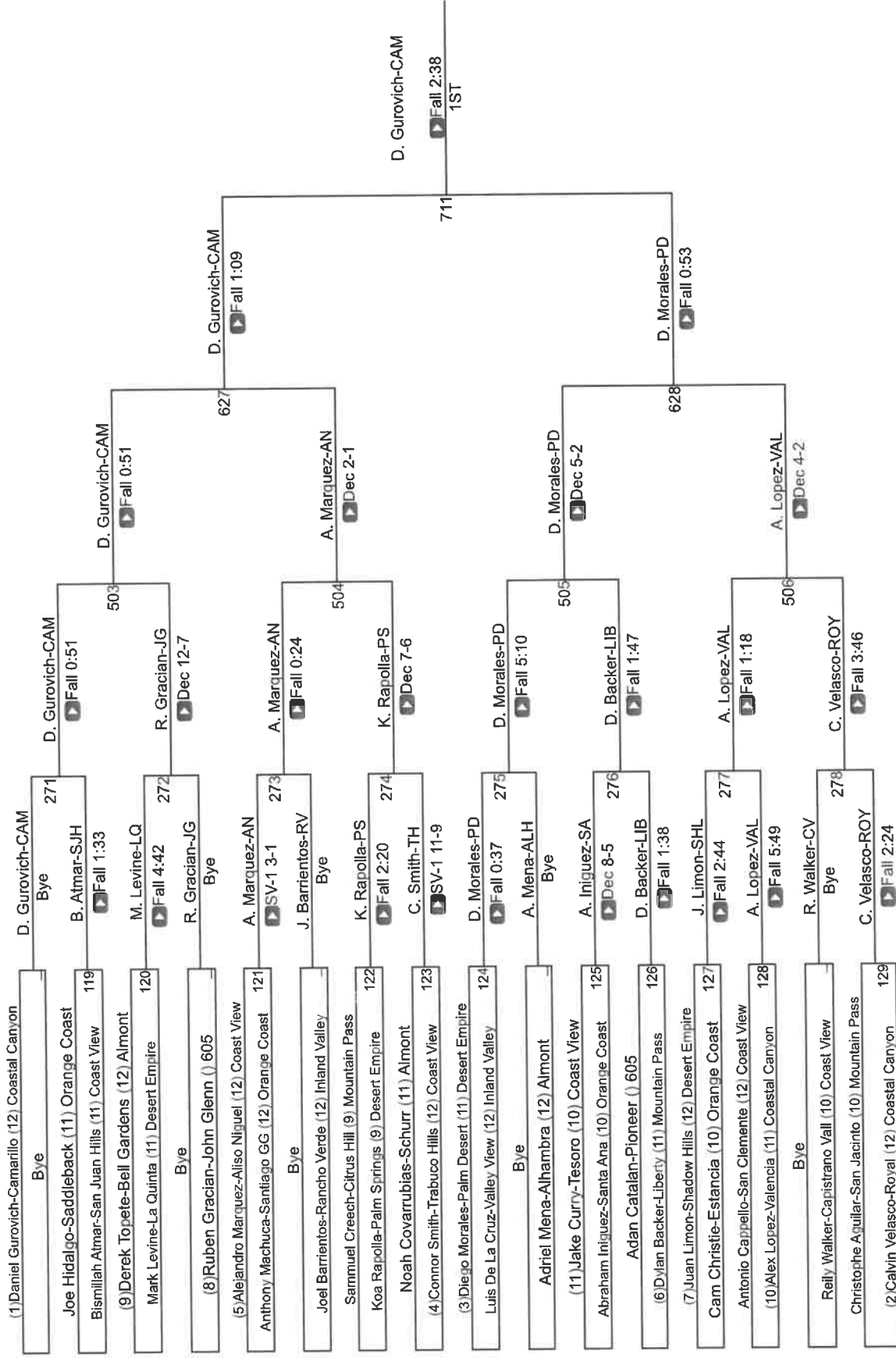

CIF Qualifier 195

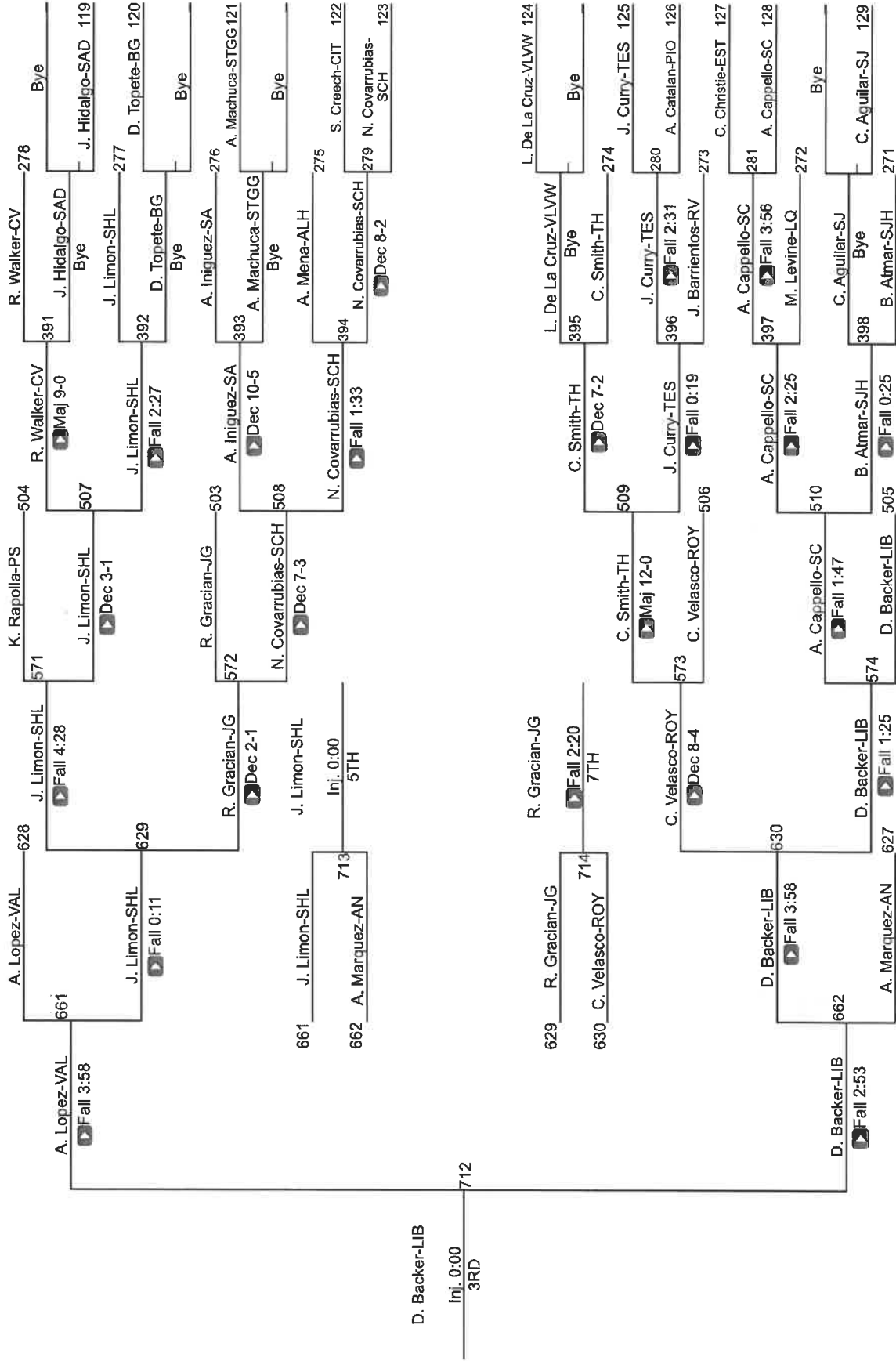

CIF SS Boys Individuals Eastern Div

CIF Qualifier 220

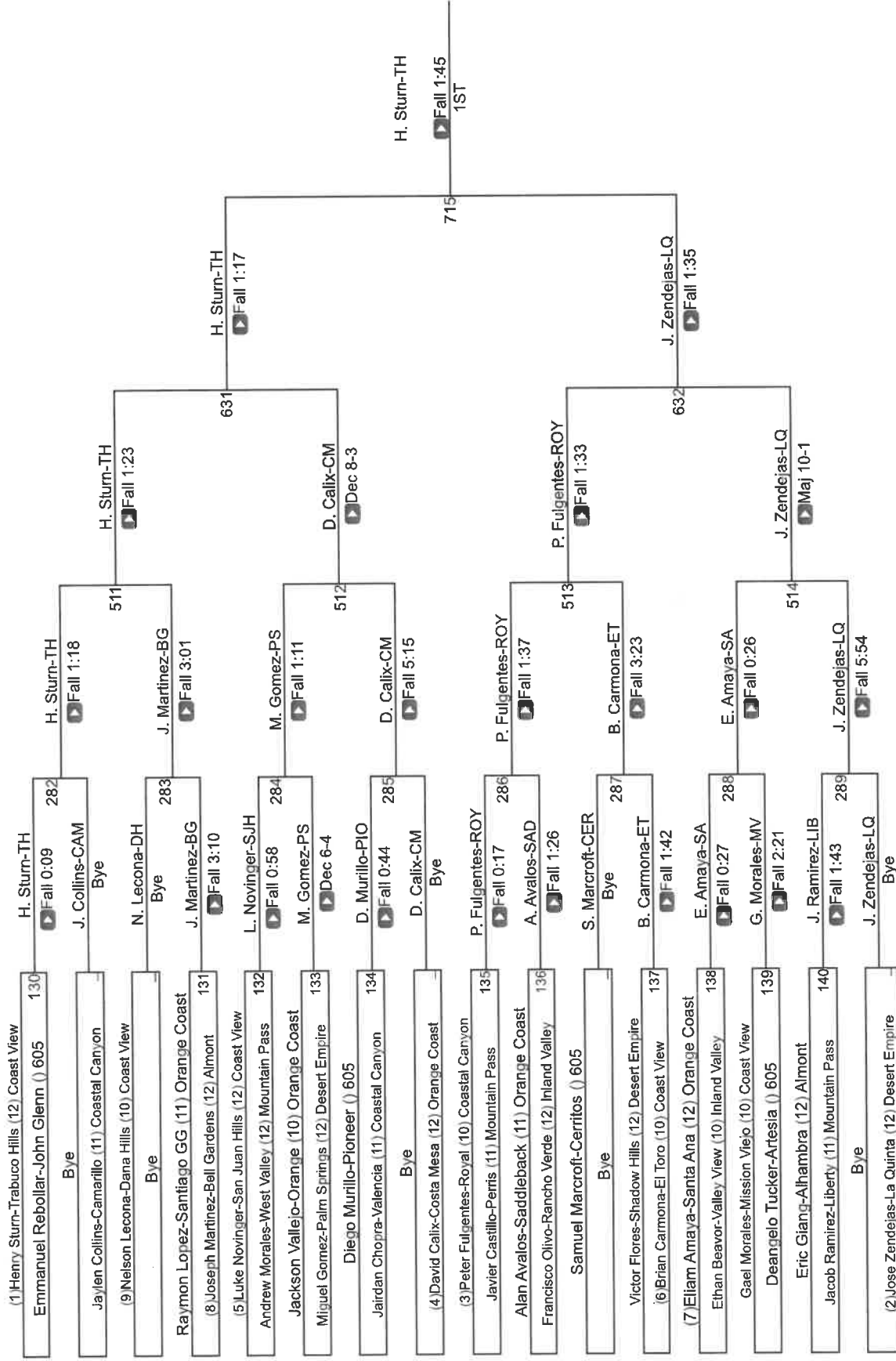

CIF Qualifier 220

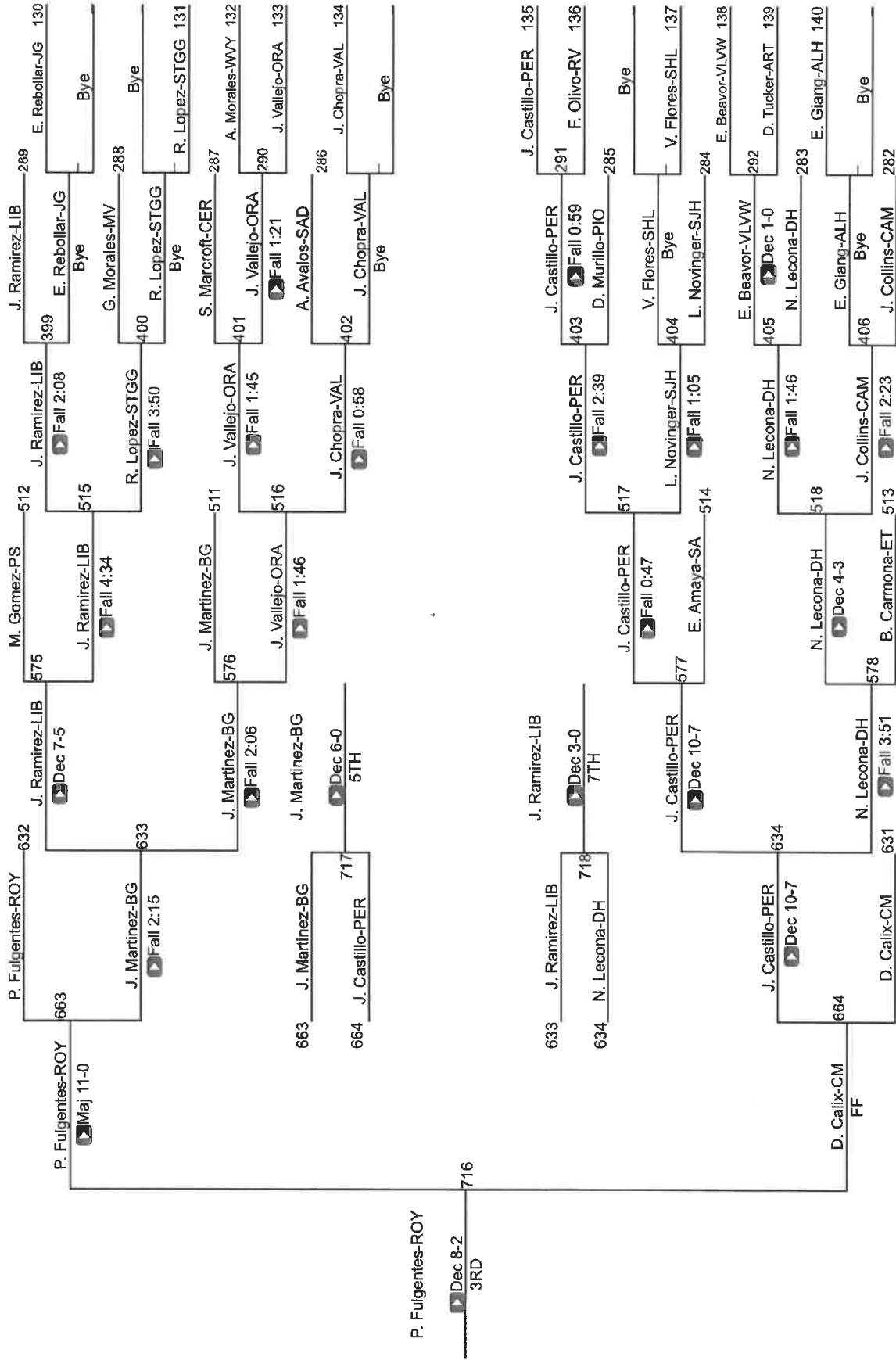

CIF SS Boys Individuals Eastern Div

CIF Qualifier 285

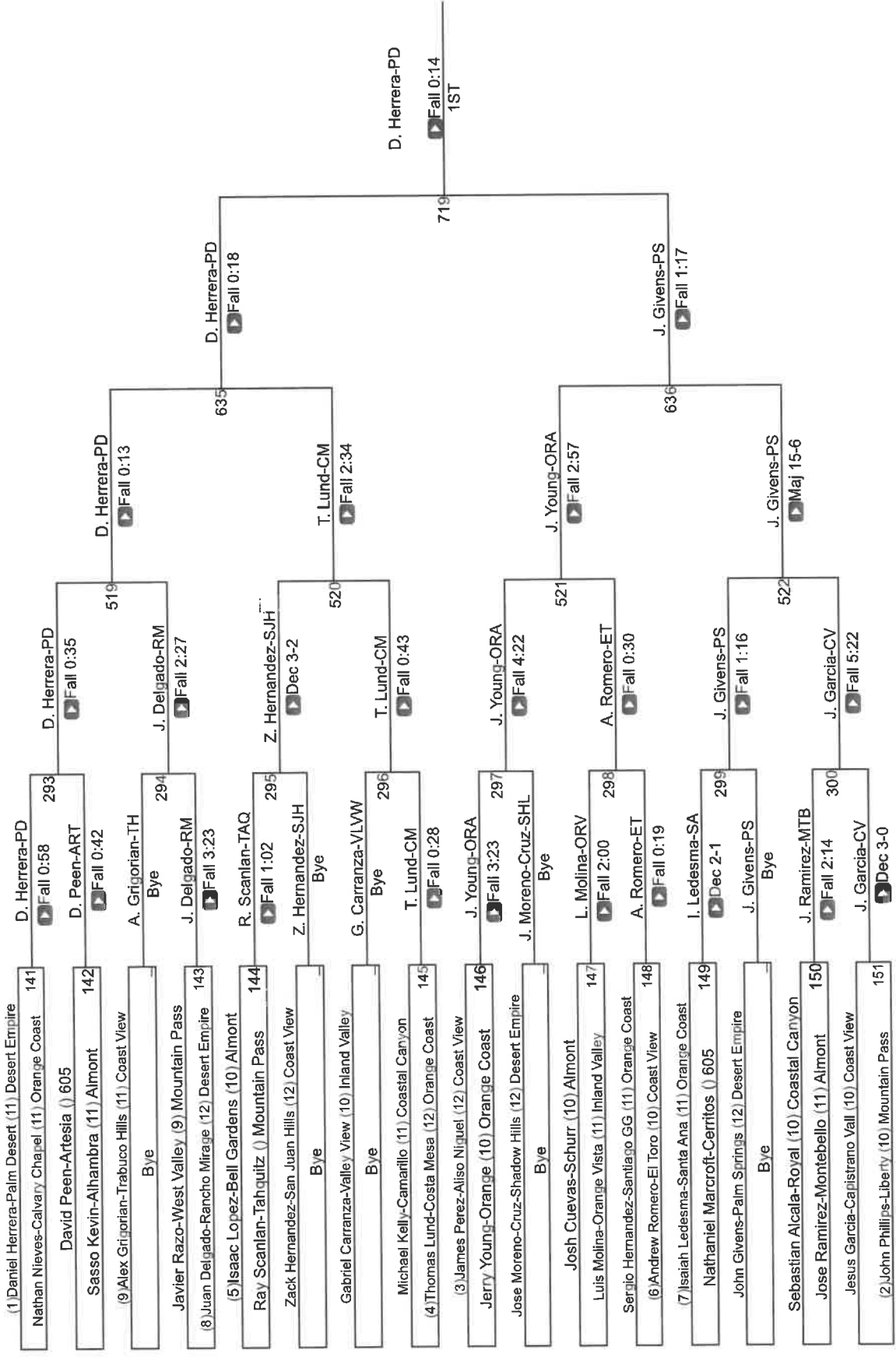

CIF Qualifier 285

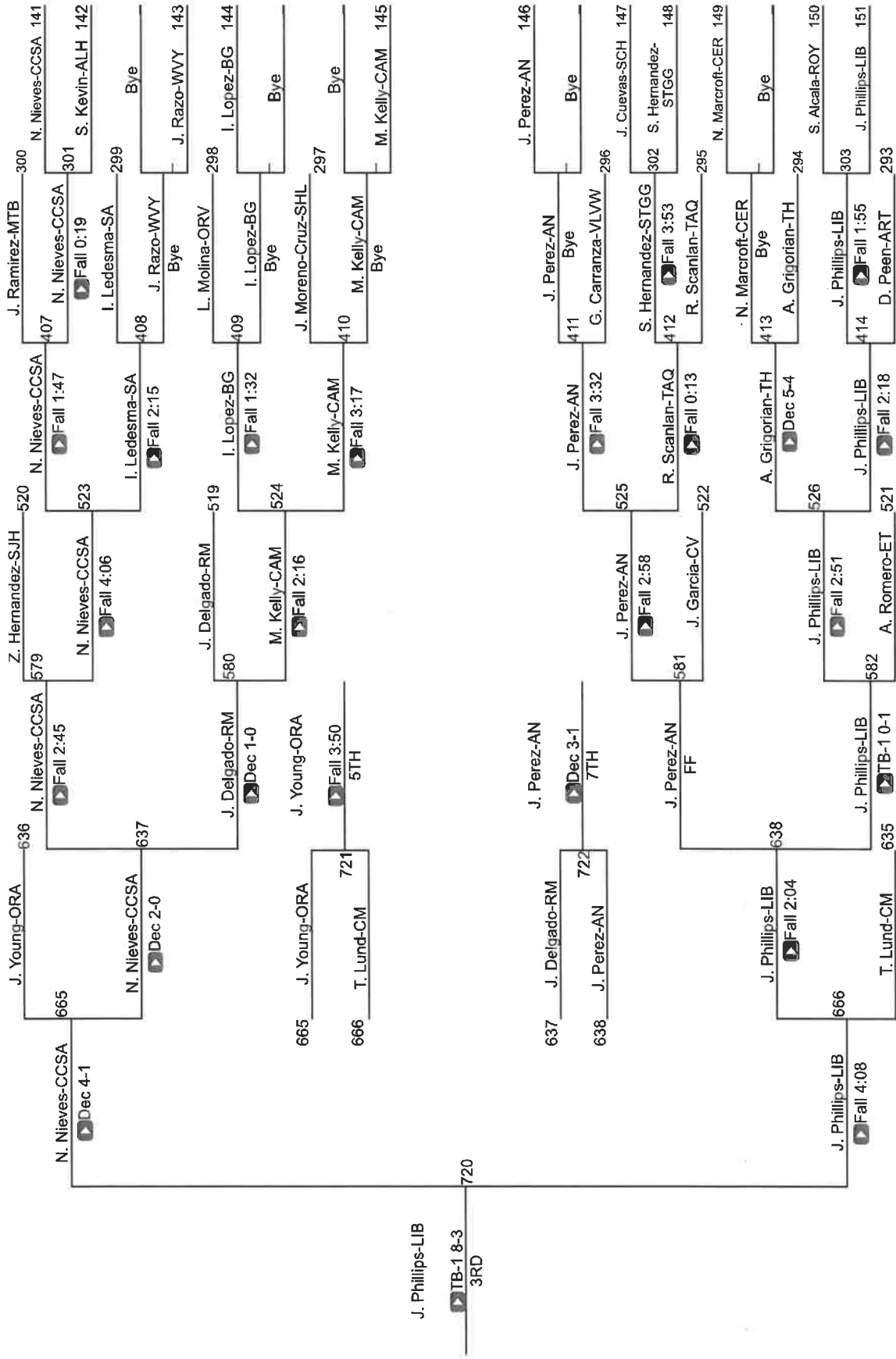

J. Phillips-LIB

TB-1 8-3
3RD

CIF SS Boys Individuals

Inland Division

Fountain Valley High School

February 10-11, 2023



Lower Weight MVP

Paulo Valdez
Hesperia
106 Pounds

Upper Weight MVP

Timothy McDonnell
Fountain Valley
182 Pounds

Placers

106 Pounds			152 Pounds			Team Score Final		
1st	Paulo Valdez	Hesperia	1st	Julian Jeong	Oak Hills	1	Fountain Valley	282
2nd	Rocky Humphrey	Sultana	2nd	Antonio Aramburu	Corona Del Mar	2	Hesperia	221
3rd	Hunter Jauregui	Fountain Valley	3rd	Nicholas Naranjo	Fountain Valley	3	Oak Hills	210.5
4th	Ethan Carey	Los Alamitos	4th	Danny Mattar	University	4	Corona Del Mar	174
5th	Micah Van Grol	Newport Harbor	5th	Cruz Duardo	Victor Valley	5	Victor Valley	160
6th	Lucas Long	Arroyo	6th	Amen Johnson	Laguna Hills	6	Newport Harbor	137.5
7th	Luke Miller	Corona Del Mar	7th	Tanner Nickelson	Beckman	7	Laguna Hills	111
8th	Michael Rodriguez	Victor Valley	8th	Marcos Nava	Barstow	8	Hillcrest	110.5
113 Pounds			160 Pounds			9	Sultana	100.5
1st	Anthony Lucio	Fountain Valley	1st	Zion Hernandez	Corona Del Mar	10	Arroyo	96
2nd	Adrian Jimenez	Marina	2nd	Dylan Bentz	Oak Hills	11	Irvine	93.5
3rd	Emiliano Hernandez	Hesperia	3rd	Giovanni Dantas	Beckman	12	Marina	82.5
4th	Angelo Gonzalez	Corona Del Mar	4th	Frankie Stevenson	Hesperia	13	Serrano	77.5
5th	Mekhi Yanthis	Los Alamitos	5th	Tommy Barrales	South El Monte	14	Los Alamitos	76
6th	Elijah Garcia	Apple Valley	6th	Gavin Yager	Fountain Valley	15	Beckman	68
7th	Barron Zepeda	Laguna Beach	7th	Jacob Moreo	Los Alamitos	16	Laguna Beach	59
8th	Damian Fajardo	Laguna Hills	8th	Mark Sterbenz	Sultana	17	Apple Valley	51.5
120 Pounds			170 Pounds			18	Ramona	44
1st	Hector Hernandez	Hesperia	1st	Khale McDonnell	Fountain Valley	19	Woodbridge	43
2nd	Syrus Singh	Laguna Hills	2nd	Blake Chaffee	Serrano	20	Edison	39
3rd	Demian Pryma	Newport Harbor	3rd	Beni Magyar	Irvine	21	Patriot	37
4th	Jeremiah Herrington	Irvine	4th	Brodrick Foster	Hillcrest	22	Northwood	29.5
5th	Bach Le	Edison	5th	Jose Rodriguez	Victor Valley	23	Adelanto	28
6th	Jack Karson	Beckman	6th	Brayden Green	Burroughs	24	South El Monte	28
7th	Brent Cannon	Serrano	7th	John Mancera	Oak Hills	25	University	28
8th	Dylann Ruiz	Los Alamitos	8th	Hudson Sweitzer	Trinity Classical Academy	26	Barstow	27
126 Pounds			182 Pounds			27	Granite Hills	26
1st	Haden Hernandez	Marina	1st	Timothy McDonnell	Fountain Valley	28	Big Bear	25
2nd	Caleb Wheeler	Newport Harbor	2nd	Jeremy Kanter	Laguna Beach	29	Gabrielino	22
3rd	Andrew Diaz	Hesperia	3rd	Shea Gabriel	Oak Hills	30	Burroughs	18.5
4th	Kamron Yamada	Oak Hills	4th	Jesse Cardona	Victor Valley	31	Huntington Beach	18
5th	Samuel Yokoyama	Los Alamitos	5th	David Grannis-Vu	Northwood	32	Excelsior Charter	15
6th	Denzel Cisneros	Sultana	6th	Luis Fidencio	Hillcrest	33	Marshall	13
7th	Luke LaLonde	Edison	7th	Zack Leon	Apple Valley	34	Trinity Classical Academy	10
8th	Brandon Chiang	Irvine	8th	Ryan Garcia	Hesperia	35	Norte Vista	9
132 Pounds			195 Pounds			36	Arlington	6
1st	Evan Roy	Hesperia	1st	Ryland Whitworth	Fountain Valley	37	Portola	5
2nd	Finnegan Long	Arroyo	2nd	Eugenio Fierro	Corona Del Mar	38	Rosemead	5
3rd	Loscar Riestra	Corona Del Mar	3rd	Joseph Traney	Irvine	39	El Monte	4
4th	Gavin Stephens	Huntington Beach	4th	Jacob Hernandez	Oak Hills	40	Silver Valley	4
5th	Thomas Jablonski	Sultana	5th	Achilles Violette	Patriot	41	Silverado	4
6th	Matthew Plinon	Newport Harbor	6th	Diego Garcia	Barstow	42	Mountain View	3
7th	Jaden Reid	Fountain Valley	7th	Alejandro Reyes	Arroyo	43	La Sierra	0
8th	Nikita Sipachev	Laguna Hills	8th	Steve Chavez	Victor Valley	44	Lucerne Valley	0
138 Pounds			220 Pounds					
1st	Hercules Windrath	Fountain Valley	1st	Gabriel Chavez	Hillcrest			
2nd	Matthias Valdez	Hesperia	2nd	Charles King	Oak Hills			
3rd	Aaron Ramirez	Victor Valley	3rd	Makoa McCreadie	Woodbridge			
4th	Zach Chacon	Laguna Hills	4th	Anthony DeLeon	Serrano			
5th	John Strapp	Corona Del Mar	5th	Tony Leon	Corona Del Mar			
6th	Jayden Autry	Granite Hills	6th	Xander Firm	Sultana			
7th	Ryan Collins-Kruger	Sultana	7th	Caine Elroy	Fountain Valley			
8th	Armaan Nikoo	Irvine	8th	Aaron Duran	Arroyo			
145 Pounds			285 Pounds					
1st	Anthony Manno	Newport Harbor	1st	Angel Fuentes	Ramona			
2nd	Dominic Tamayo	Oak Hills	2nd	Dylan Bunbury	Fountain Valley			
3rd	Avian Singh	Victor Valley	3rd	Anthony Ruiz	Hesperia			
4th	Shane A. Lerma	Marina	4th	Subedei Temuujin	Woodbridge			
5th	Aiden Tak	Northwood	5th	Angel Morales	Victor Valley			
6th	Larry Cruz	Arroyo	6th	John Downing	Adelanto			
7th	James Kurcz	Corona Del Mar	7th	Roger Sanchez	Arroyo			
8th	Isaiah Burney	Fountain Valley	8th	Everett Heninger	Newport Harbor			

CIF SS Boys Individuals Inland Div

CIF Qualifier 106

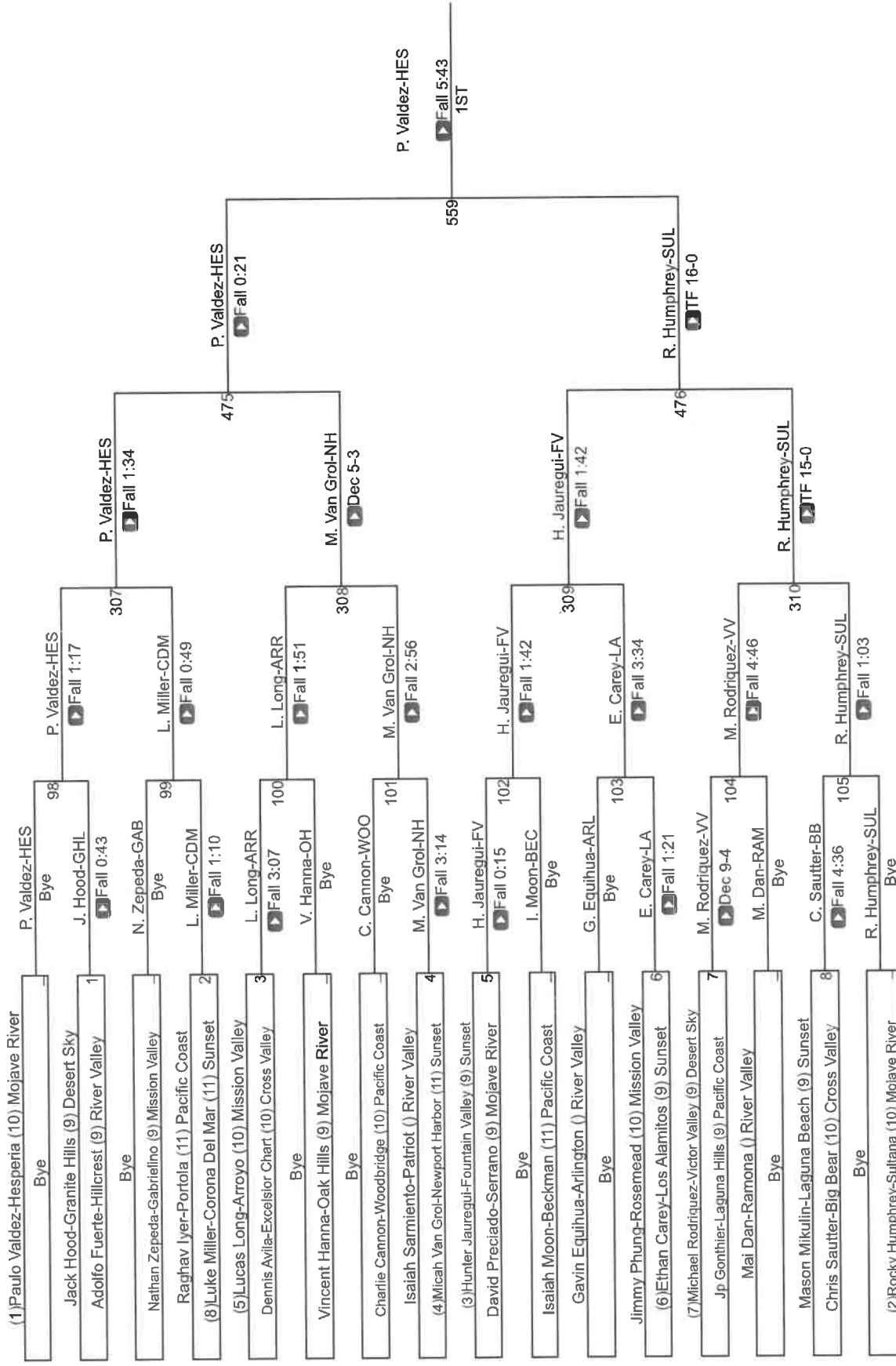

CIF SS Boys Individuals Inland Div

CIF Qualifier 113

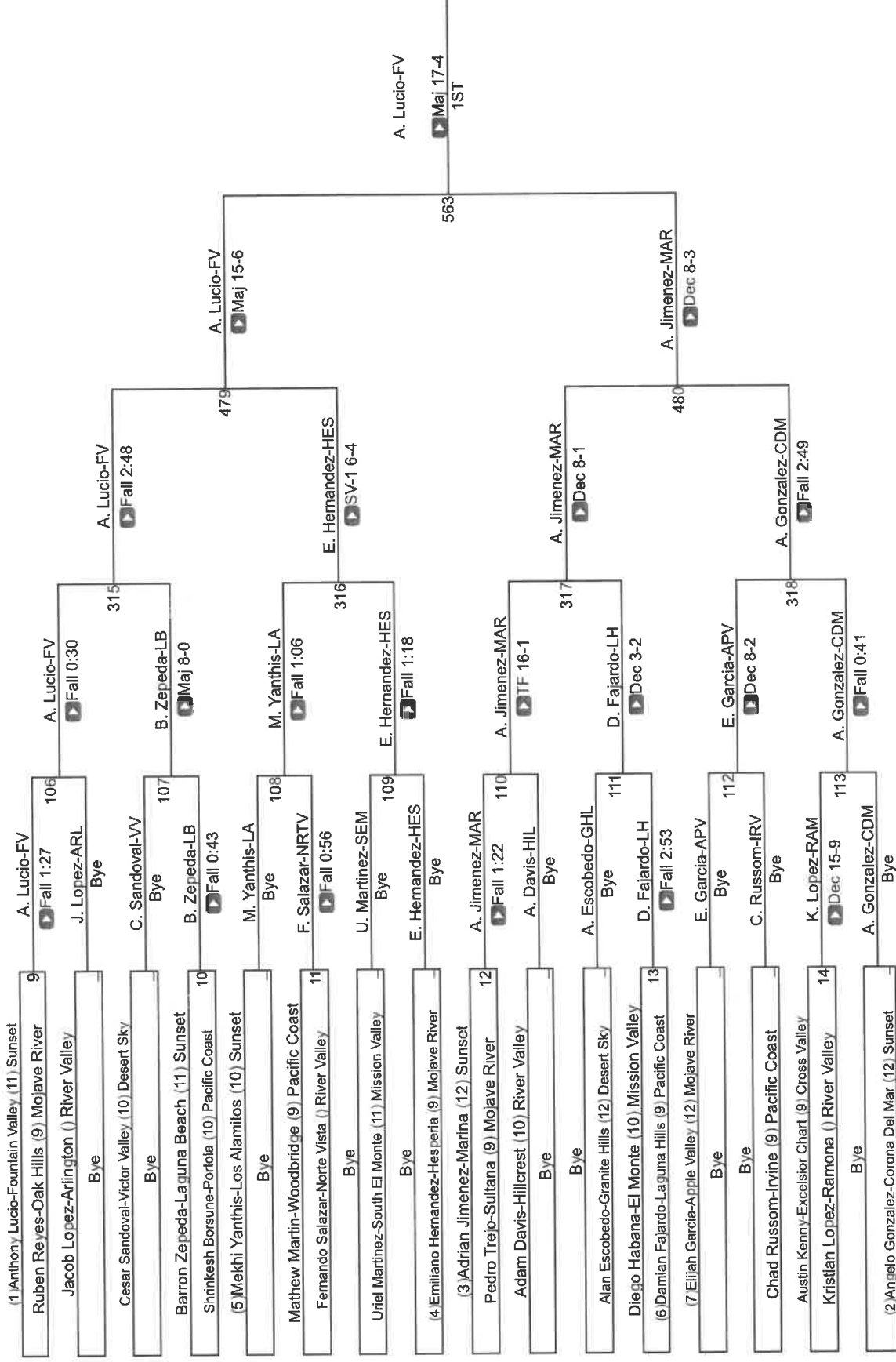

CIF SS Boys Individuals Inland Div

CIF Qualifier 120

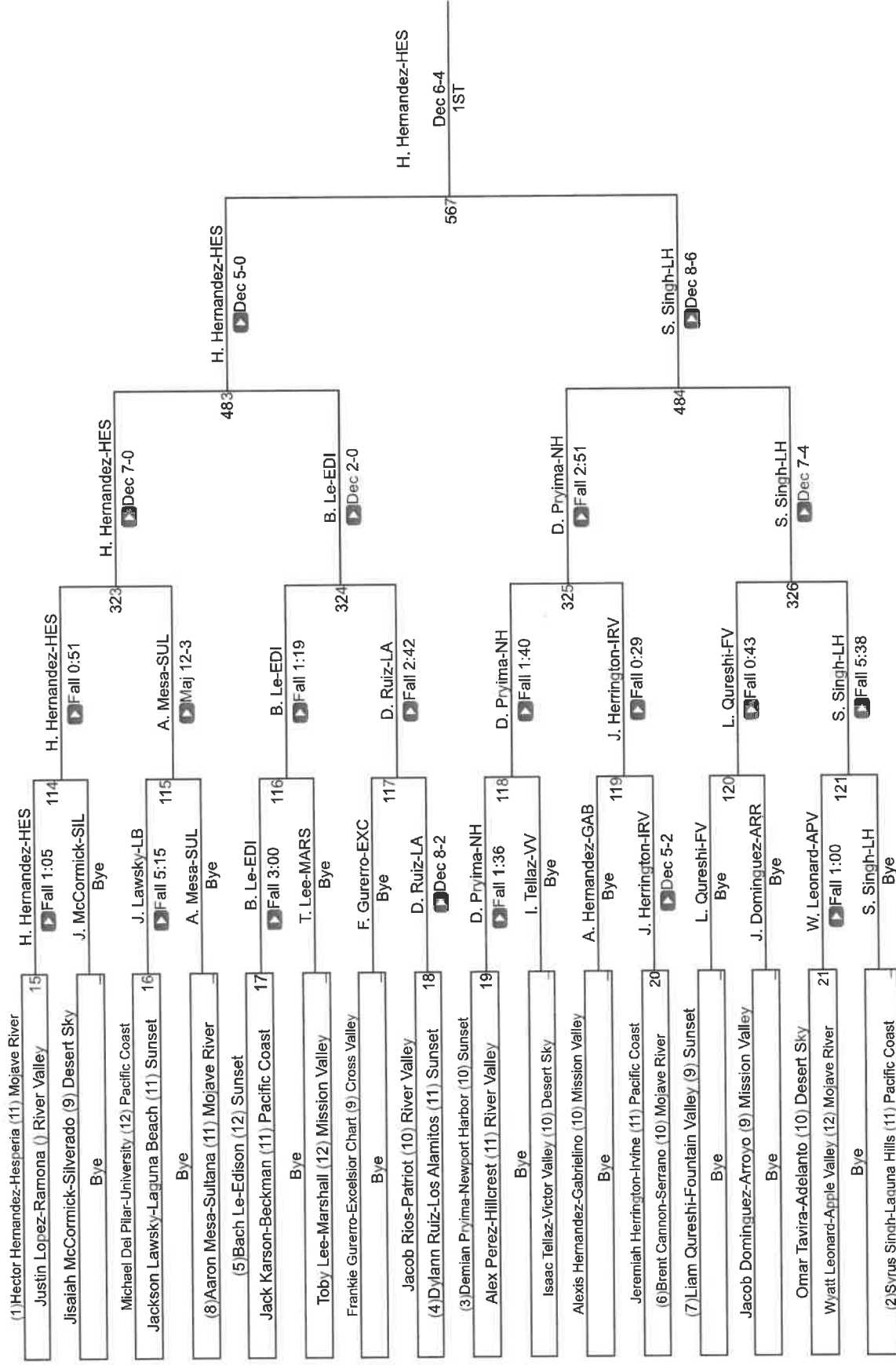

CIF SS Boys Individuals Inland Div

CIF Qualifier 126

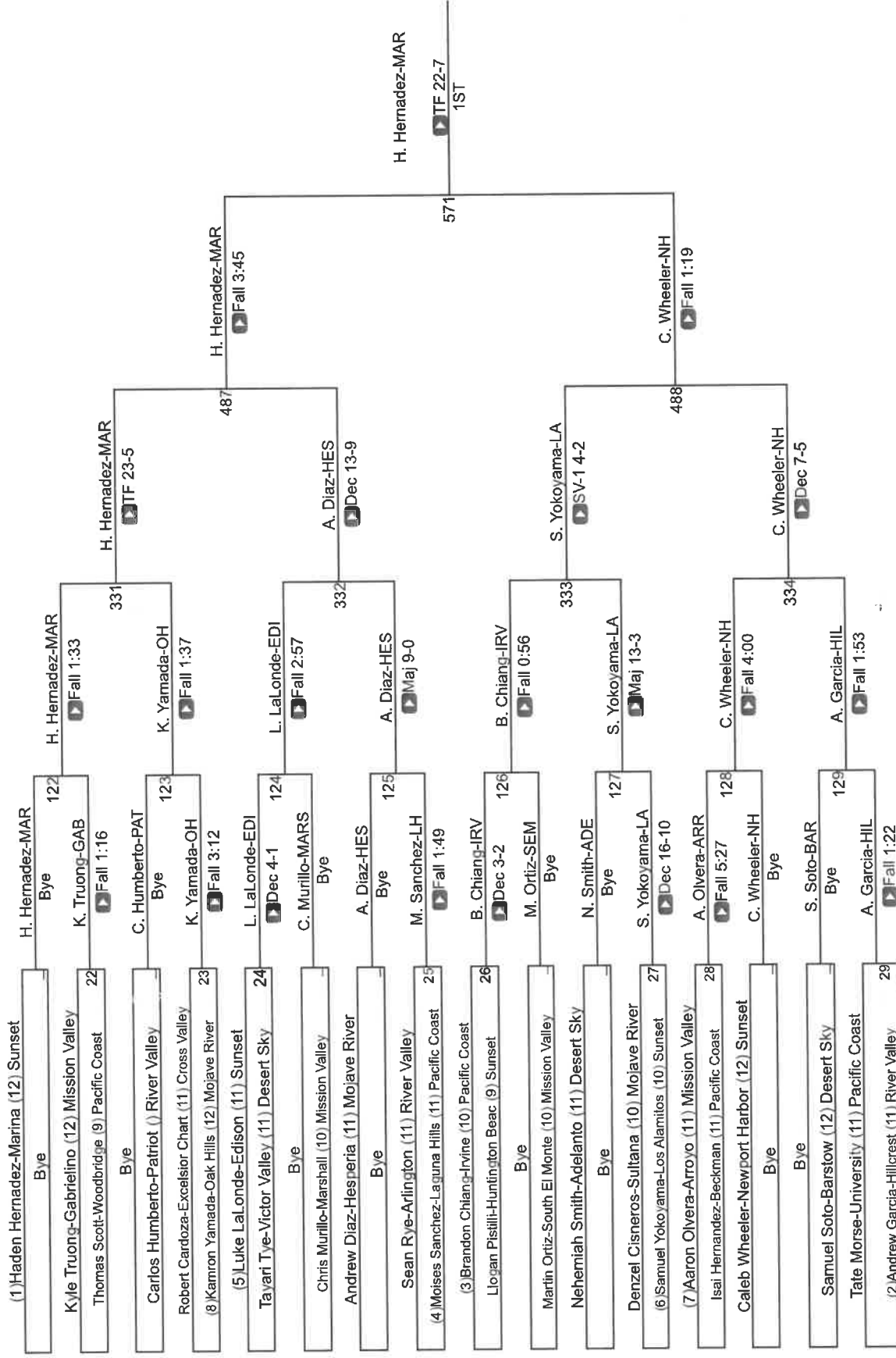

CIF SS Boys Individuals Inland Div

CIF Qualifier 132

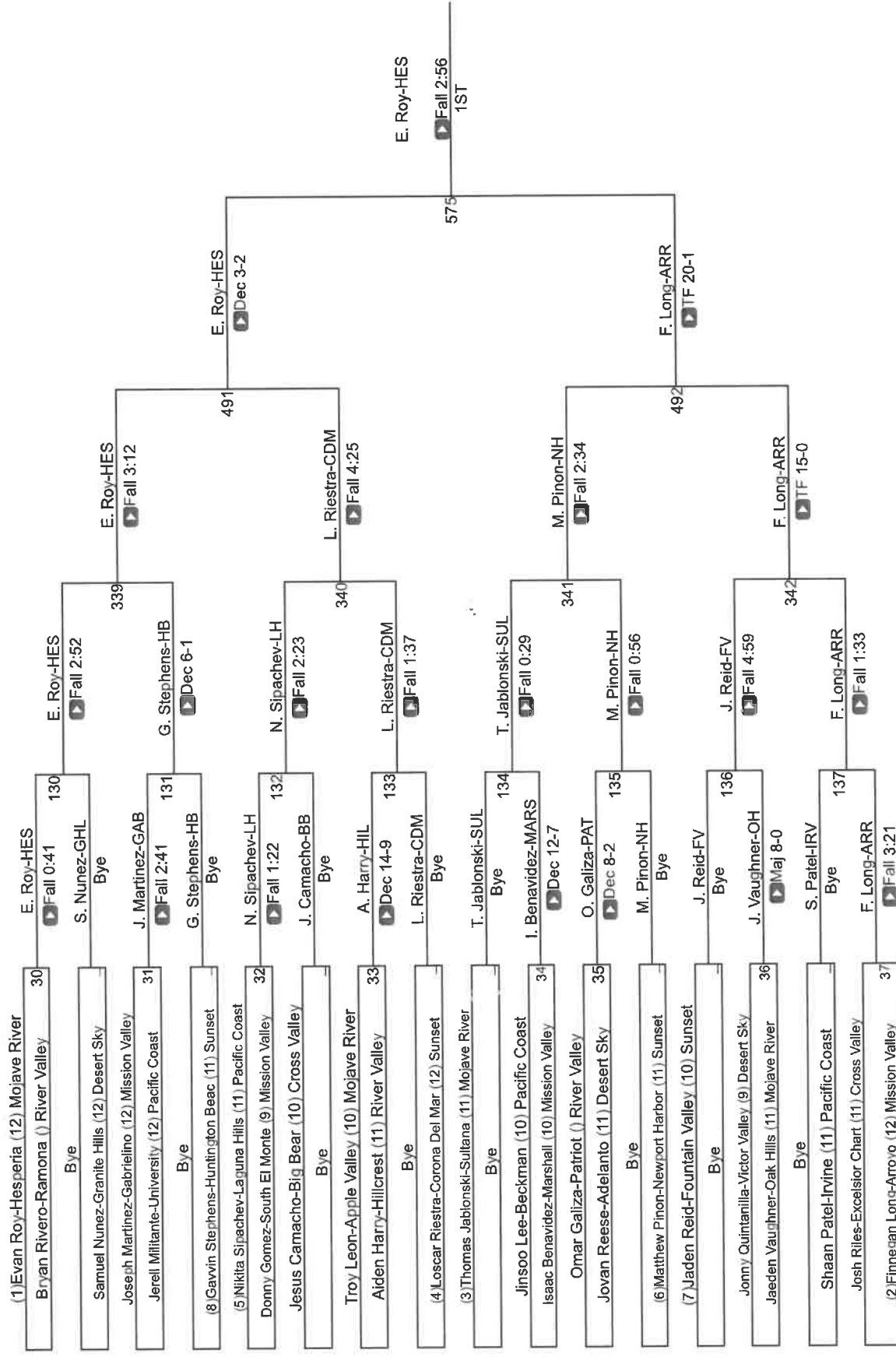

CIF SS Boys Individuals Inland Div

CIF Qualifier 138

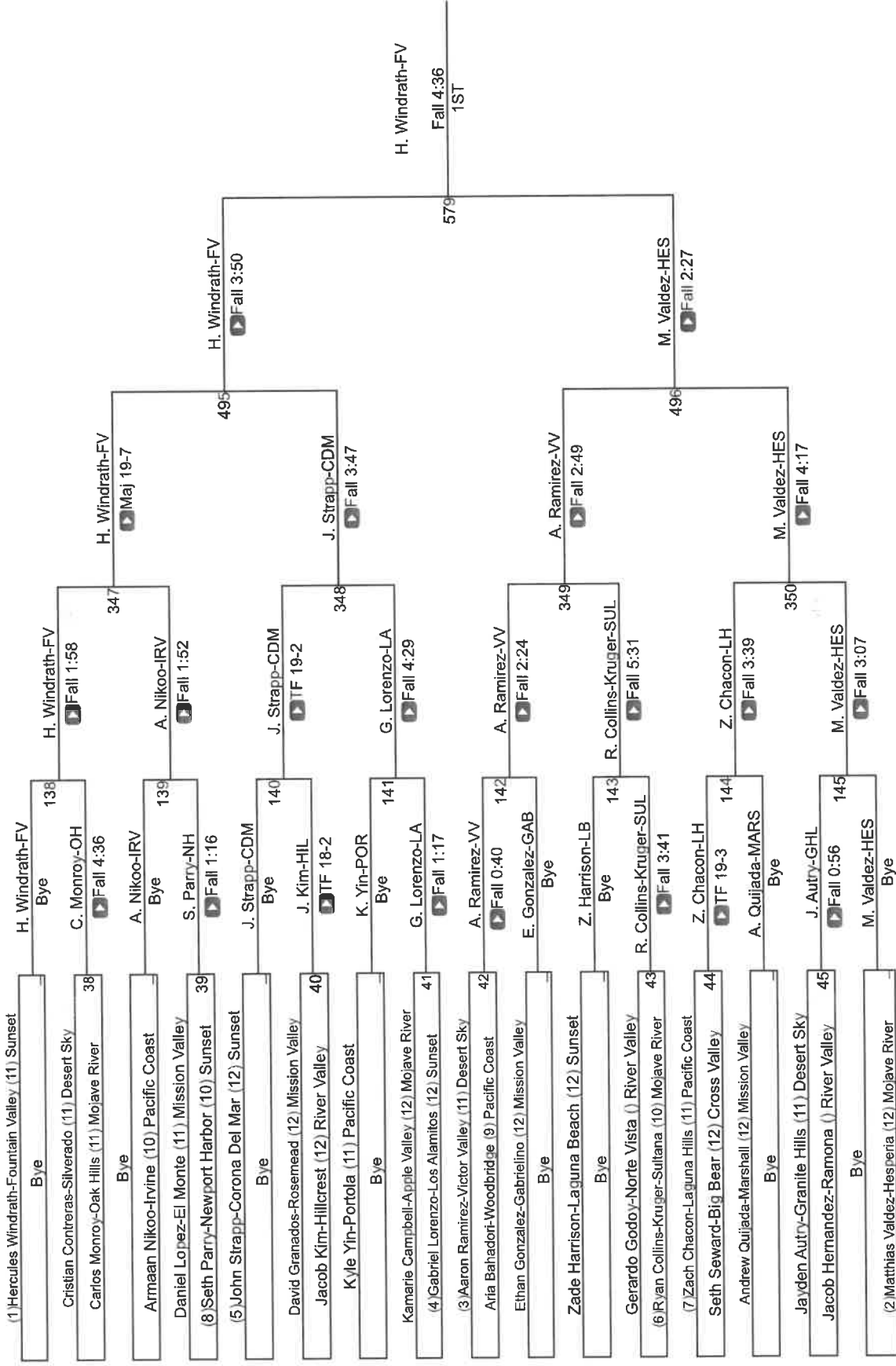

CIF SS Boys Individuals Inland Div

CIF Qualifier 145

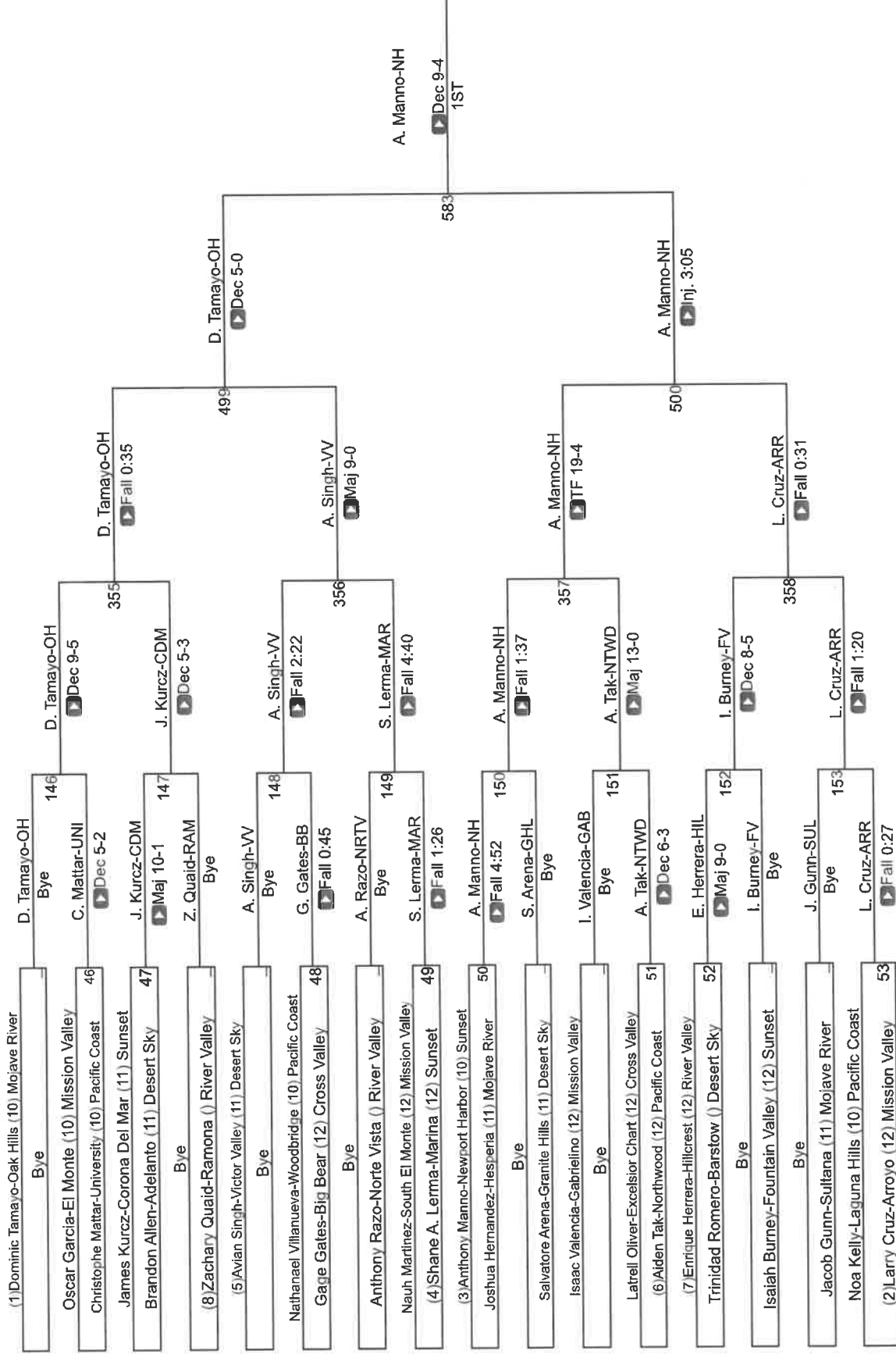

CIF Qualifier 145

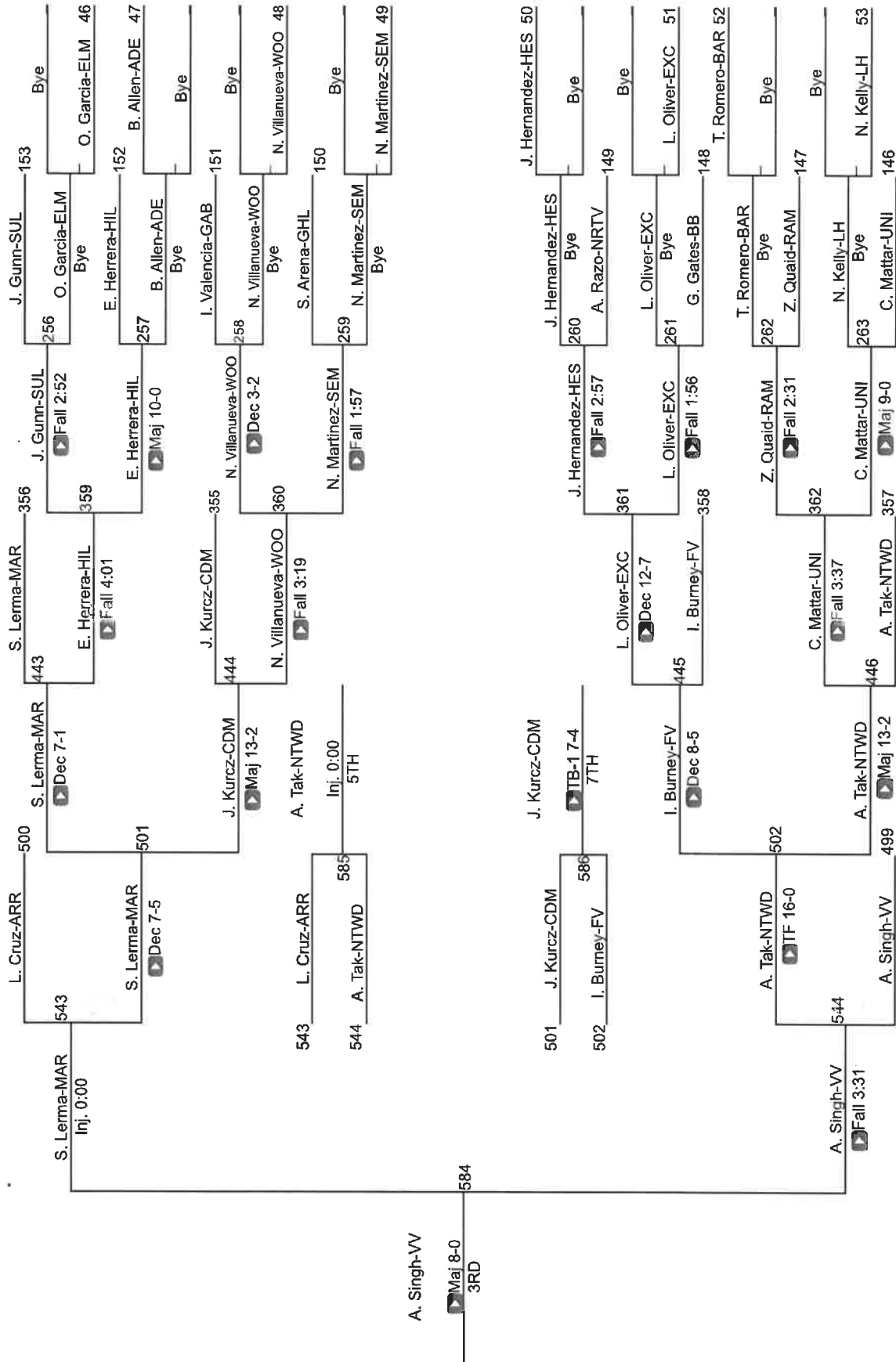

CIF SS Boys Individuals Inland Div

CIF Qualifier 152

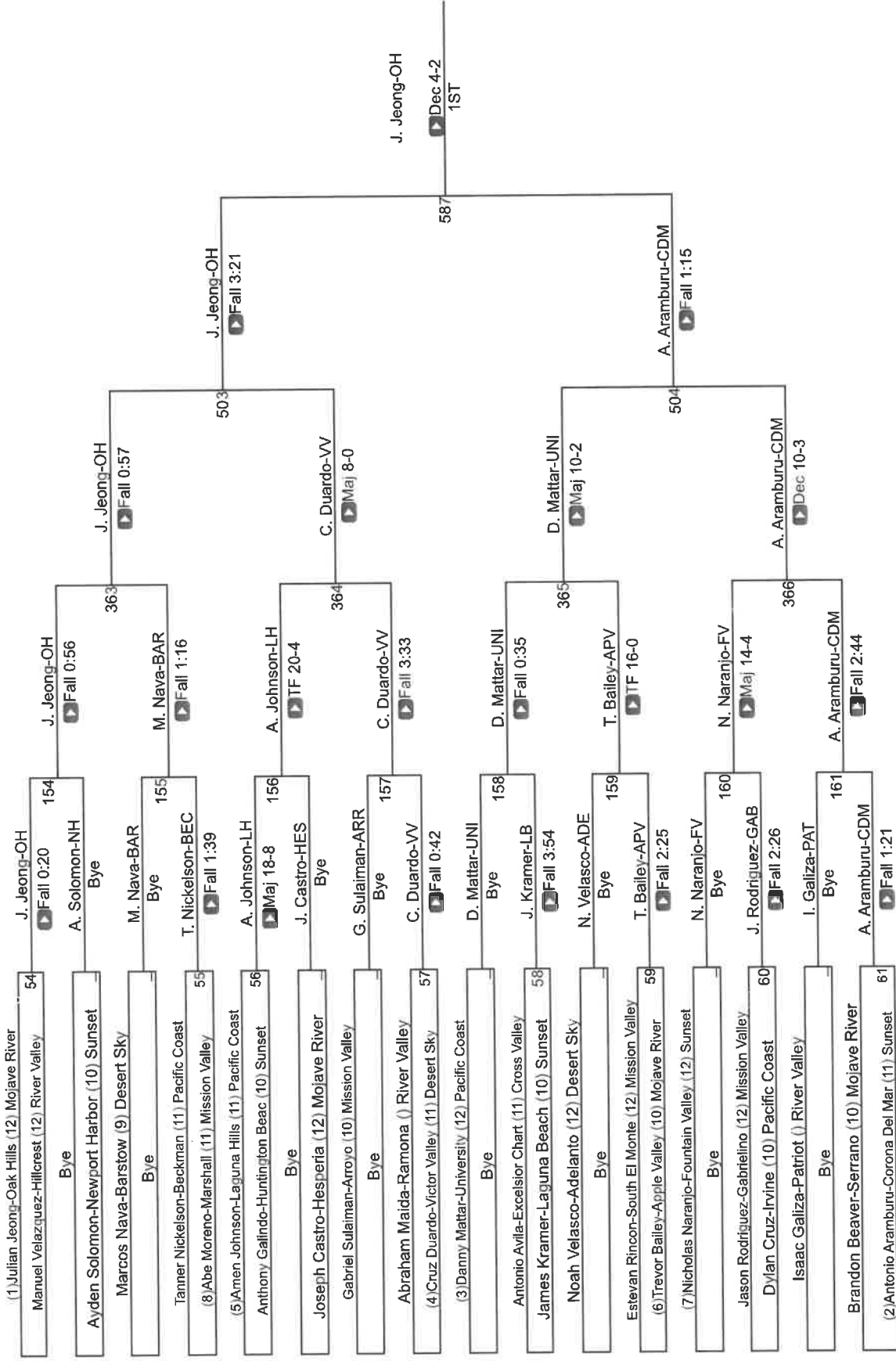

CIF Qualifier 152

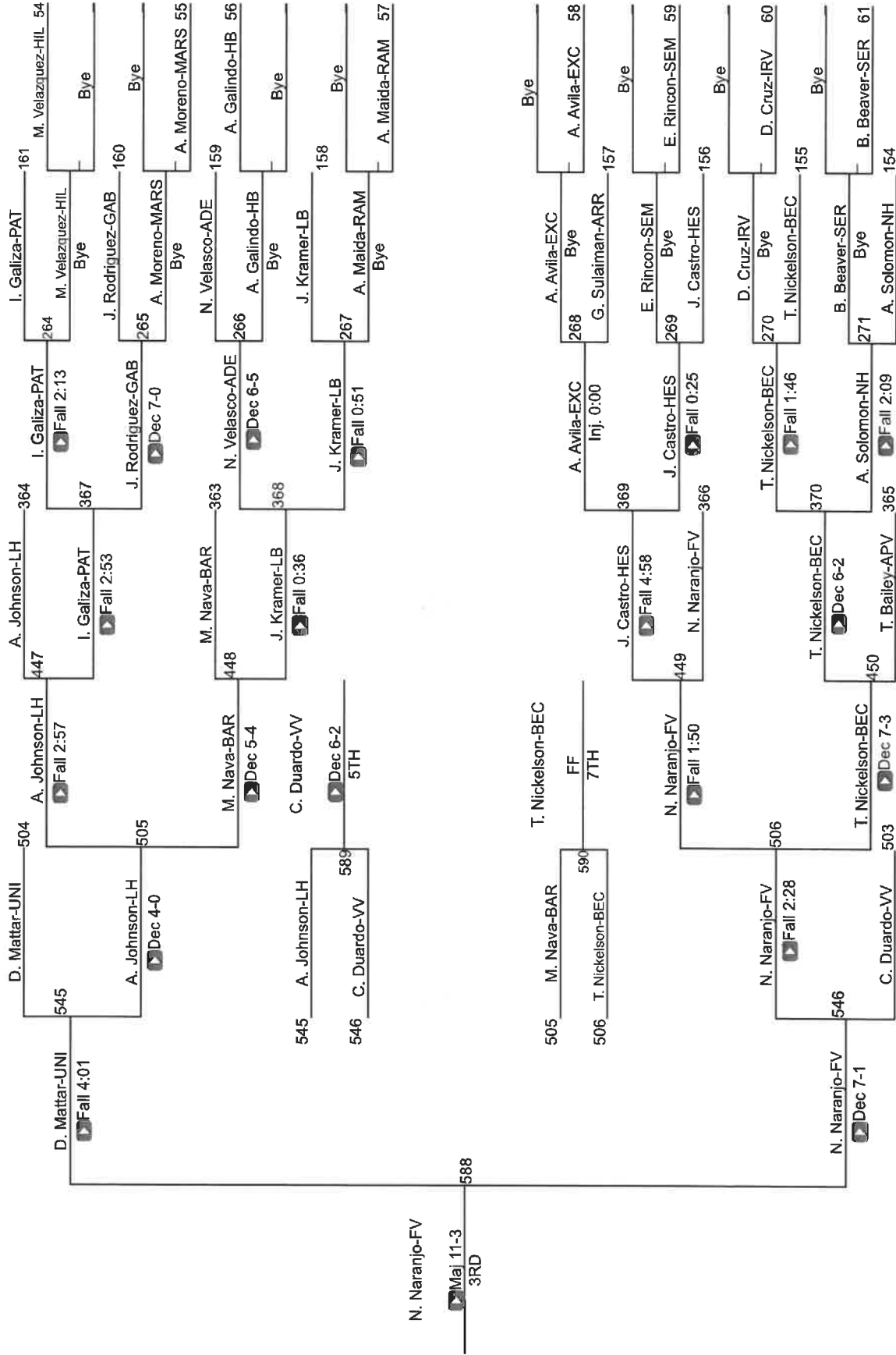

CIF SS Boys Individuals Inland Div

CIF Qualifier 160

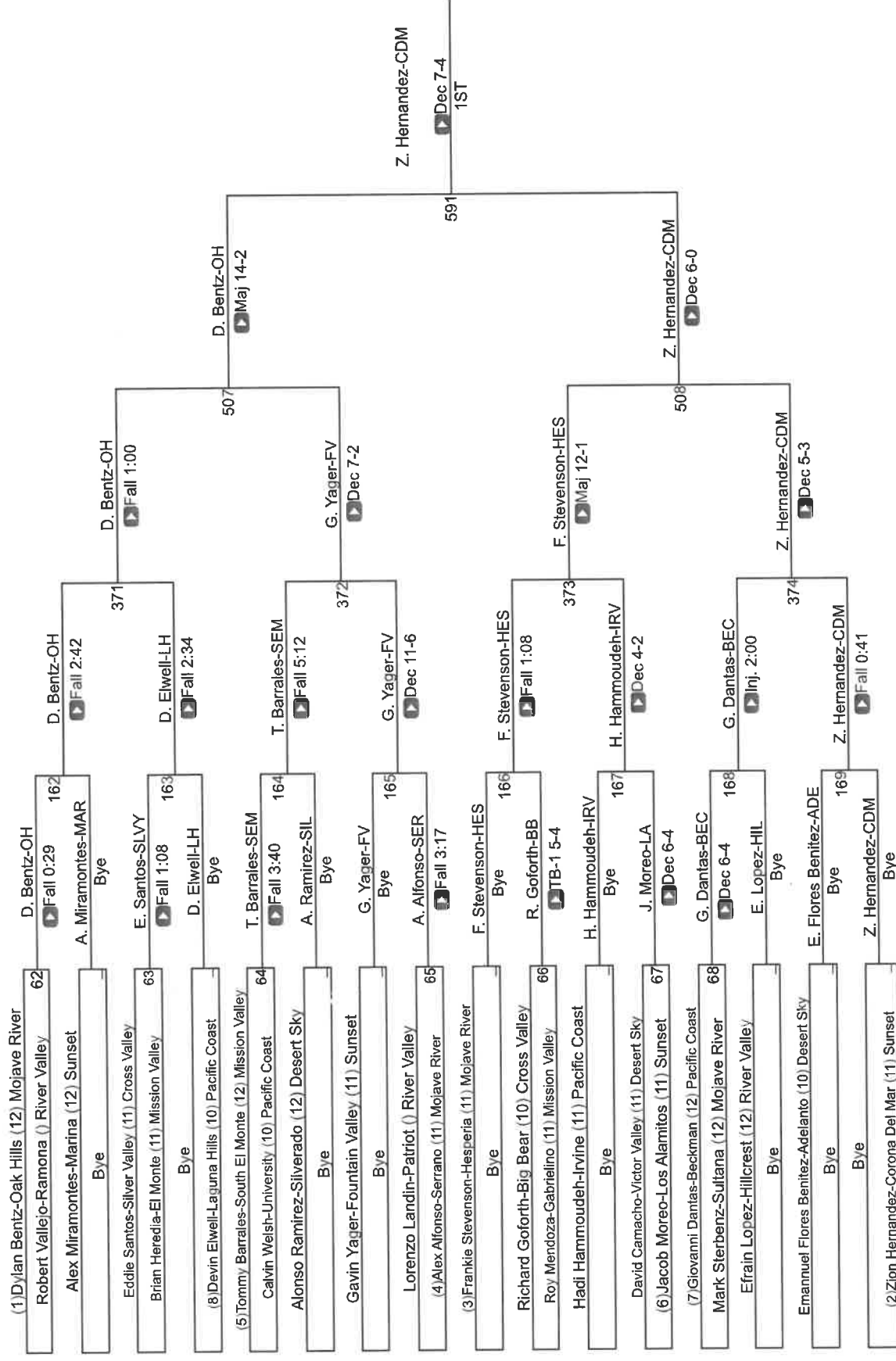

CIF SS Boys Individuals Inland Div

CIF Qualifier 170

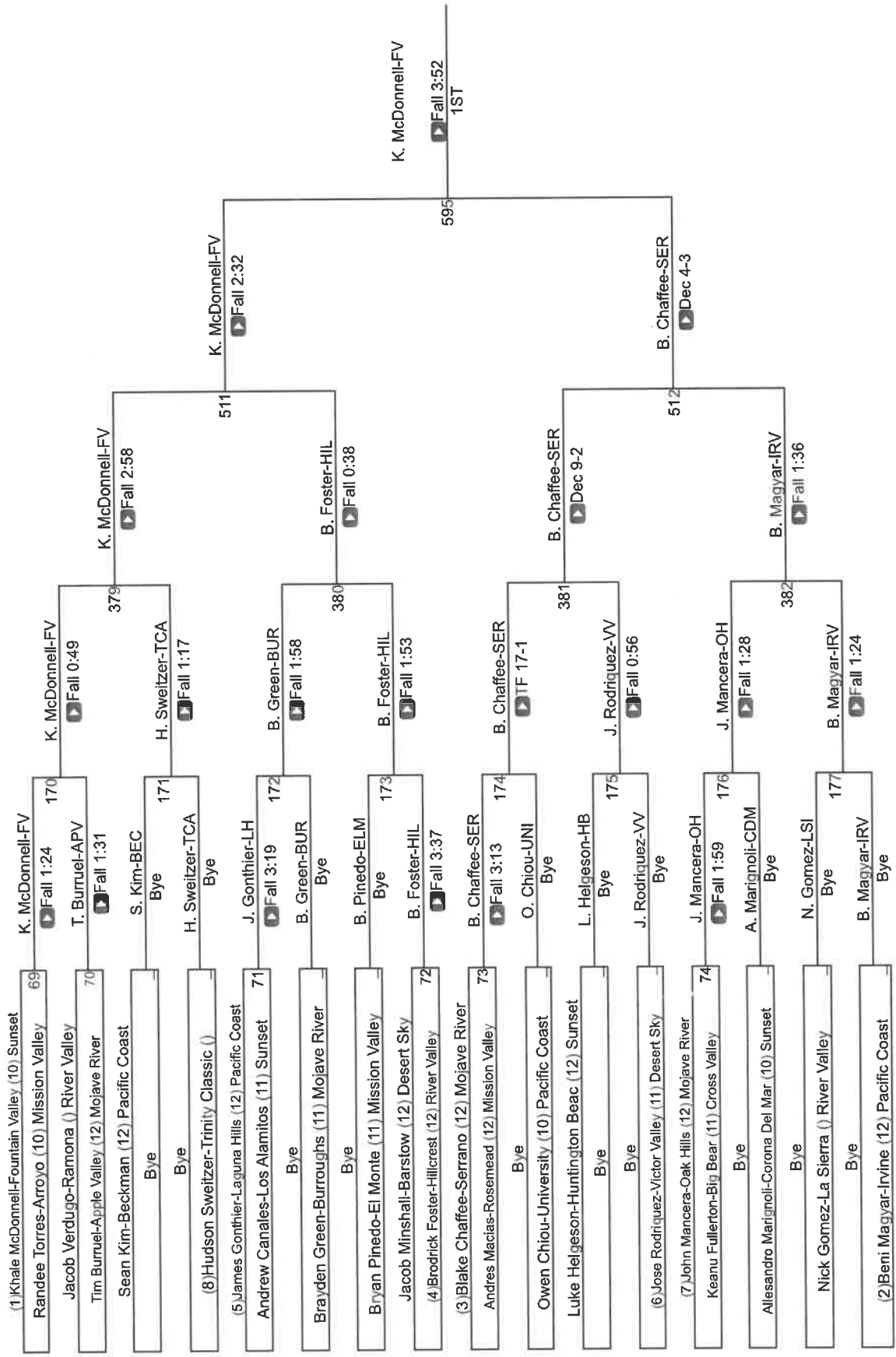

CIF SS Boys Individuals Inland Div

CIF Qualifier 182

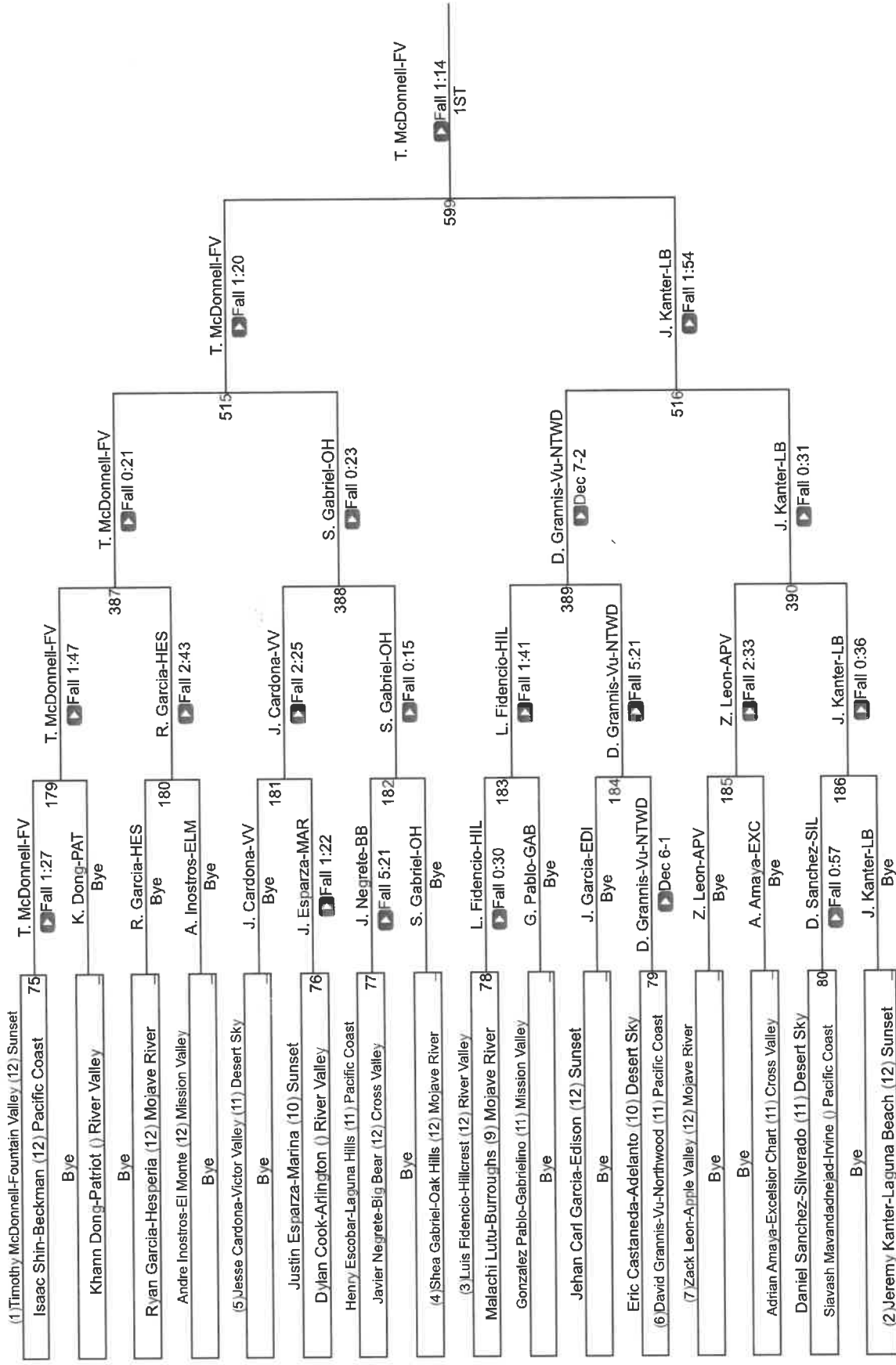

CIF SS Boys Individuals Inland Div

CIF Qualifier 195

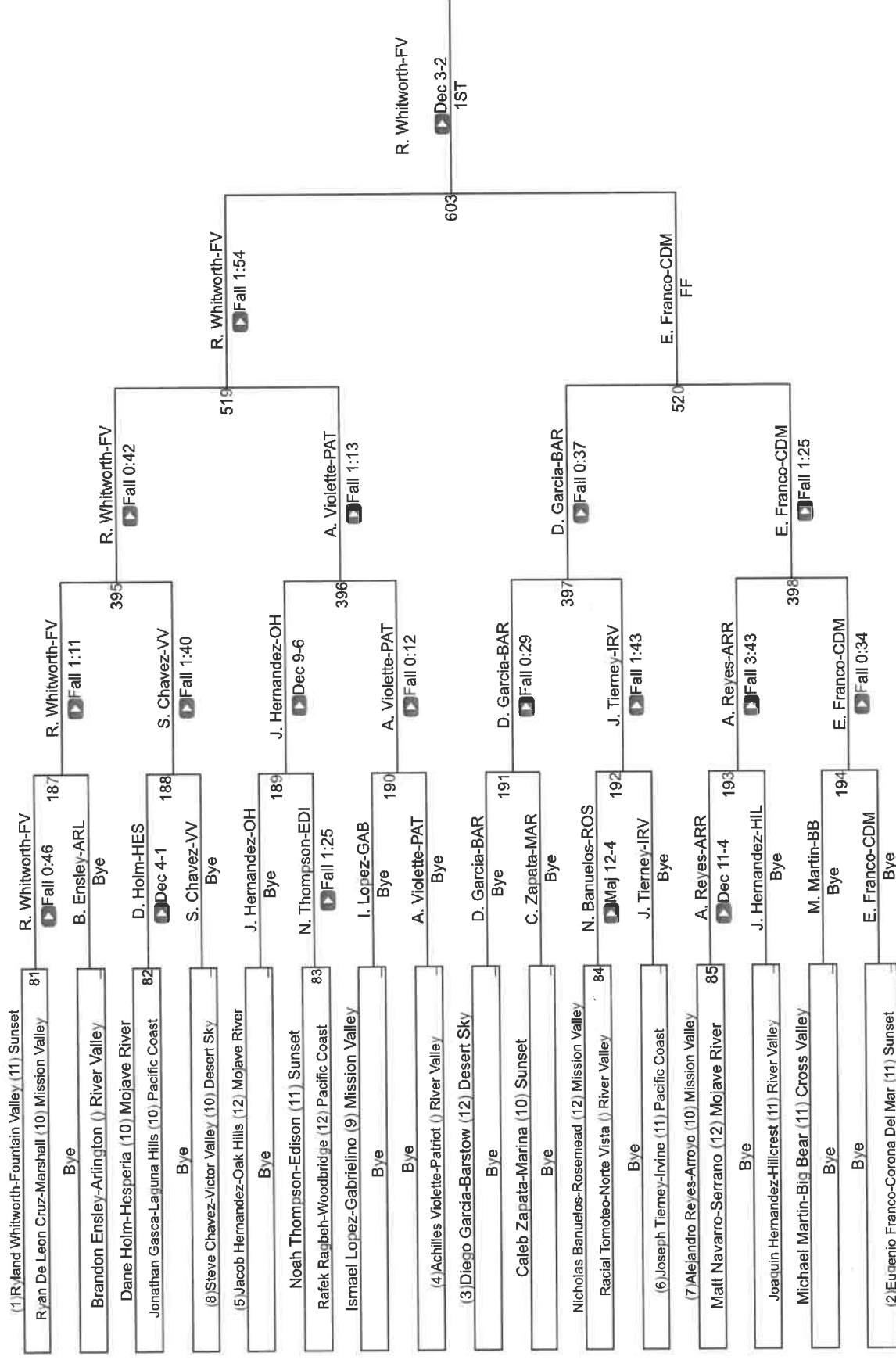

CIF Qualifier 195

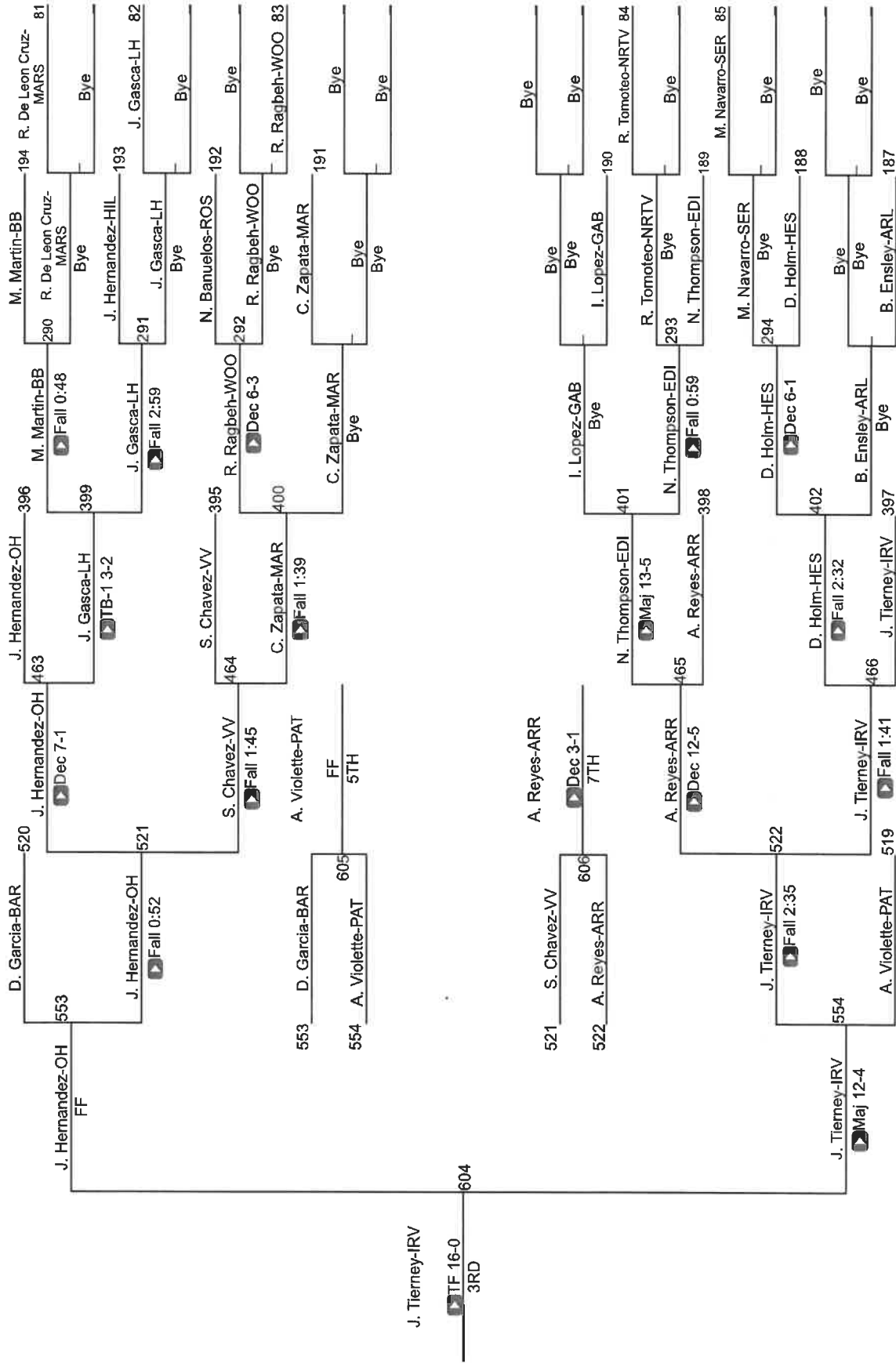

CIF SS Boys Individuals Inland Div

CIF Qualifier 220

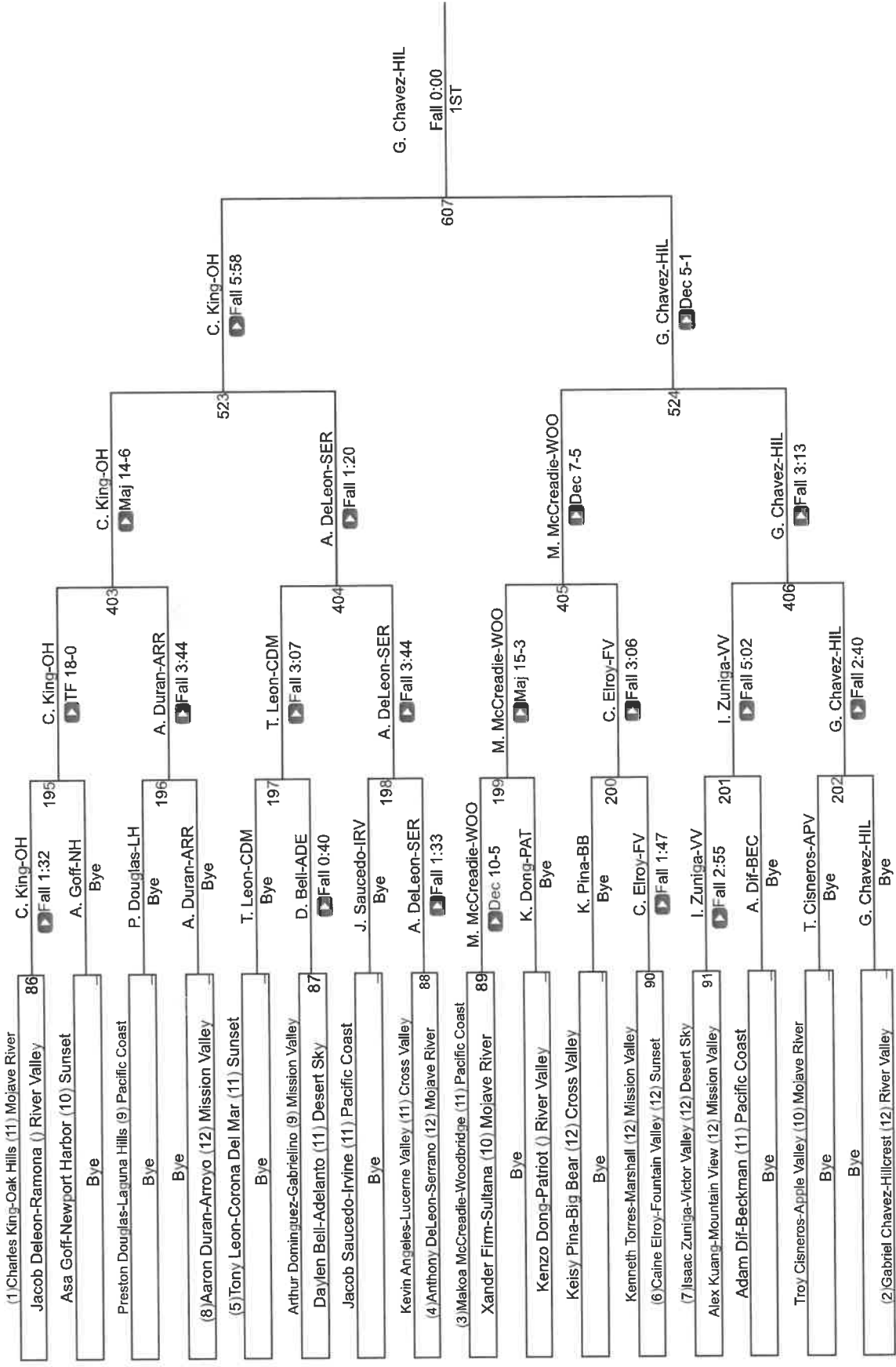

CIF Qualifier 220

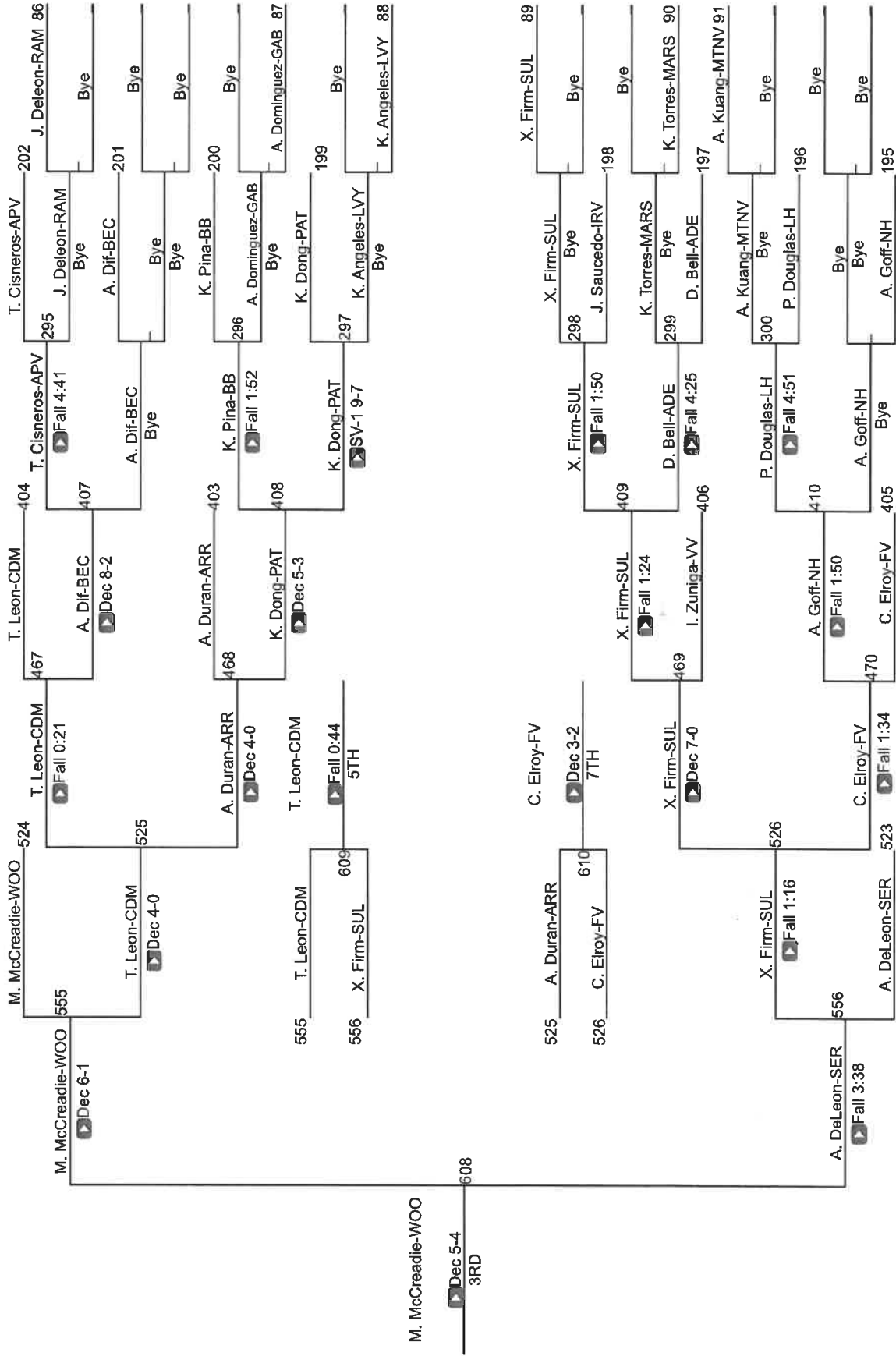

CIF SS Boys Individuals Inland Div

CIF Qualifier 285

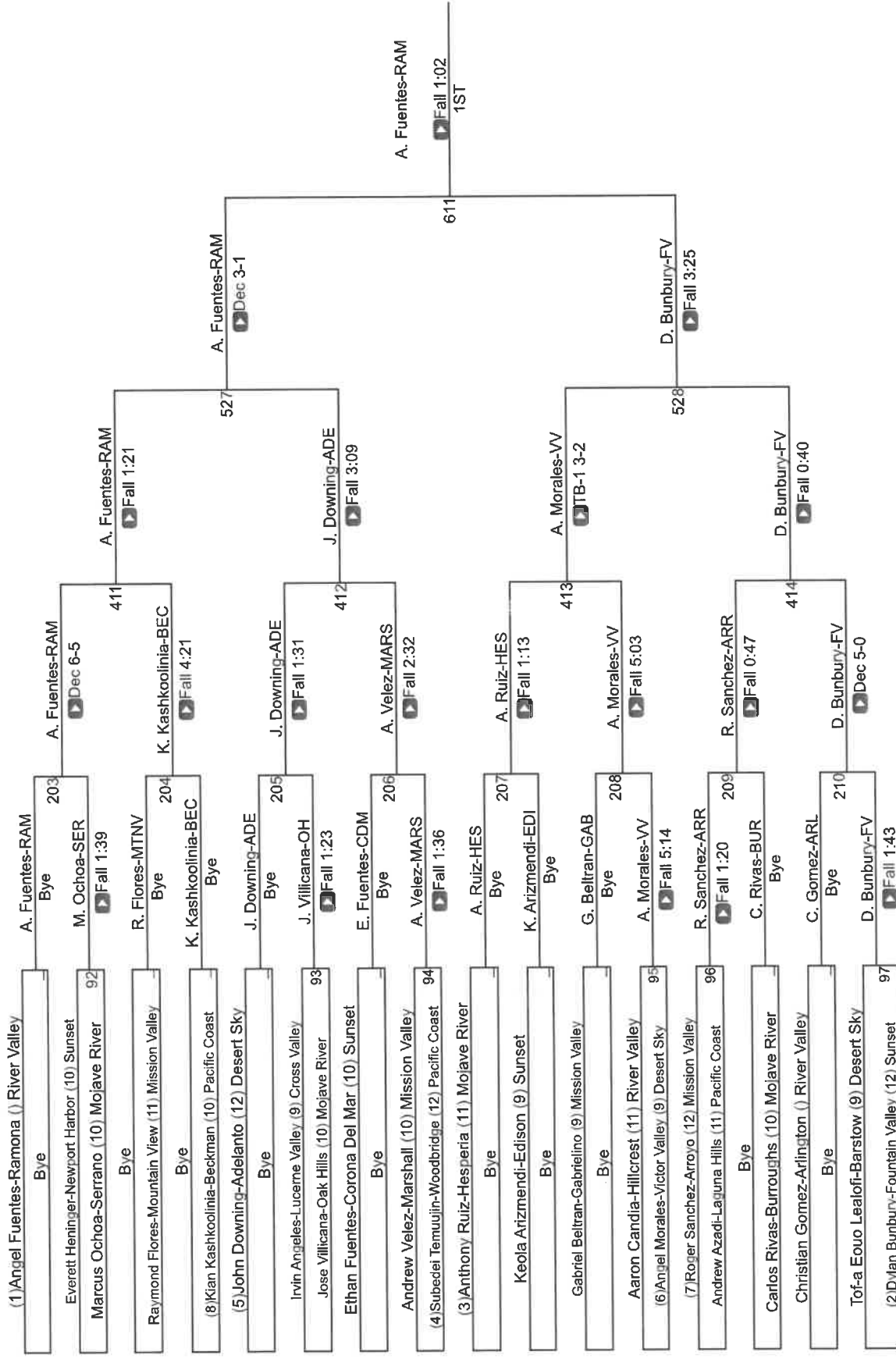

CIF Qualifier 285

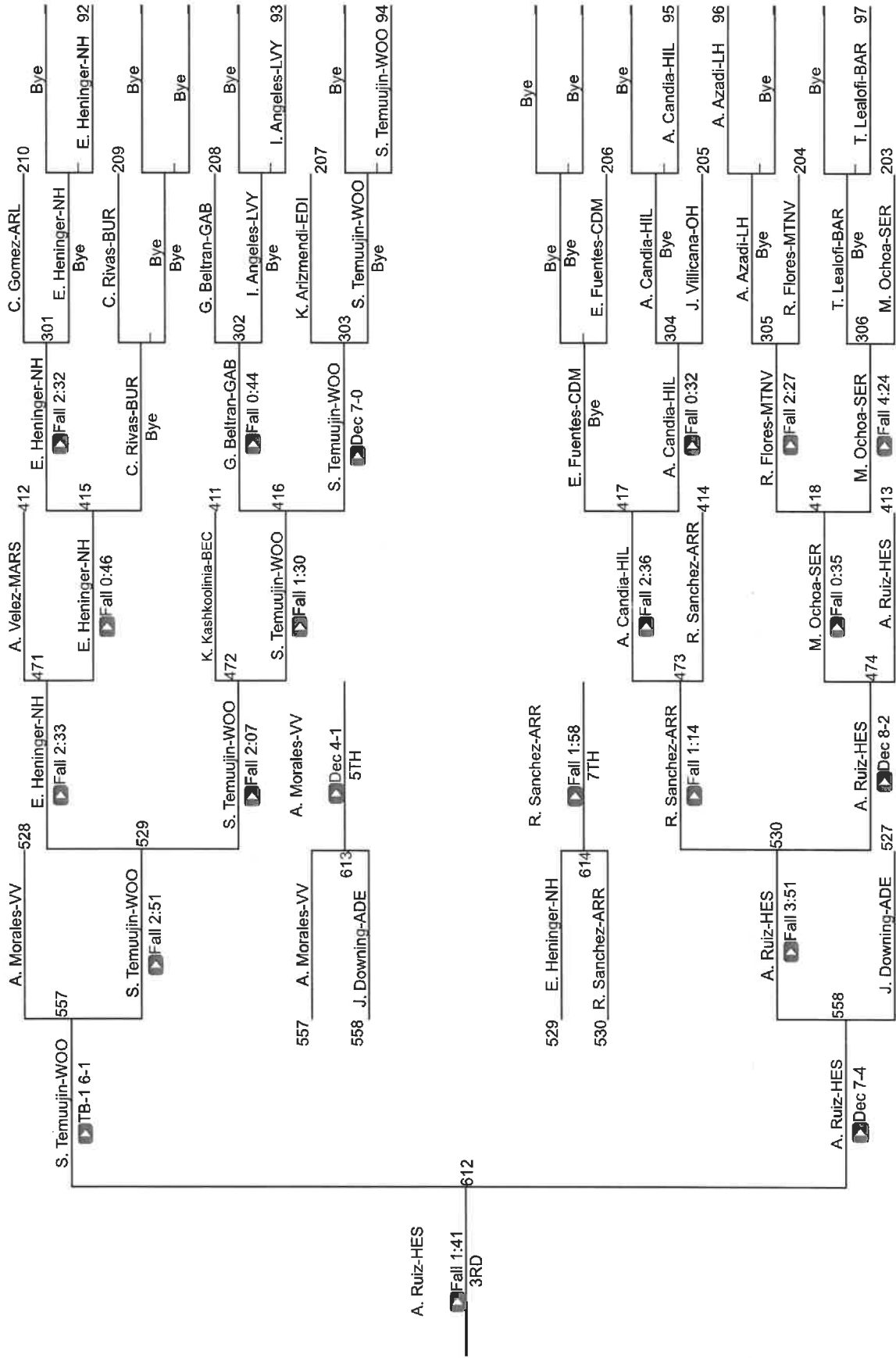

CIF SS Boys Individuals

Northern Division

Brea Olinda High School

February 10-11, 2023



Lower Weight MVP

Isaiah Quinero
El Dorado
120 Pounds

Upper Weight MVP

Kayden Cartee
Mayfair
195 Pounds

Placers

106 Pounds		
1st	Isaiah Cruz	Mayfair
2nd	Julian Santana	Etiwanda
3rd	Sebastian Andrade	Paramount
4th	Alexander Venegas	Eisenhower
5th	Christian Gijon	La Mirada
6th	Joseph Garcia	Magnolia
7th	Daniel Mendoza	Fontana
8th	Rj Gallegos	Los Osos

113 Pounds		
1st	Rob Herrera	Sonora
2nd	Alex Morales	South Torrance
3rd	Jimmy Romero	Cypress
4th	Anthony Mason	La Mirada
5th	Joseph Barnette	Downey
6th	Micah Mailo	Grand Terrace
7th	Ryan Khan	Etiwanda
8th	Emmanuel Hernandez	Fullerton

120 Pounds		
1st	Isaiah Quinero	El Dorado
2nd	Gael Delgado	Warren
3rd	Vince Partington	Cypress
4th	Isaac Gonzalez	Western
5th	Jonathan Sanchez	El Modena
6th	Martin Bocanegra	Rancho Cucamonga
7th	Brandon Walter-Strauss	West Torrance
8th	Luis Romero	Villa Park

126 Pounds		
1st	Jacob Bell	Etiwanda
2nd	Maddox Herrera	Esperanza
3rd	Israel McCrae	Villa Park
4th	Carlos Garcia	Magnolia
5th	Logan Hackman	Los Osos
6th	Esteban Armenta	Mayfair
7th	Santos Reyes	Warren
8th	Nathaniel Dinnyes	Hamilton

132 Pounds		
1st	Gabe Balingit	Etiwanda
2nd	Jake Decker	Canyon
3rd	Bradley Espinoza	Brea Olinda
4th	Ivan Cerpa	Sonora
5th	Jake Jelus	Rancho Cucamonga
6th	Logan Roehl	Yorba Linda
7th	Angelo Andrade	Western
8th	Jimmy Tank Loya	Downey

138 Pounds		
1st	Kenneth Rodgers	Esperanza
2nd	Michael Padilla	Norwalk
3rd	Shawn Torres	La Habra
4th	Elijah Robledo	Mayfair
5th	Jaehawn Lee	South Torrance
6th	Allen Elizondo	Villa Park
7th	Austin McSwain	Etiwanda
8th	Angelo Kim	Brea Olinda

145 Pounds		
1st	Evan Manzo	Etiwanda
2nd	Sean Otero	Norwalk
3rd	Spencer Parry	Yorba Linda
4th	Nathan Marquez	Downey
5th	Joaquin Castro	Eisenhower
6th	Andre Garcia	Savanna
7th	Adam Duong	Upland
8th	Justin Lumbao	West Torrance

152 Pounds		
1st	Tyler Thienngern	Cypress
2nd	Wyatt Wheeler	Yorba Linda
3rd	Joseph Perez	Chino Hills
4th	Frankie Rodriguez	Nuvview Bridge
5th	Alec Sanchez	La Habra
6th	Gavin Tsukiyama	North Torrance
7th	Angel Alcantar	Norwalk
8th	Braiden Nagele	Foothill

160 Pounds		
1st	Will Cox	Yorba Linda
2nd	Andy Perez	Cypress
3rd	Jay Snyder	El Modena
4th	Xingyu Chen	Los Osos
5th	Gerson Arevalo	Lawndale
6th	Jesua Alvarez	Tustin
7th	Angel Orozco	Western
8th	Nathan Acaves	Brea Olinda

170 Pounds		
1st	Roy Haroun	Villa Park
2nd	Farid Sawaya	Valencia Placentia
3rd	Issac Ruiz	Sonora
4th	Diego Ornelas	La Habra
5th	Isaiah Pantoja	Savanna
6th	Joshua Horoutoonian	Yorba Linda
7th	Connar Smith	El Modena
8th	Jacob Carranza	Chino Hills

182 Pounds		
1st	Caleb Smith	Etiwanda
2nd	Ben Setum	Pacifica Garden Grove
3rd	Farzad Hashimi	El Dorado
4th	Michael Whitney	Los Osos
5th	Jacob Longcrier	Troy
6th	James Flores	Western
7th	Aaron Frosrgren	Esperanza
8th	Emilio Casteneda	Fullerton

195 Pounds		
1st	Kayden Cartee	Mayfair
2nd	Ezekiel Ormsby	South Torrance
3rd	Caden Arellano	Damien
4th	Grady Lawson	El Dorado
5th	David Baxter	Sonora
6th	Jessiah Morales	Los Osos
7th	Dj Cobbs	Fullerton
8th	Vincent Navarro	Valencia Placentia

220 Pounds		
1st	Kevin Cardenas	Villa Park
2nd	Nicholas Salabaj	Damien
3rd	Jon Silvestri	Yorba Linda
4th	Troy Hong	Foothill
5th	Ryan Hill	Los Osos
6th	Brandon Saldana	Eisenhower
7th	Caleb Wilson	Nuvview Bridge
8th	Andrea Martinez	El Dorado

285 Pounds		
1st	Dib Sawaya	Valencia Placentia
2nd	Emillano Gonzalez	Sonora
3rd	Matthew Huerta	Warren
4th	Jerry Carlos	Eisenhower
5th	Daniel Torrez	Mayfair
6th	Jayden Alford	North Torrance
7th	Fares Sabe	Cypress
8th	Matson Ochoa	Yorba Linda

Team Score Final	
1	Etiwanda 195.5
2	Cypress 158
3	Yorba Linda 149
4	Mayfair 147.5
5	Villa Park 131
6	Sonora 127.5
7	South Torrance 110.5
8	Warren 101.5
9	Western 97.5
10	Los Osos 97
11	El Dorado 93
12	Esperanza 85.5
13	Eisenhower 83
14	Downey 81
15	Valencia Placentia 81
16	Norwalk 80
17	Damien 78
18	El Modena 73.5
19	La Habra 69.5
20	North Torrance 68
21	Canyon 55.5
22	Nuvview Bridge 55
23	Brea Olinda 52
24	Rancho Cucamonga 52
25	Savanna 51
26	Paramount 50
27	Chino Hills 47.5
28	Fullerton 47
29	La Mirada 45
30	Tustin 43
31	Pacifica Garden Grove 42
32	Santa Rosa Academy 39
33	Foothill 33
34	Magnolia 33
35	West Torrance 31.5
36	Lawndale 31
37	Grand Terrace 30.5
38	Troy 29
39	Upland 25.5
40	Hamilton 24
41	Sunny Hills 20
42	Gahr 19
43	Fontana 18
44	Anaheim 16
45	Notre Dame/Riv 7
46	Santa Ana Valley 7
47	CSDR 6
48	Dominguez 6
49	Rialto 4
50	Aquinas 0
51	Bellflower 0
52	Buena Park 0
53	Kennedy 0
54	Loera 0
55	San Jacinto Valley Academy 0
56	Torrance 0

CIF SS Boys Individuals Northern Div

CIF Qualifier 106

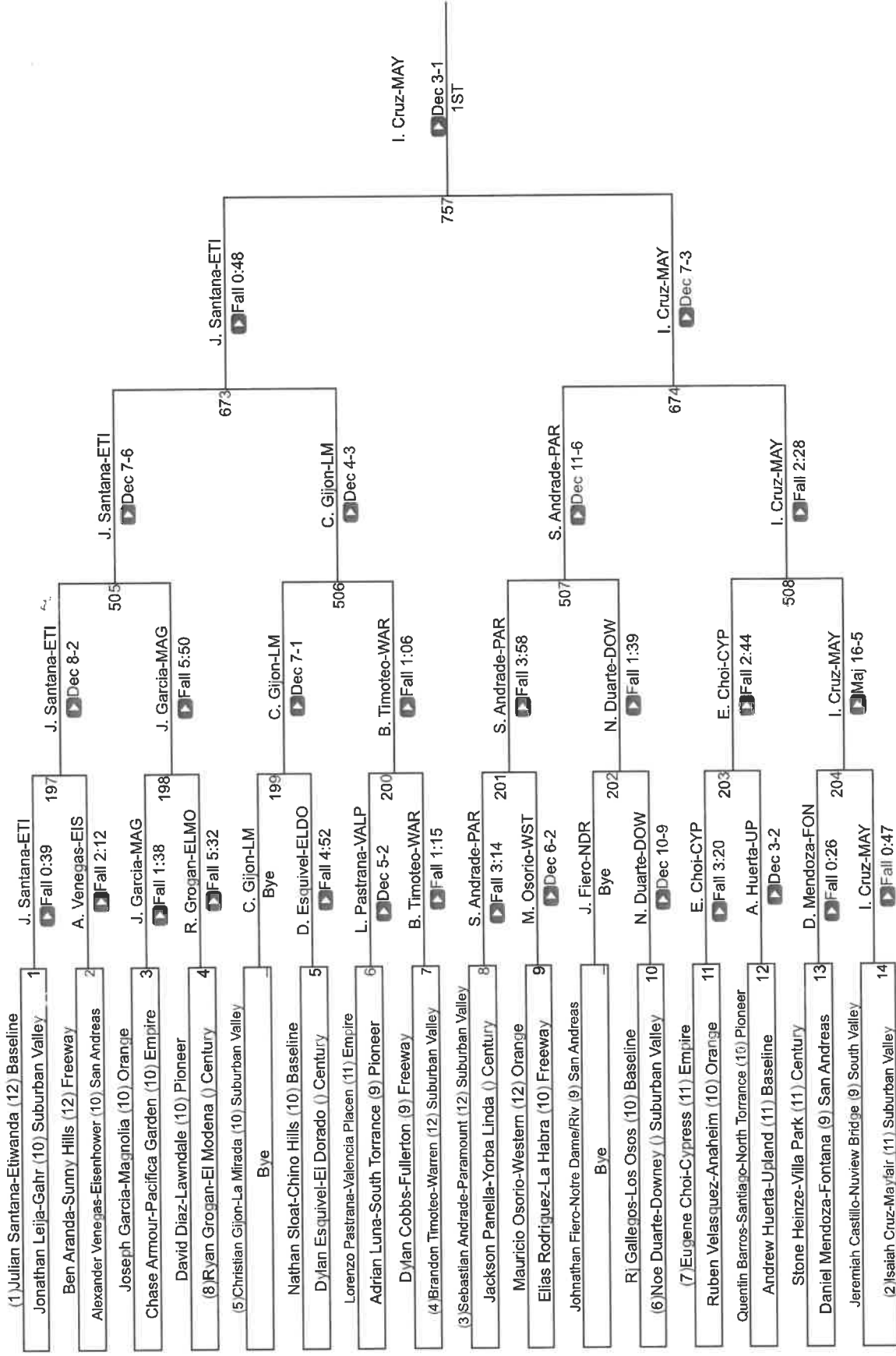

CIF Qualifier 106

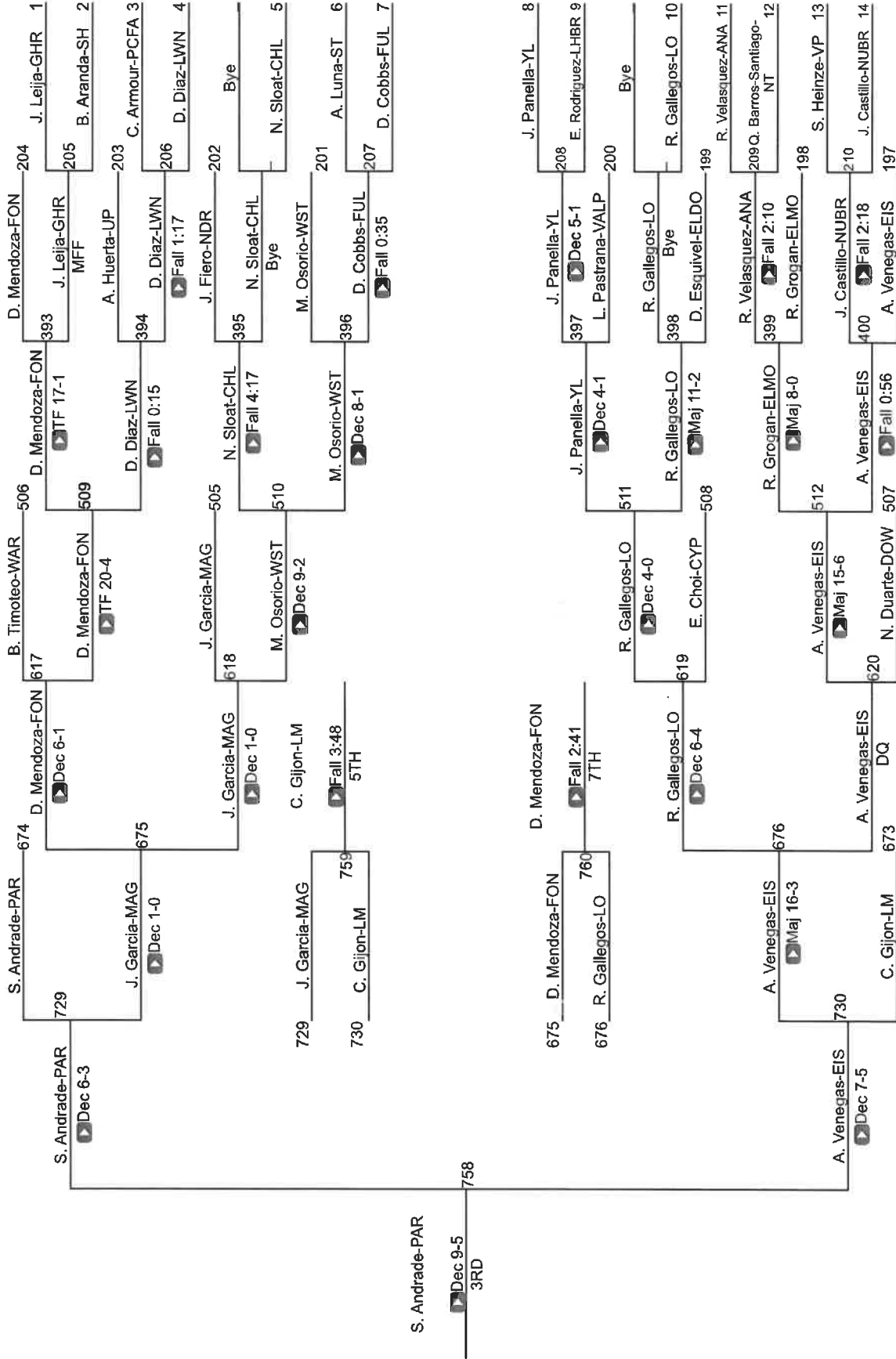

CIF SS Boys Individuals Northern Div

CIF Qualifier 113

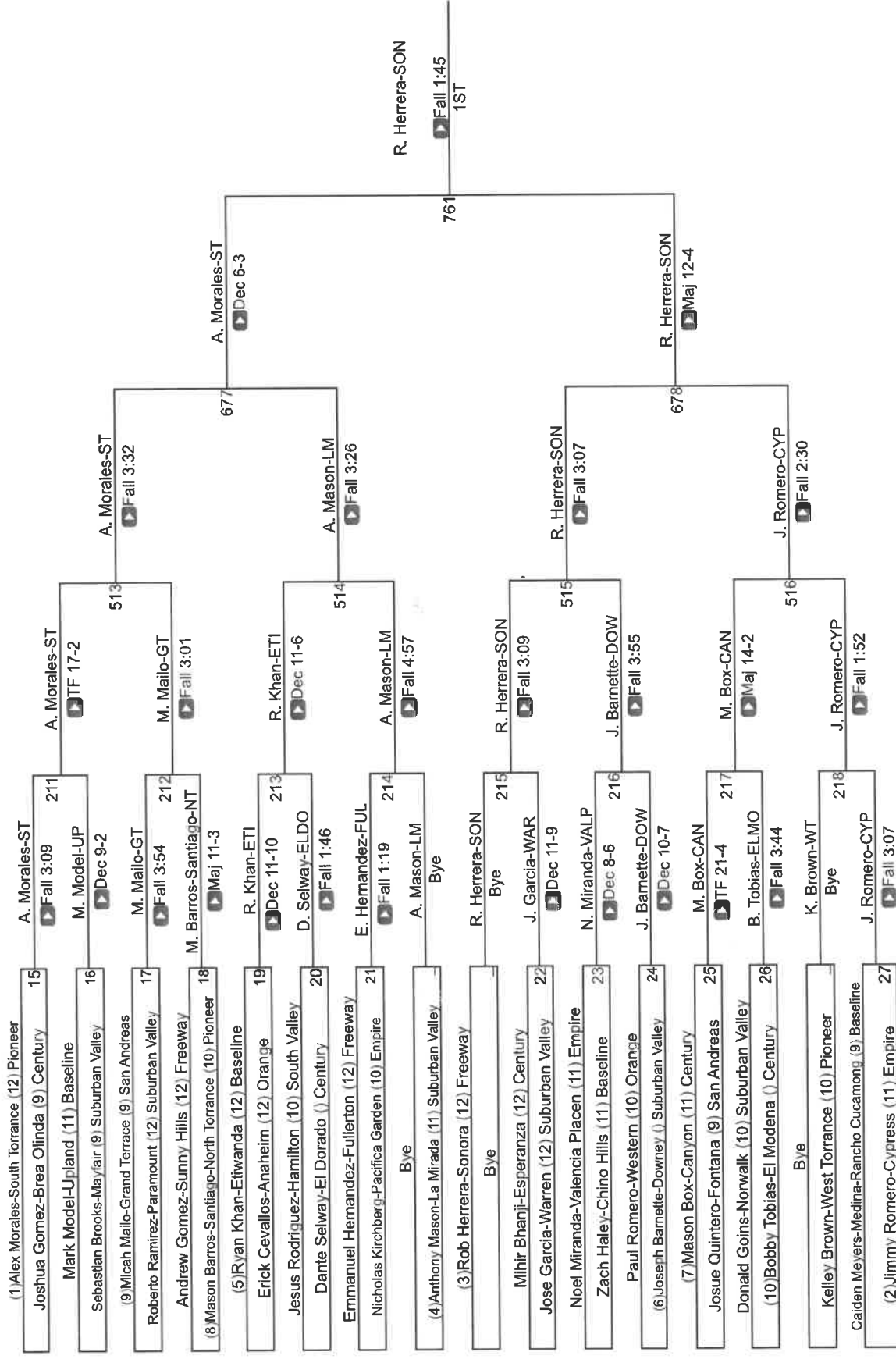

EIF SS Boys Individuals Northern Div

EIF Qualifier 120

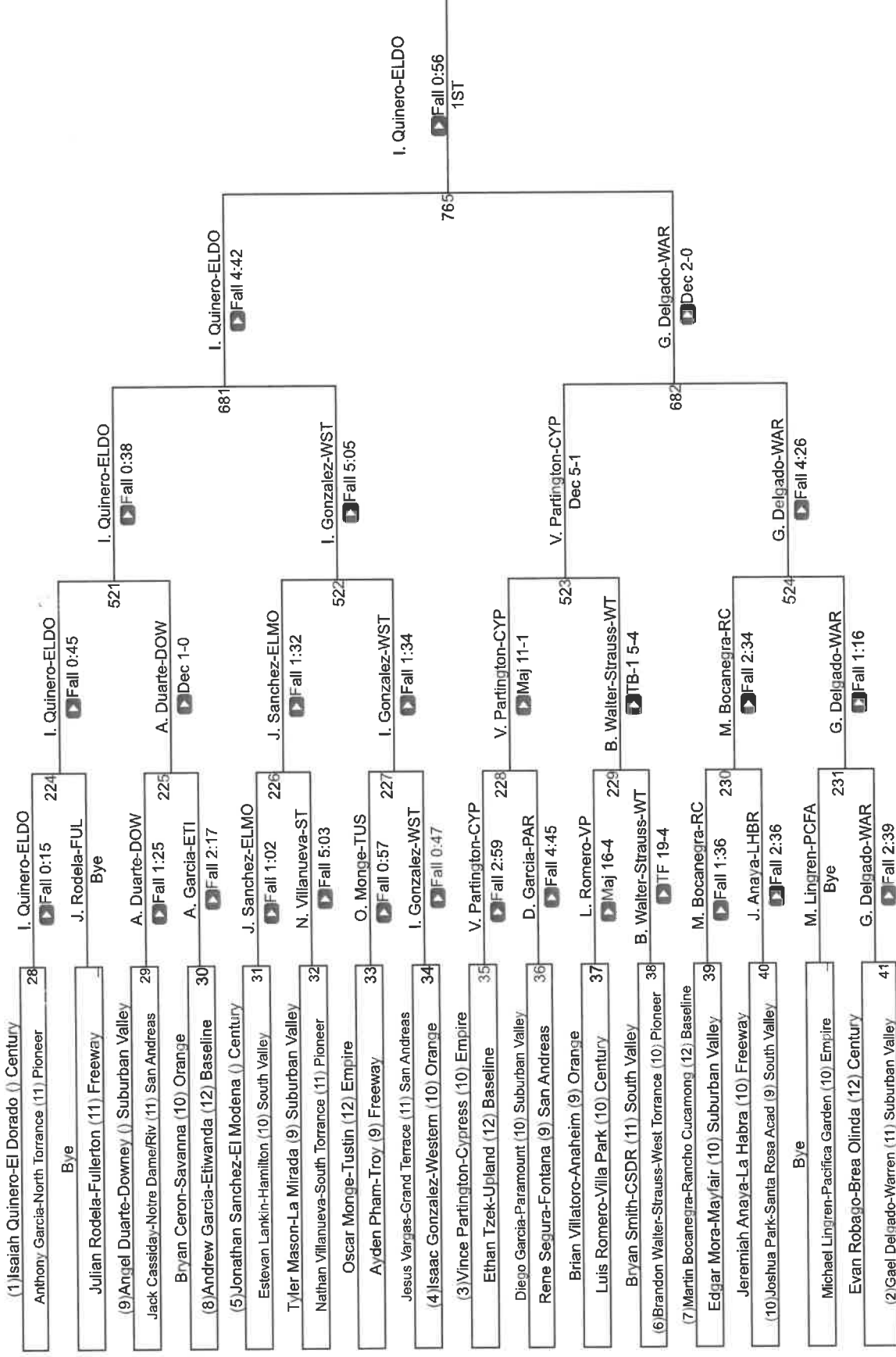

CIF SS Boys Individuals Northern Div

CIF Qualifier 126

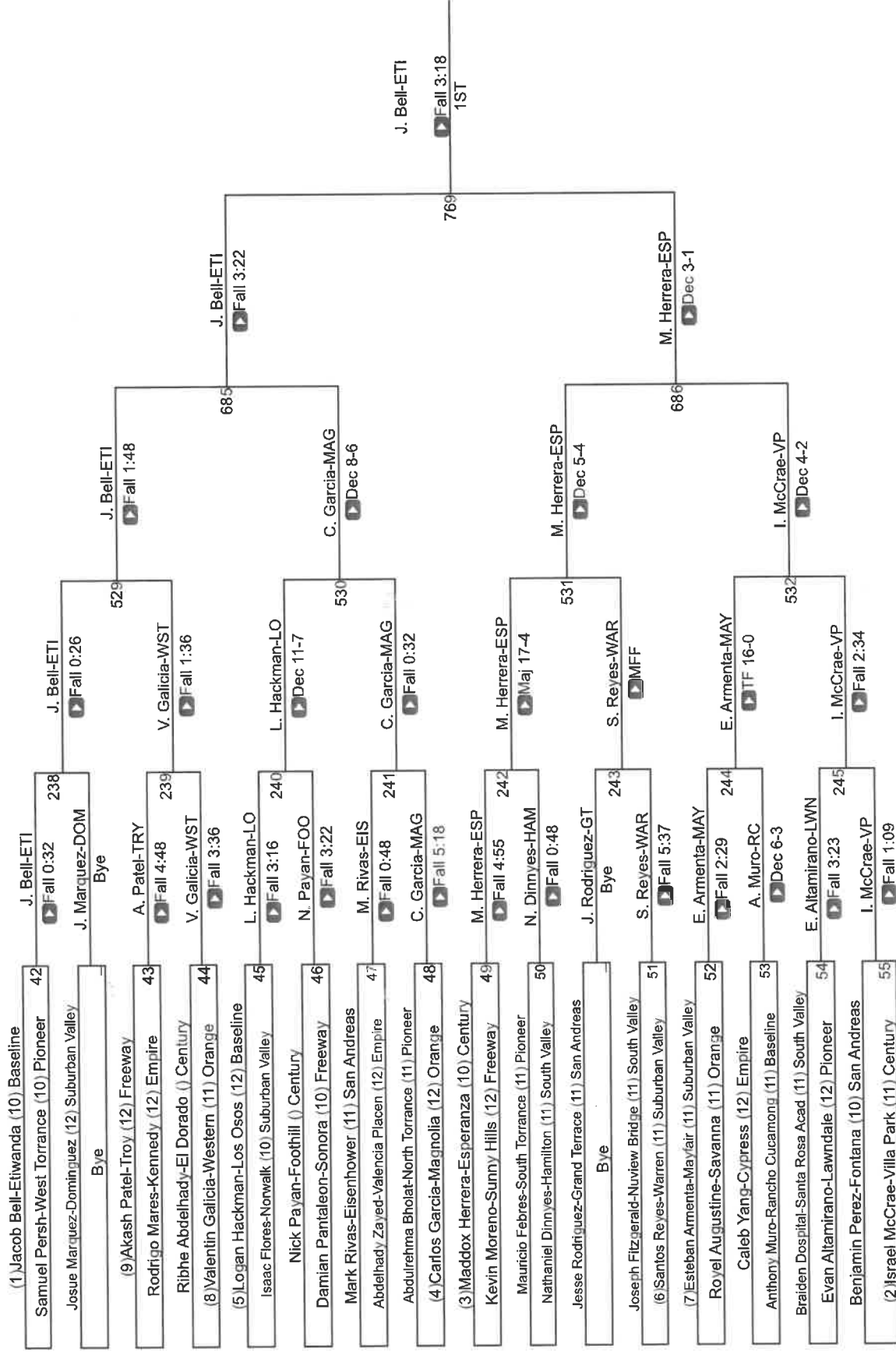

EIF Qualifier 126

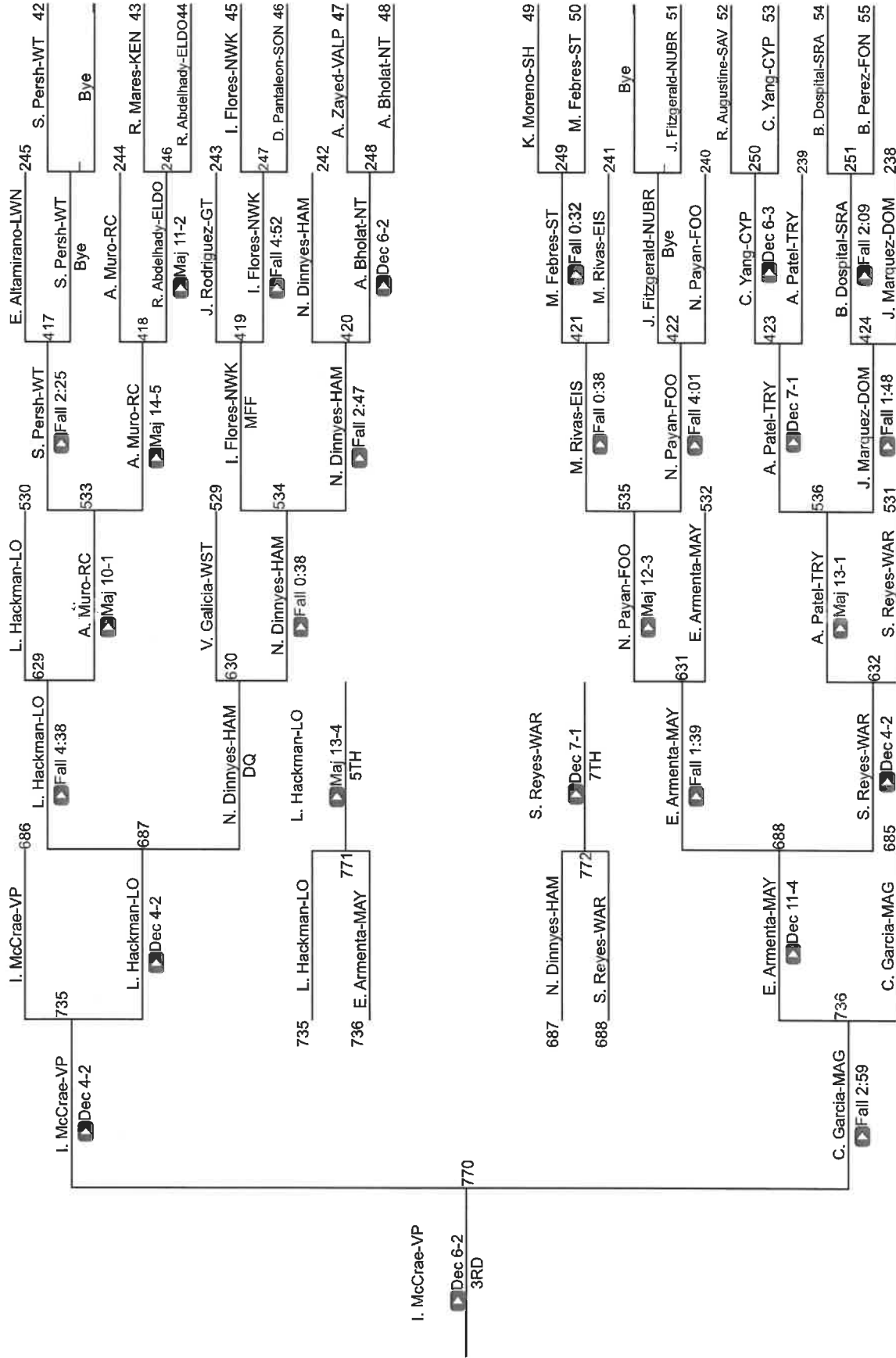

I. McCrae-VP

▶ Dec 6-2
3RD

S. Reyes-WAR

▶ Dec 7-1
7TH

687 N. Dinnyes-HAM

688 S. Reyes-WAR

E. Armenta-MAY

▶ Fall 1:39

E. Armenta-MAY

▶ Dec 11-4

E. Armenta-MAY

▶ Dec 4-2

S. Reyes-WAR

▶ Dec 4-2

C. Garcia-MAG

▶ Fall 2:59

C. Garcia-MAG

▶ Dec 4-2

S. Reyes-WAR

▶ Dec 4-2

C. Garcia-MAG

▶ Dec 4-2

S. Reyes-WAR

▶ Dec 4-2

C. Garcia-MAG

▶ Dec 4-2

S. Reyes-WAR

▶ Dec 4-2

C. Garcia-MAG

▶ Dec 4-2

S. Reyes-WAR

▶ Dec 4-2

C. Garcia-MAG

▶ Dec 4-2

S. Reyes-WAR

▶ Dec 4-2

C. Garcia-MAG

▶ Dec 4-2

S. Reyes-WAR

▶ Dec 4-2

C. Garcia-MAG

▶ Dec 4-2

S. Reyes-WAR

▶ Dec 4-2

C. Garcia-MAG

▶ Dec 4-2

S. Reyes-WAR

▶ Dec 4-2

C. Garcia-MAG

▶ Dec 4-2

S. Reyes-WAR

▶ Dec 4-2

C. Garcia-MAG

▶ Dec 4-2

S. Reyes-WAR

▶ Dec 4-2

C. Garcia-MAG

▶ Dec 4-2

S. Reyes-WAR

▶ Dec 4-2

C. Garcia-MAG

▶ Dec 4-2

S. Reyes-WAR

▶ Dec 4-2

C. Garcia-MAG

▶ Dec 4-2

S. Reyes-WAR

▶ Dec 4-2

C. Garcia-MAG

▶ Dec 4-2

S. Reyes-WAR

▶ Dec 4-2

C. Garcia-MAG

▶ Dec 4-2

S. Reyes-WAR

▶ Dec 4-2

C. Garcia-MAG

▶ Dec 4-2

S. Reyes-WAR

▶ Dec 4-2

C. Garcia-MAG

▶ Dec 4-2

S. Reyes-WAR

▶ Dec 4-2

C. Garcia-MAG

▶ Dec 4-2

S. Reyes-WAR

▶ Dec 4-2

C. Garcia-MAG

▶ Dec 4-2

S. Reyes-WAR

▶ Dec 4-2

C. Garcia-MAG

▶ Dec 4-2

S. Reyes-WAR

▶ Dec 4-2

C. Garcia-MAG

▶ Dec 4-2

S. Reyes-WAR

▶ Dec 4-2

C. Garcia-MAG

▶ Dec 4-2

S. Reyes-WAR

▶ Dec 4-2

C. Garcia-MAG

▶ Dec 4-2

S. Reyes-WAR

▶ Dec 4-2

C. Garcia-MAG

▶ Dec 4-2

S. Reyes-WAR

▶ Dec 4-2

C. Garcia-MAG

▶ Dec 4-2

S. Reyes-WAR

▶ Dec 4-2

C. Garcia-MAG

▶ Dec 4-2

S. Reyes-WAR

▶ Dec 4-2

C. Garcia-MAG

▶ Dec 4-2

S. Reyes-WAR

▶ Dec 4-2

C. Garcia-MAG

▶ Dec 4-2

S. Reyes-WAR

▶ Dec 4-2

C. Garcia-MAG

▶ Dec 4-2

S. Reyes-WAR

▶ Dec 4-2

C. Garcia-MAG

▶ Dec 4-2

S. Reyes-WAR

▶ Dec 4-2

C. Garcia-MAG

▶ Dec 4-2

S. Reyes-WAR

▶ Dec 4-2

C. Garcia-MAG

▶ Dec 4-2

S. Reyes-WAR

▶ Dec 4-2

C. Garcia-MAG

▶ Dec 4-2

S. Reyes-WAR

▶ Dec 4-2

C. Garcia-MAG

▶ Dec 4-2

S. Reyes-WAR

▶ Dec 4-2

C. Garcia-MAG

▶ Dec 4-2

S. Reyes-WAR

▶ Dec 4-2

C. Garcia-MAG

▶ Dec 4-2

S. Reyes-WAR

▶ Dec 4-2

C. Garcia-MAG

▶ Dec 4-2

S. Reyes-WAR

▶ Dec 4-2

C. Garcia-MAG

▶ Dec 4-2

S. Reyes-WAR

▶ Dec 4-2

C. Garcia-MAG

▶ Dec 4-2

S. Reyes-WAR

▶ Dec 4-2

C. Garcia-MAG

▶ Dec 4-2

S. Reyes-WAR

▶ Dec 4-2

C. Garcia-MAG

▶ Dec 4-2

S. Reyes-WAR

▶ Dec 4-2

C. Garcia-MAG

▶ Dec 4-2

S. Reyes-WAR

▶ Dec 4-2

C. Garcia-MAG

▶ Dec 4-2

S. Reyes-WAR

▶ Dec 4-2

C. Garcia-MAG

▶ Dec 4-2

S. Reyes-WAR

▶ Dec 4-2

C. Garcia-MAG

▶ Dec 4-2

S. Reyes-WAR

▶ Dec 4-2

C. Garcia-MAG

▶ Dec 4-2

S. Reyes-WAR

▶ Dec 4-2

C. Garcia-MAG

▶ Dec 4-2

S. Reyes-WAR

▶ Dec 4-2

C. Garcia-MAG

▶ Dec 4-2

S. Reyes-WAR

▶ Dec 4-2

C. Garcia-MAG

▶ Dec 4-2

S. Reyes-WAR

▶ Dec 4-2

C. Garcia-MAG

▶ Dec 4-2

S. Reyes-WAR

▶ Dec 4-2

C. Garcia-MAG

▶ Dec 4-2

S. Reyes-WAR

▶ Dec 4-2

C. Garcia-MAG

▶ Dec 4-2

S. Reyes-WAR

▶ Dec 4-2

C. Garcia-MAG

▶ Dec 4-2

S. Reyes-WAR

▶ Dec 4-2

C. Garcia-MAG

▶ Dec 4-2

S. Reyes-WAR

▶ Dec 4-2

C. Garcia-MAG

▶ Dec 4-2

S. Reyes-WAR

▶ Dec 4-2

C. Garcia-MAG

▶ Dec 4-2

S. Reyes-WAR

▶ Dec 4-2

C. Garcia-MAG

▶ Dec 4-2

S. Reyes-WAR

▶ Dec 4-2

C. Garcia-MAG

▶ Dec 4-2

S. Reyes-WAR

▶ Dec 4-2

C. Garcia-MAG

▶ Dec 4-2

S. Reyes-WAR

▶ Dec 4-2

C. Garcia-MAG

▶ Dec 4-2

S. Reyes-WAR

▶ Dec 4-2

C. Garcia-MAG

▶ Dec 4-2

S. Reyes-WAR

▶ Dec 4-2

C. Garcia-MAG

▶ Dec 4-2

S. Reyes-WAR

▶ Dec 4-2

C. Garcia-MAG

▶ Dec 4-2

S. Reyes-WAR

▶ Dec 4-2

CIF SS Boys Individuals Northern Div

CIF Qualifier 132

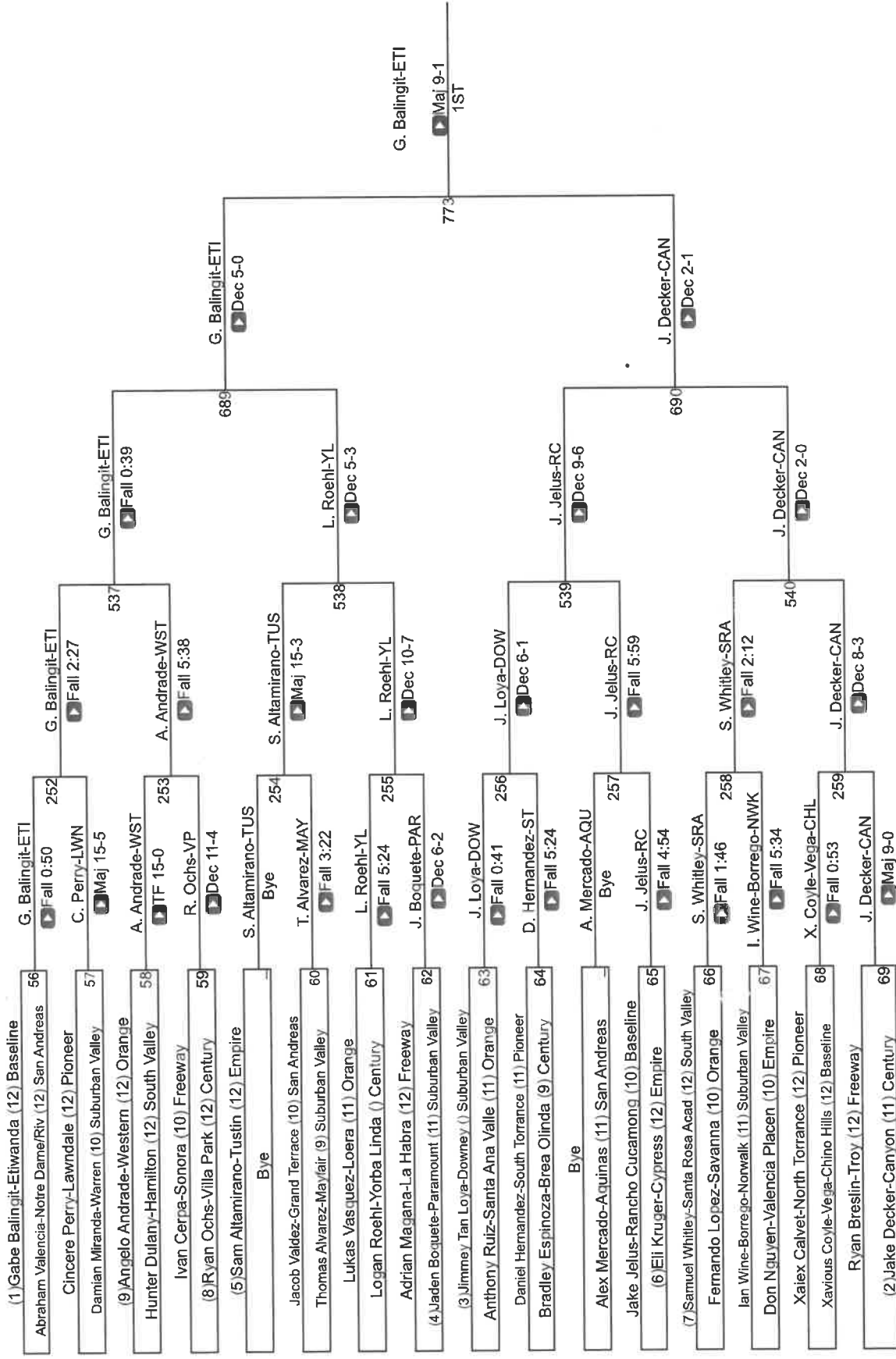

CIF Qualifier 132

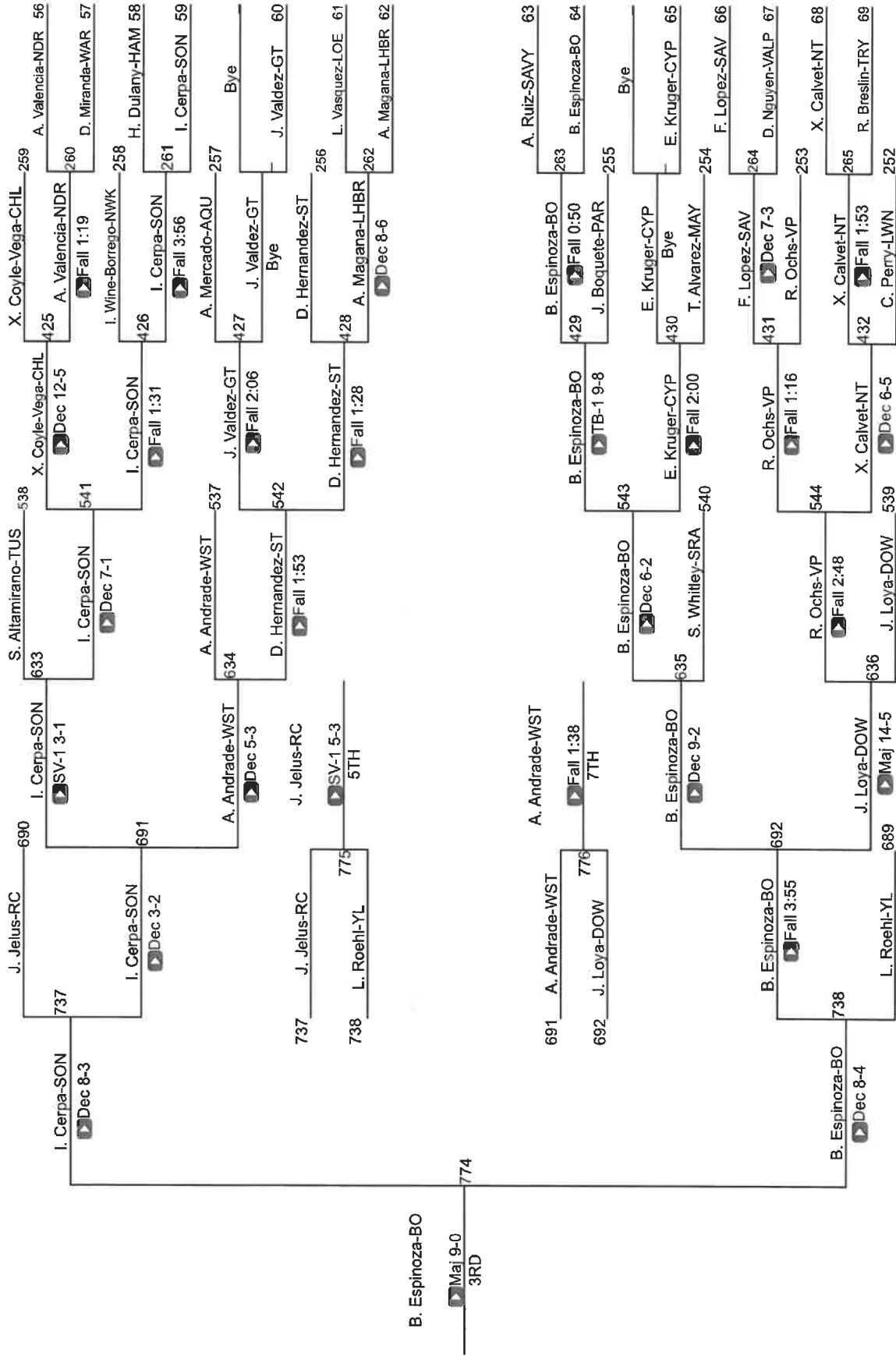

CIF SS Boys Individuals Northern Div

CIF Qualifier 145

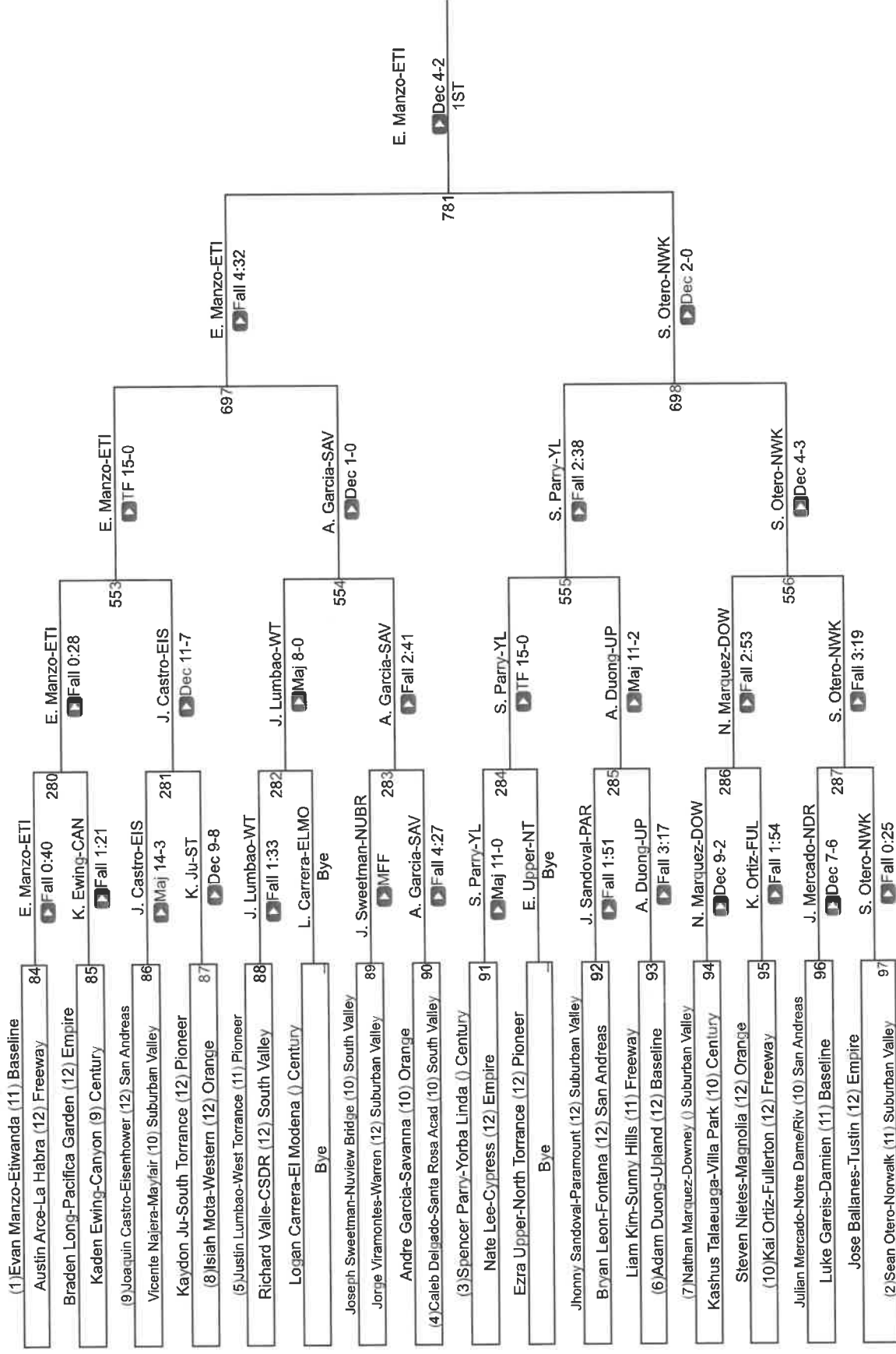

CIF SS Boys Individuals Northern Div

CIF Qualifier 152

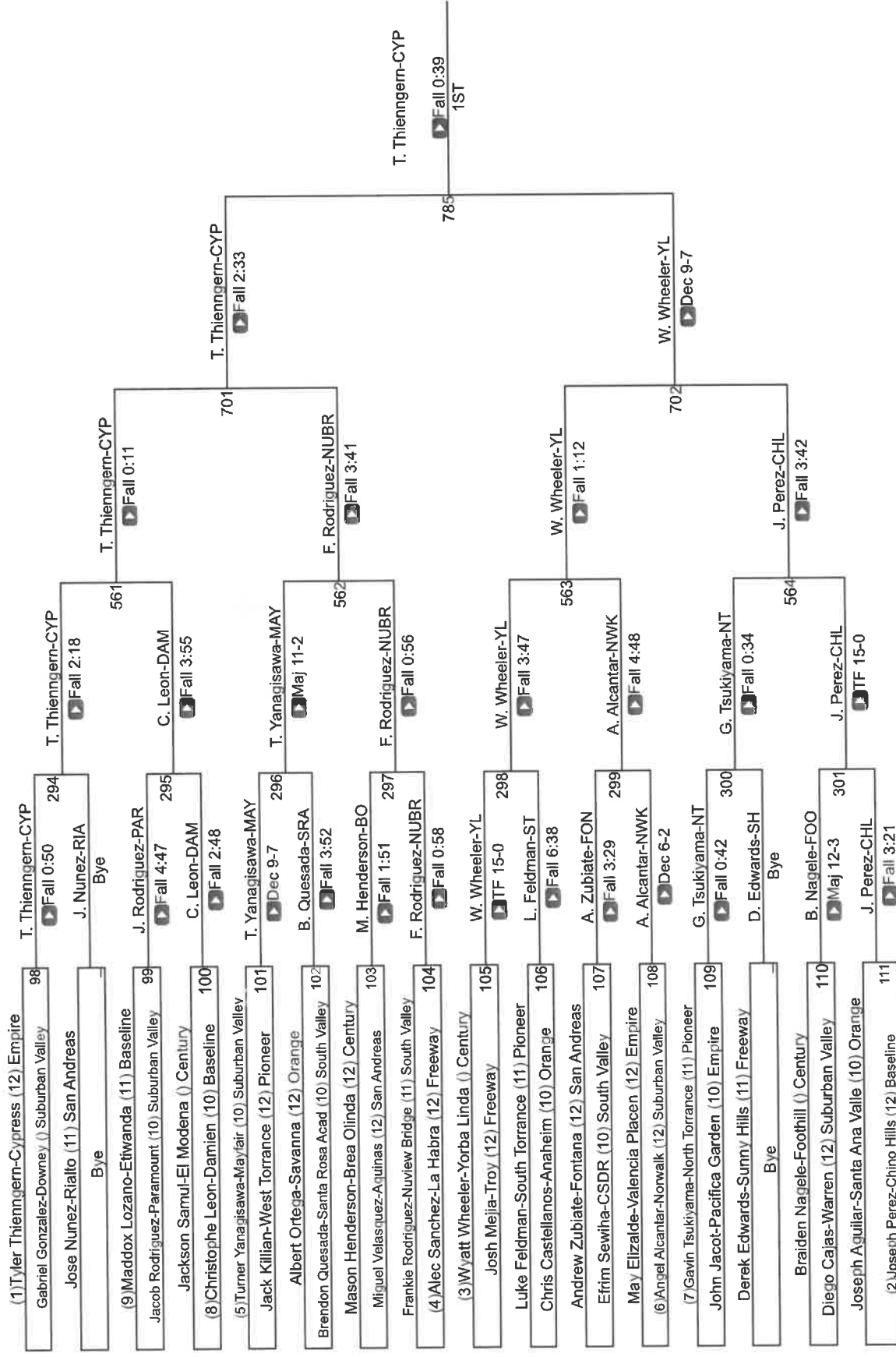

CIF SS Boys Individuals Northern Div

CIF Qualifier 160

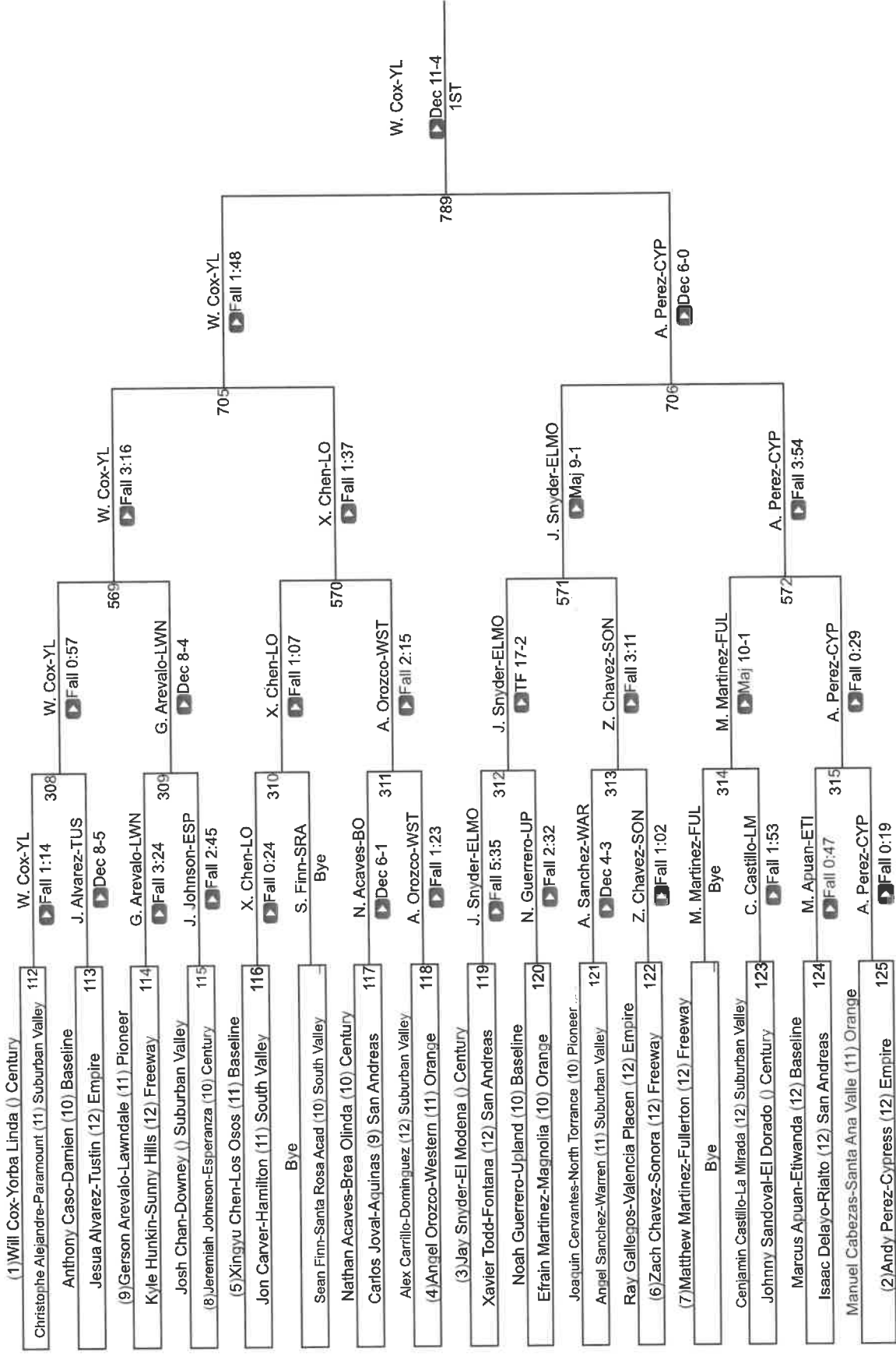

CIF Qualifier 160

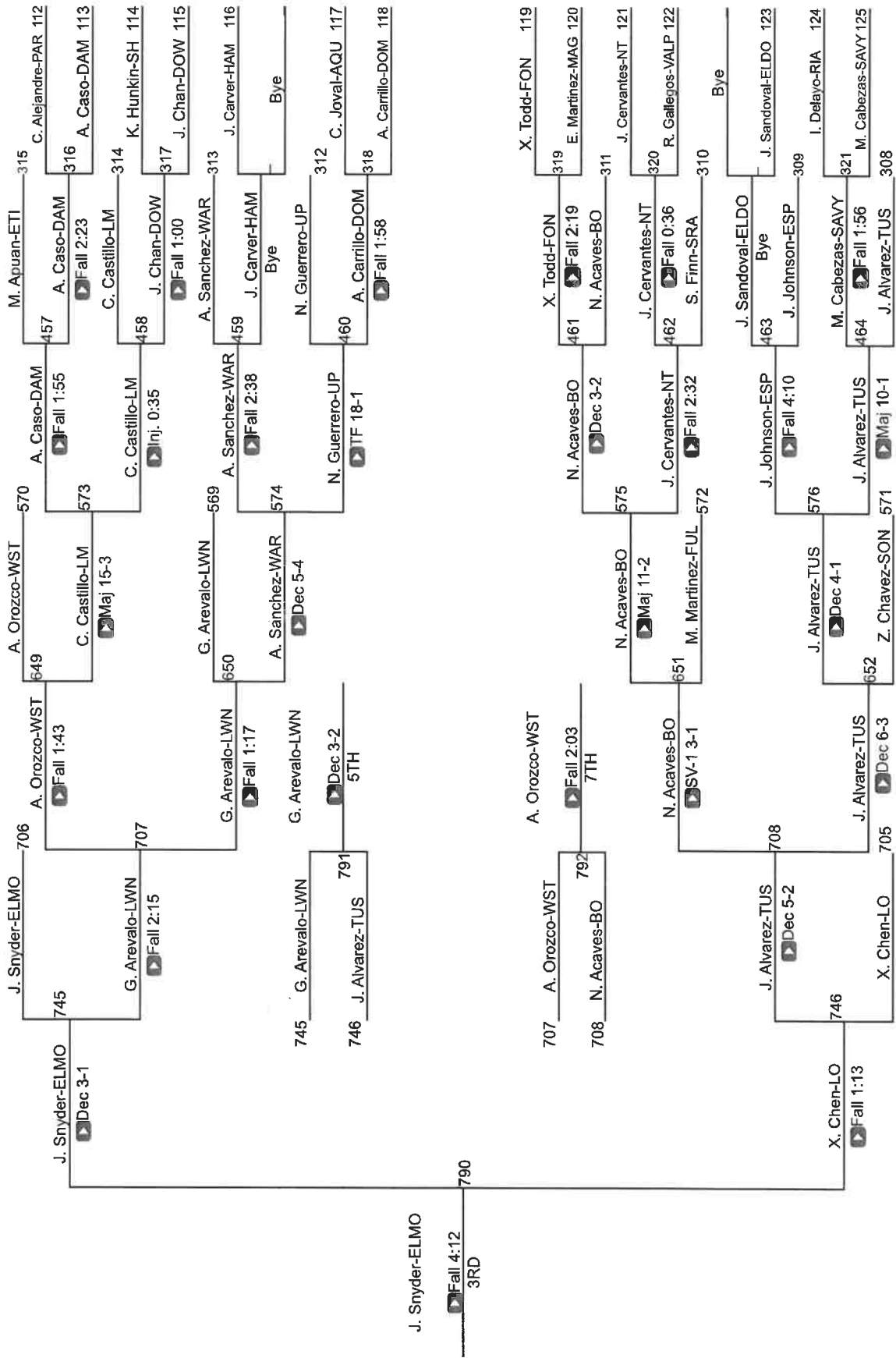

CIF SS Boys Individuals Northern Div

CIF Qualifier 170

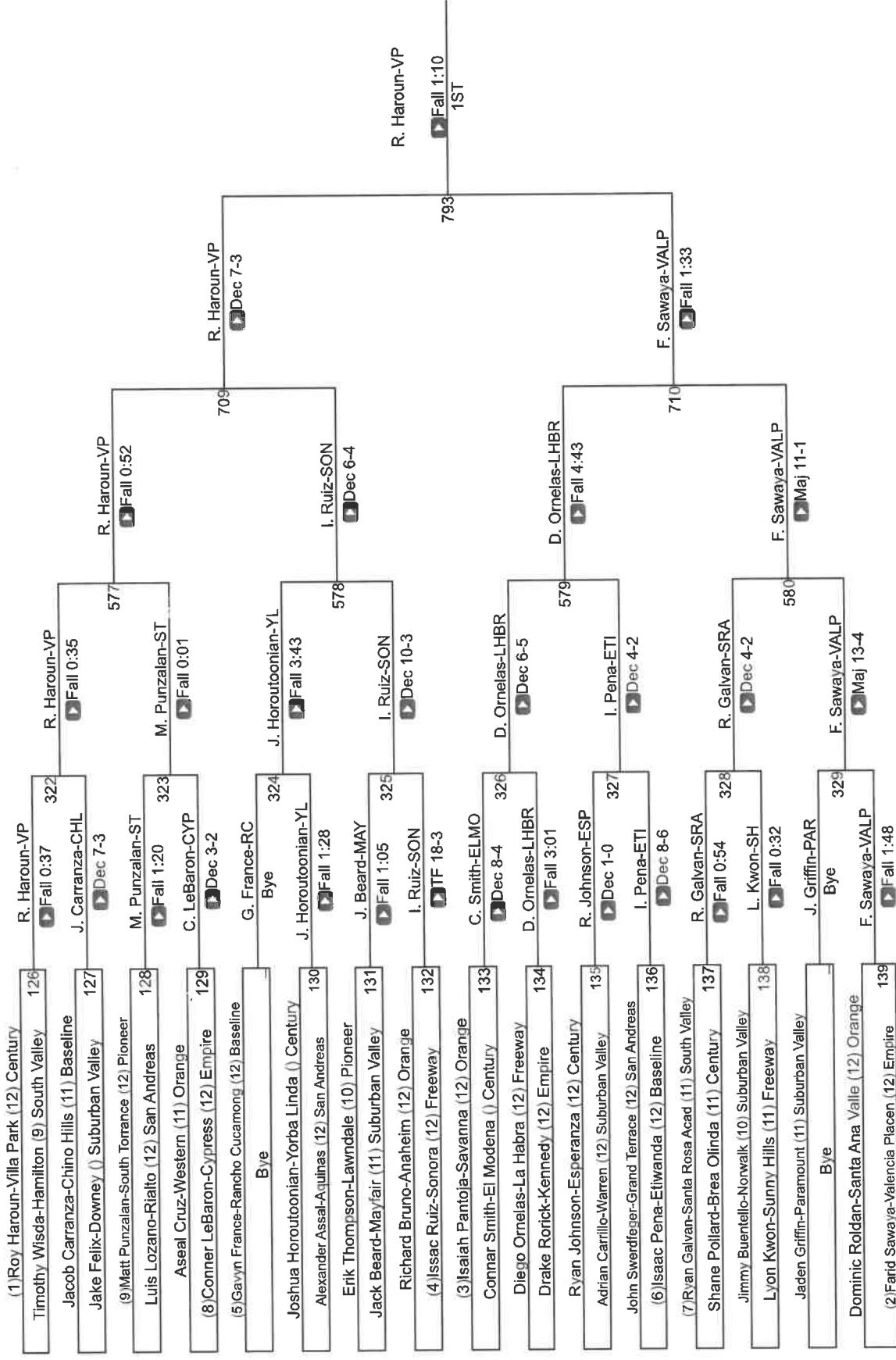

CIF SS Boys Individuals Northern Div

CIF Qualifier 182

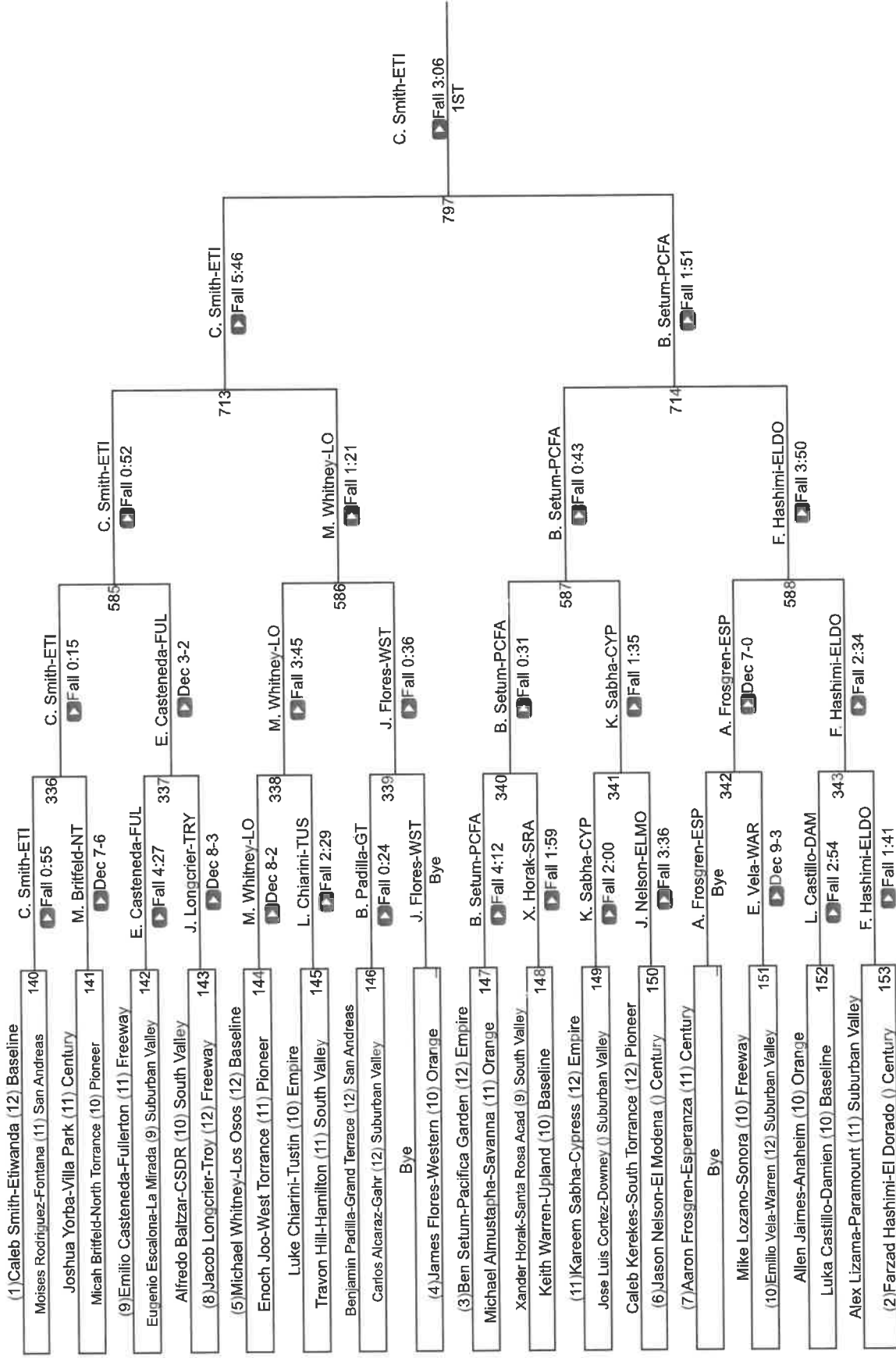

CIF SS Boys Individuals Northern Div

CIF Qualifier 195

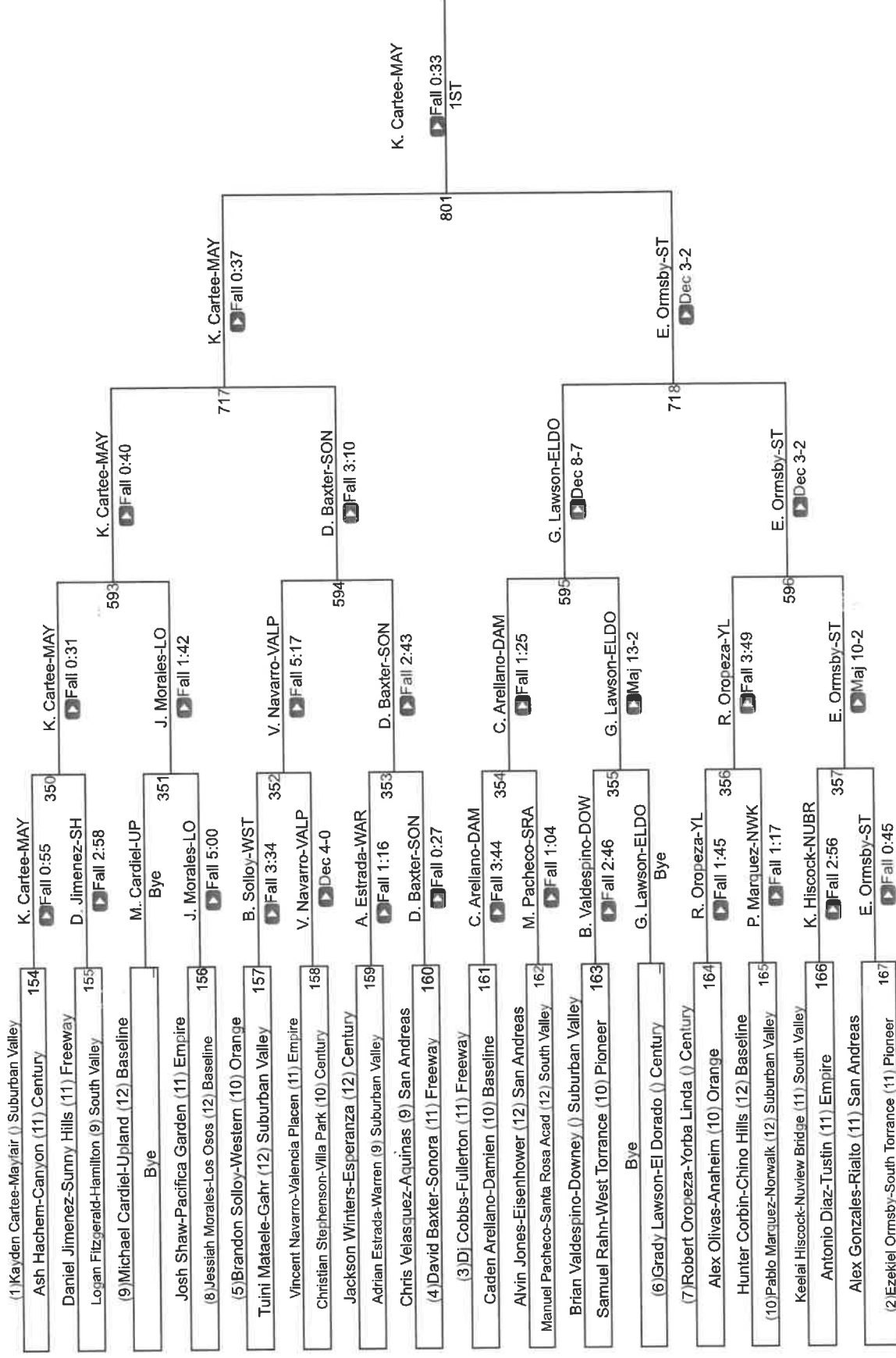

CIF Qualifier 195

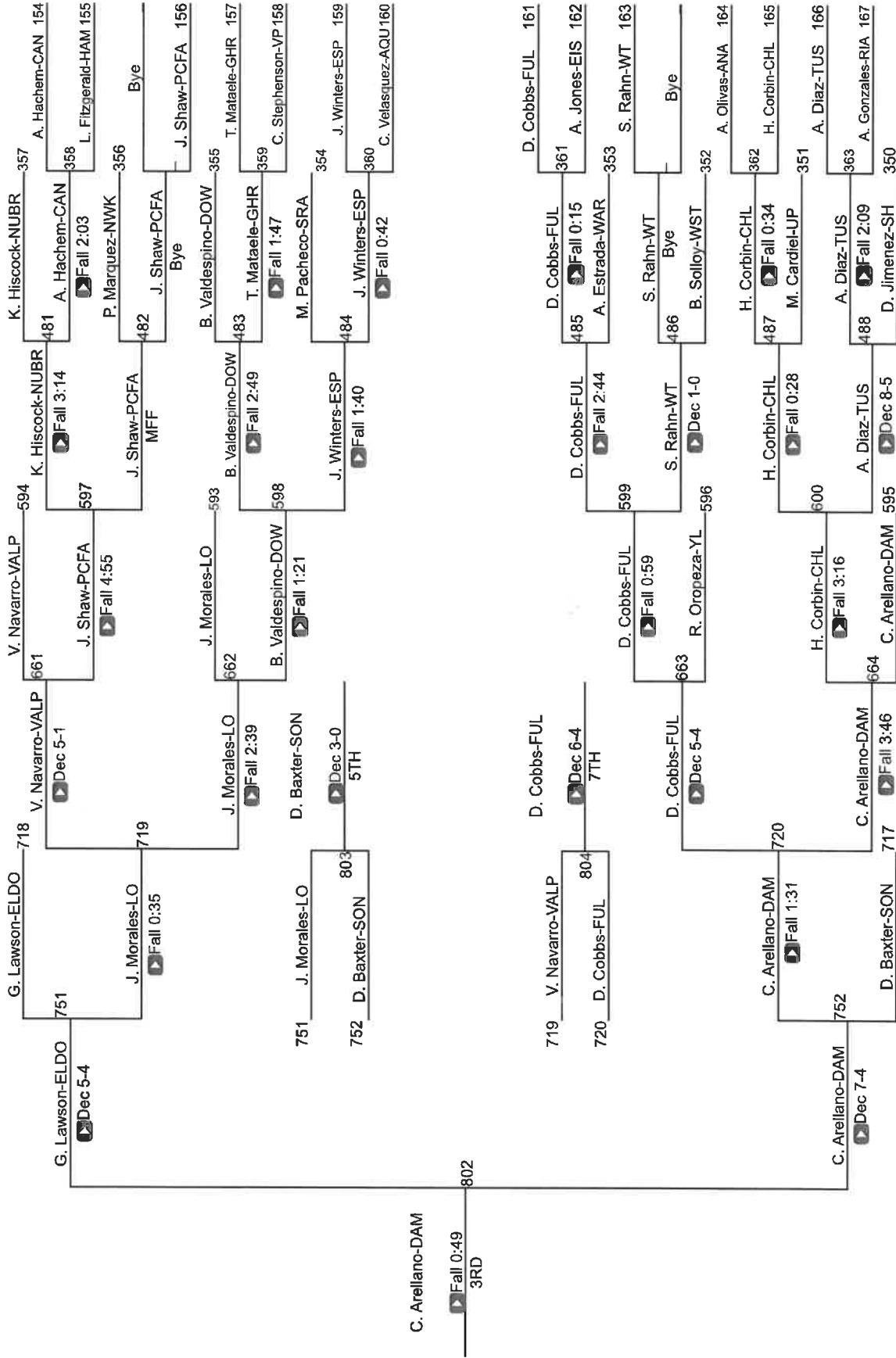

CIF SS Boys Individuals Northern Div

CIF Qualifier 220

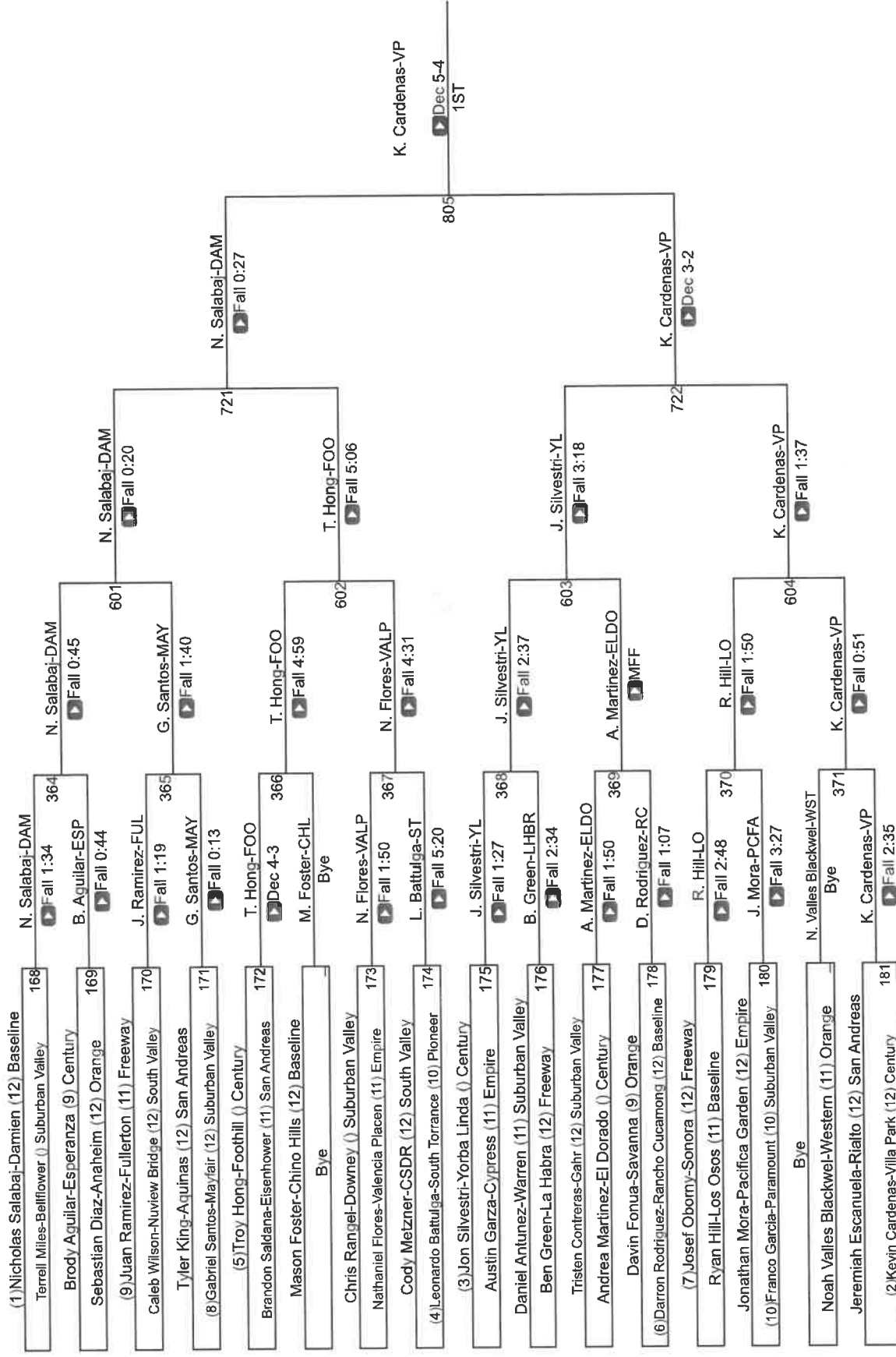

CIF Qualifier 220

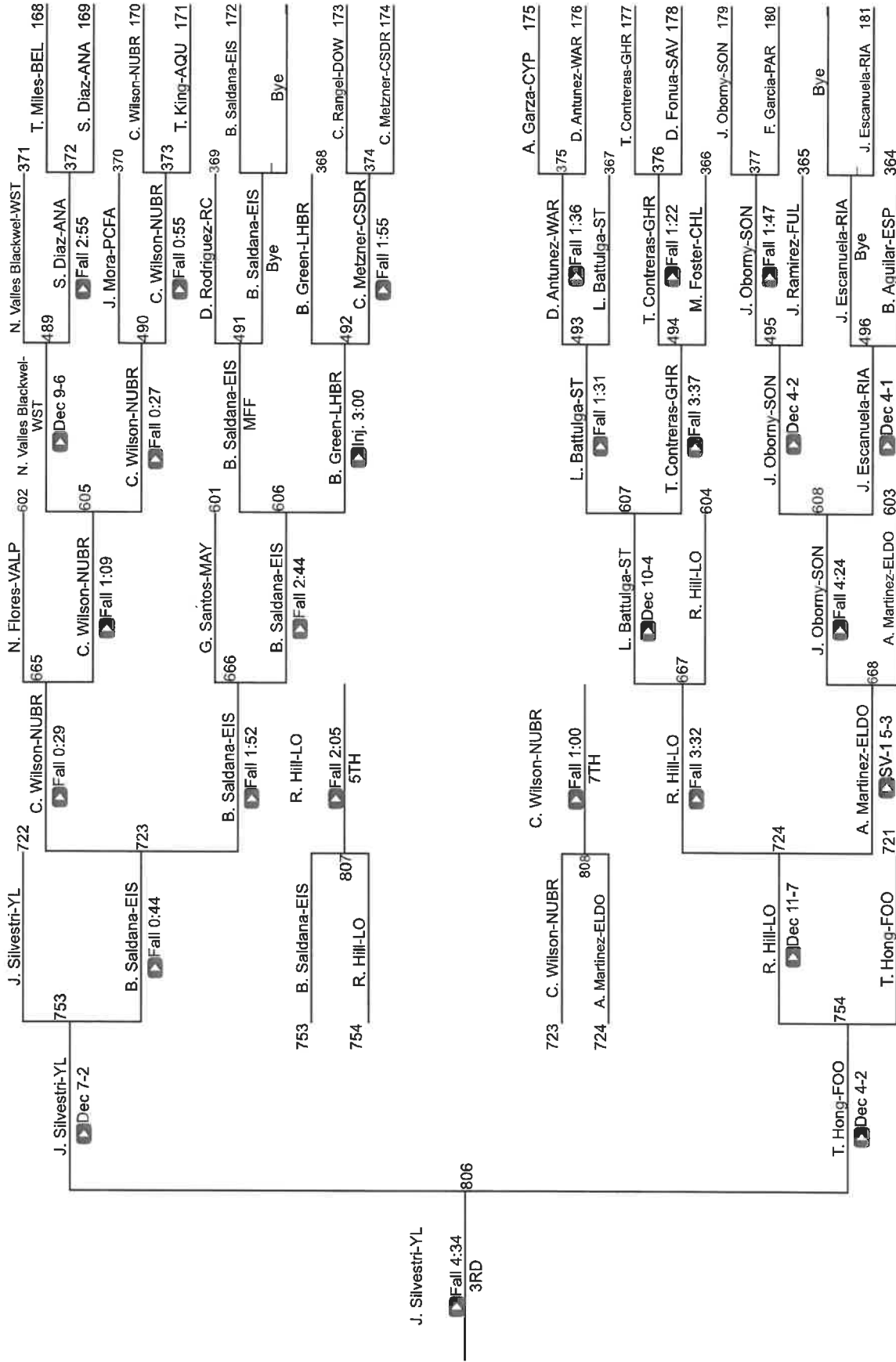

CIF SS Boys Individuals Northern Div

CIF Qualifier 285

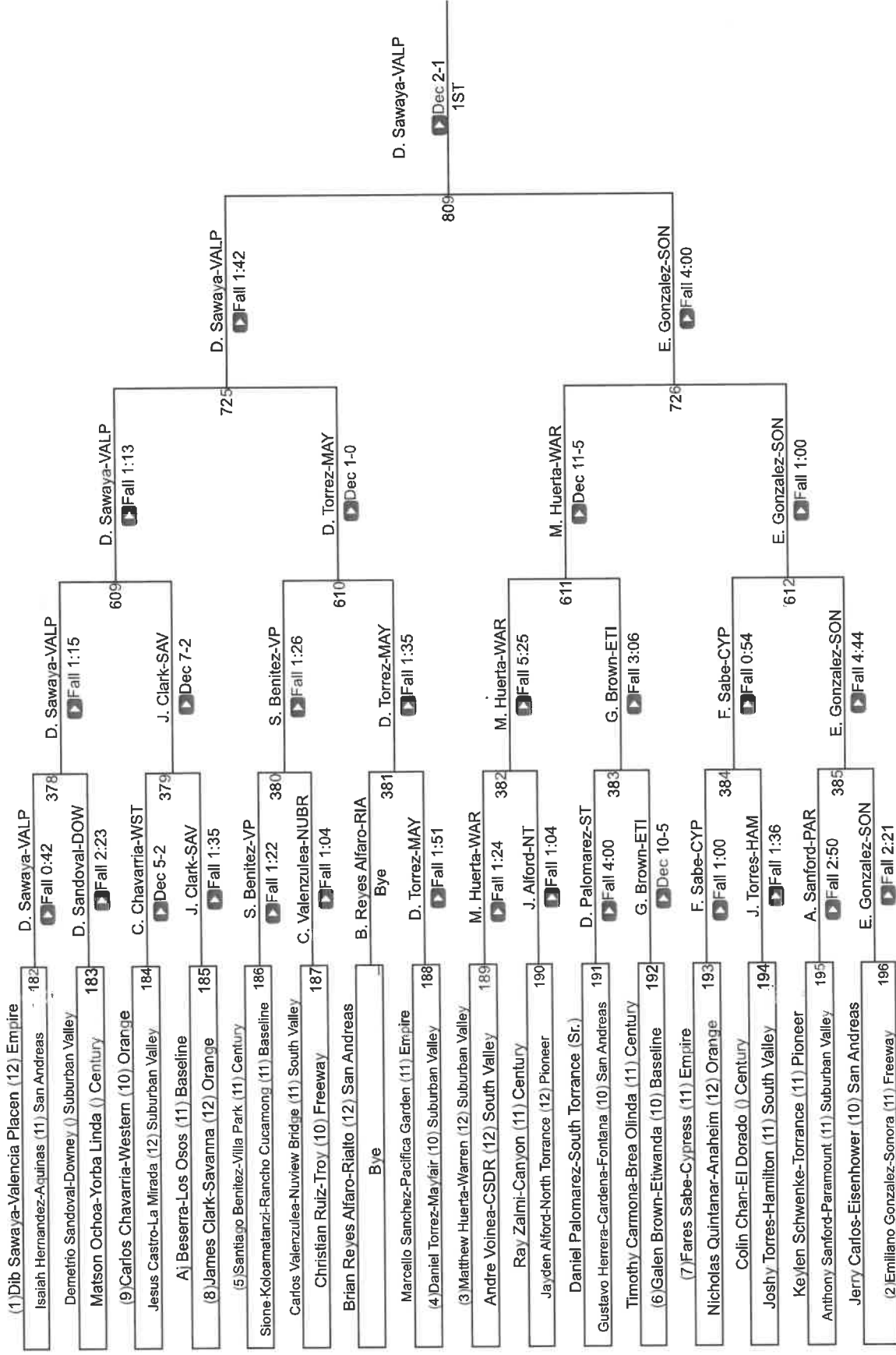

CIF Qualifier 285

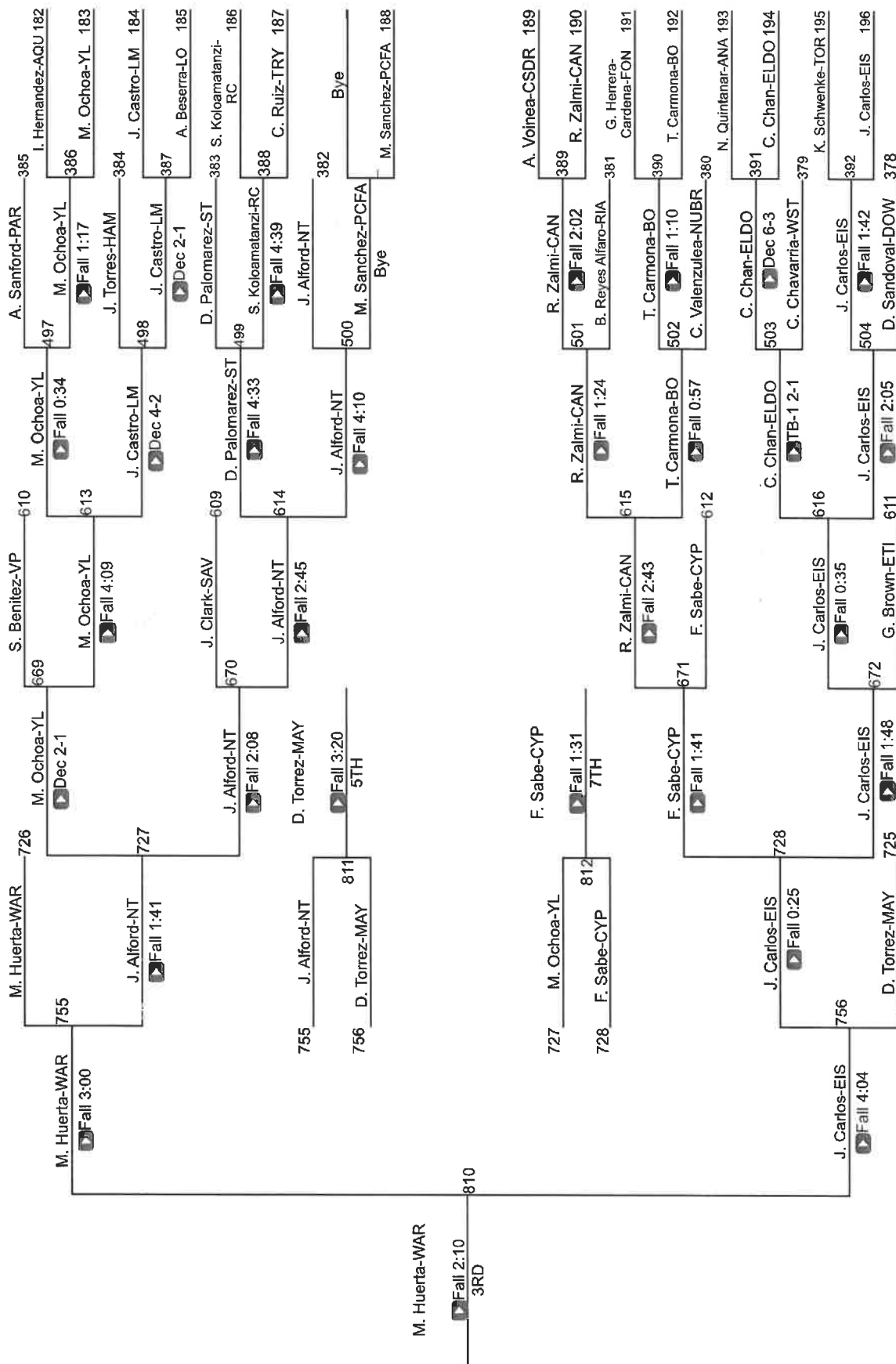

CIF SS Boys Individuals

Southern Division

Murrieta Valley High School

February 10-11, 2023



Lower Weight MVP

Justin Wells
Lakeside
138 Pounds

Upper Weight MVP

Sonny Kling
Canyon Springs
182 Pounds

Placers

106 Pounds			152 Pounds			Team Score Final		
1st	Yousef Jubrail	Chaminade	1st	Kristofer Arrey	Riverside Poly	1	Temecula Valley	278.5
2nd	Leland Hodges	Indio	2nd	Elijah Benavidez	Paloma Valley	2	Paloma Valley	248
3rd	Ethan Padilla	Temescal Canyon	3rd	Harrison Roderick	Crespi	3	Chaminade	225.5
4th	Xavier Manzo	Canyon Springs	4th	Daniel Sterling	Temecula Valley	4	Lakeside	204
5th	Sam Lee	Crespi	5th	Isaiah Rea	Lakeside	5	Canyon Springs	149.5
6th	Tate Lowry	Redondo Union	6th	Tyler Aughenbaugh	Chaparral	6	Chaparral	144
7th	Uriel Cruz	Paloma Valley	7th	Pierce Velker	Millikan	7	JW North	117
8th	Isaiah Trujillo	Temecula Valley	8th	Eden-Jay Khamnoy	Wilson Long Beach	8	Millikan	116
113 Pounds			160 Pounds			9	Vista Murrieta	105.5
1st	Syruss Flores	Paloma Valley	1st	Kris Castro	Chaminade	10	Bishop Amat	102
2nd	Brandon Ryan	Murrieta Valley	2nd	Logan Alawneh	Temecula Valley	11	Redondo Union	80.5
3rd	Benjamin Ruiz	Lakeside	3rd	Gabriel Flores	Cathedral City	12	Great Oak	68
4th	Nathan Itchon	Long Beach Poly	4th	Ivan Natceli	Chaparral	13	Riverside Poly	66.5
5th	Steve Corona	Vista Murrieta	5th	Trey Culwell	Millikan	14	Indio	65
6th	Johnny Martinez	Jurupa Valley	6th	Aiden Platte	Paloma Valley	15	Murrieta Valley	61.5
7th	Nolan Himelfarb	Chaminade	7th	Alexander Lopez	Indian Springs	16	Crespi	58
8th	Jacob Jenner	Wilson Long Beach	8th	Nathan Riedell	Riverside Poly	17	Murrieta Mesa	55
120 Pounds			170 Pounds			18	Long Beach Poly	50
1st	Aidan Munoz	Temecula Valley	1st	Kameron Phillips	Temecula Valley	19	Santa Monica	50
2nd	Michael Kase	Chaminade	2nd	Javon Major	Paloma Valley	20	Wilson Long Beach	50
3rd	Onelo Lorberter	Chaparral	3rd	Daniel Mendoza	Hemet	21	Coachella Valley	49
4th	Chase Carrasco	Lakeside	4th	Wyatt Toth	Great Oak	22	Sierra Vista	49
5th	Eduardo Sandoval	Long Beach Poly	5th	Ryan Kraven	Millikan	23	Cathedral City	48
6th	Kyan Wong	Redondo Union	6th	Boris Guardado	JW North	24	Hemet	47.5
7th	Paul Fierro	Elsinore	7th	Jeremiah Pimentel	Coachella Valley	25	Rubidoux	41
8th	Justin Brown	Paloma Valley	8th	Eli Gould	Canyon Springs	26	Temescal Canyon	39
126 Pounds			182 Pounds			27	Beverly Hills	33.5
1st	Richard Murillo	Canyon Springs	1st	Sonny Kling	Canyon Springs	28	Jurupa Valley	29
2nd	Ryan Lobato	Lakeside	2nd	Primo Catalano	Chaminade	29	AB Miller	28
3rd	Justin Herrera	Chaparral	3rd	Bryan Romero	JW North	30	Elsinore	28
4th	Gavin Laverde	Millikan	4th	John O'Brien	Alemany	31	Alemany	24
5th	Gabriel Lemos	Temecula Valley	5th	Koen Blank	Great Oak	32	Lakewood	24
6th	Lucas Coumeya	Beverly Hills	6th	Dylan Natceli	Chaparral	33	Heritage	21
7th	Draw Perlmutter	Chaminade	7th	Daniel Diaz	Paloma Valley	34	Desert Hot Springs	18
8th	Jake Barnes	Paloma Valley	8th	Reese Bradley	Vista Murrieta	35	Mira Costa	16.5
132 Pounds			195 Pounds			36	Harvard-Westlake	16
1st	Malikhi Espiritu	Temecula Valley	1st	Matthew Porras-Diamond	Temecula Valley	37	Indian Springs	15
2nd	Slava Shahbazyan	Chaminade	2nd	Kevin Rodriguez	Chaminade	38	Jordan	15
3rd	Axel Esparza	Lakeside	3rd	Noah Bode	Vista Murrieta	39	Yucca Valley	10.5
4th	Allister Castillo	Millikan	4th	Khaled Hussein	Canyon Springs	40	Peninsula	8
5th	Ty Greer	Murrieta Valley	5th	Benyamin Sohrab	Paloma Valley	41	Desert Mirage	7
6th	Gabriel Canela	Chaparral	6th	Uriel Garibay	Rubidoux	42	Workman	7
7th	Christian Cruz	Crespi	7th	Armando Serrano	Sierra Vista	43	Gladstone	5
8th	Dominic Ruiz	Riverside Poly	8th	Thomas Cook	Riverside Poly	44	Duarte	4
138 Pounds			220 Pounds			45	Webb	4
1st	Justin Wells	Lakeside	1st	Simon Flores	Paloma Valley	46	Nogales	3
2nd	Jacob Arvizo	Murrieta Mesa	2nd	Kevin Velazquez	Vista Murrieta	47	Pacific	2
3rd	Cristian Mier	Paloma Valley	3rd	Manamour Ohi	Lakeside	48	Azusa	0
4th	Marvin Morton	Temecula Valley	4th	Ifeanyi Onye	Murrieta Mesa	49	Banning	0
5th	Christian Doering	Hemet	5th	Vaughn Taylor	Chaparral	50	Cabrillo (Long Beach)	0
6th	Isreal Dunn	Canyon Springs	6th	Chase Bergeson	Temecula Valley	51	Compton	0
7th	Aaron Martinez	JW North	7th	Tannor Costello	Millikan	52	Harvard Westlake	0
8th	Julian Lee	Millikan	8th	Moises Laguna	Jurupa Valley	53	San Bernardino	0
145 Pounds			285 Pounds					
1st	Spencer Von Savoye	Chaminade	1st	Ryan Castillo	Bishop Amat			
2nd	Luca Munoz	Bishop Amat	2nd	Thomas Tarascio	JW North			
3rd	Isaac Rea	Lakeside	3rd	Justice ElSayad	Temecula Valley			
4th	Ashton Lassig	Temecula Valley	4th	Jose Soltero	Rubidoux			
5th	Niko Valenzuela	Redondo Union	5th	Miguel Saldana	Indio			
6th	Kai Necci	Santa Monica	6th	Mason Oliva	Santa Monica			
7th	Alexander Lovato	Millikan	7th	Christopher Flores	Paloma Valley			
8th	Jose Jimenez	Paloma Valley	8th	MaCaleb Turner	Murrieta Valley			

CIF SS Boys Individuals Southern Div

CIF Qualifier 106

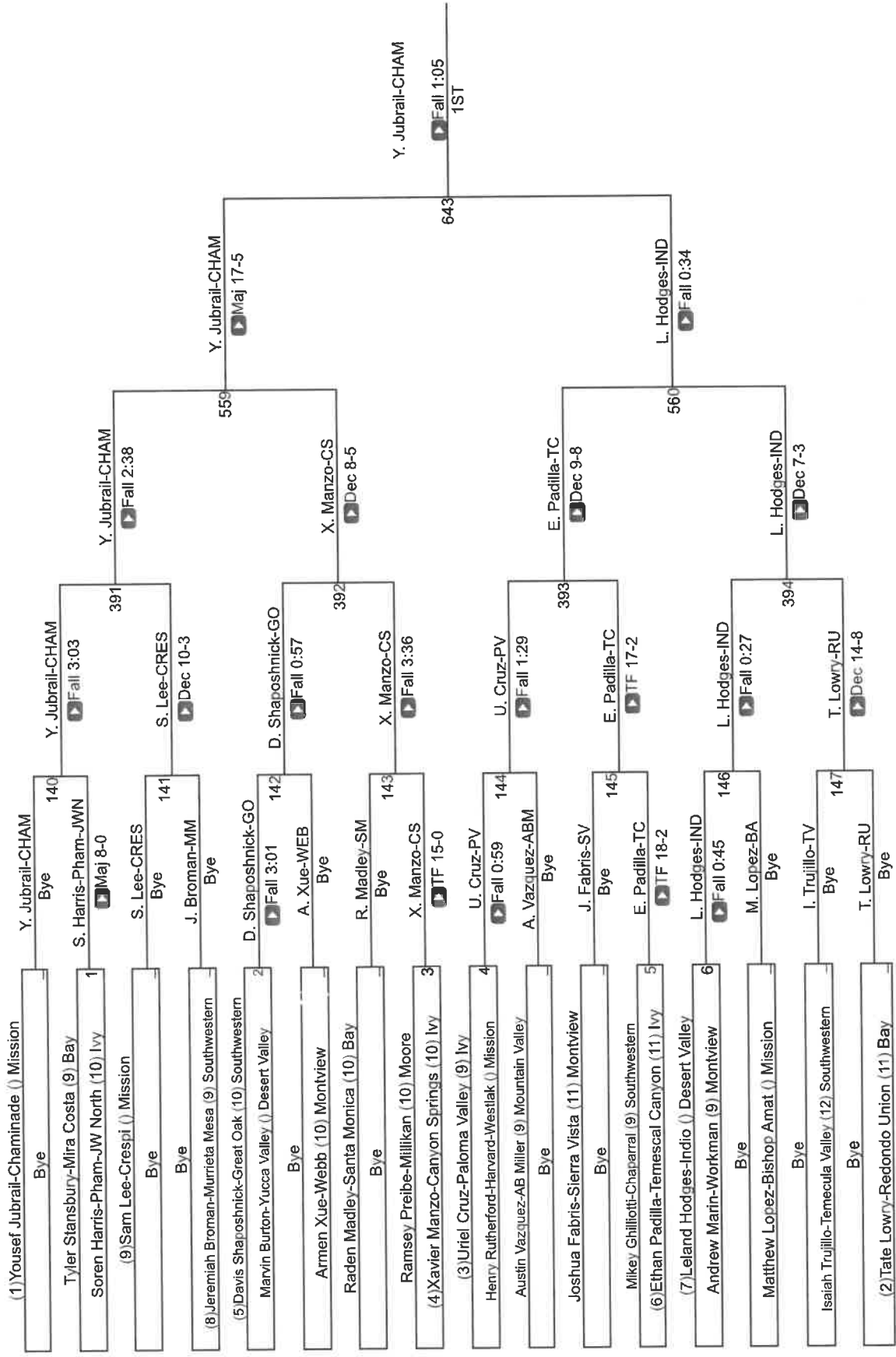

CIF SS Boys Individuals Southern Div

CIF Qualifier 113

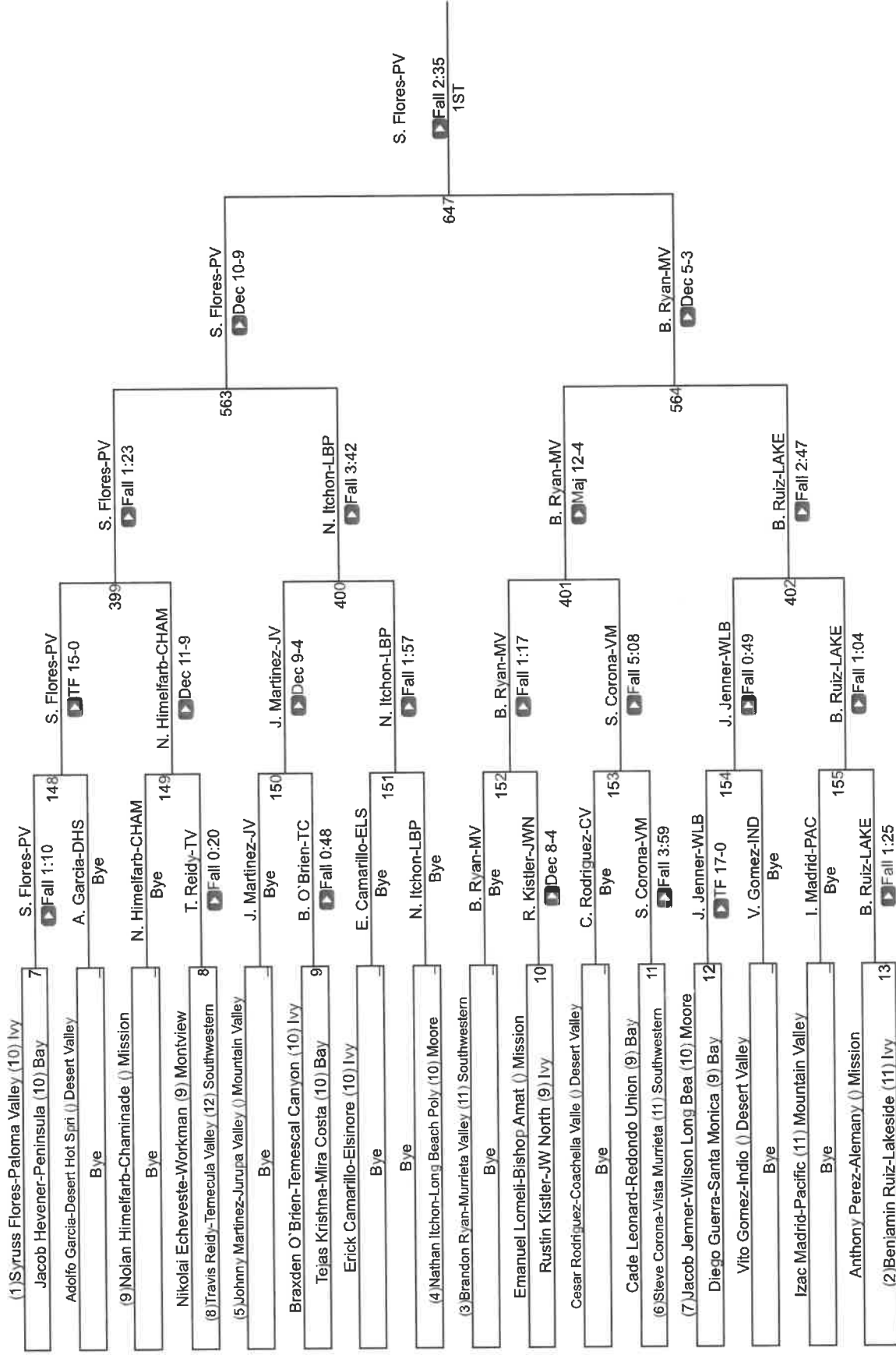

CIF SS Boys Individuals Southern Div

CIF Qualifier 120

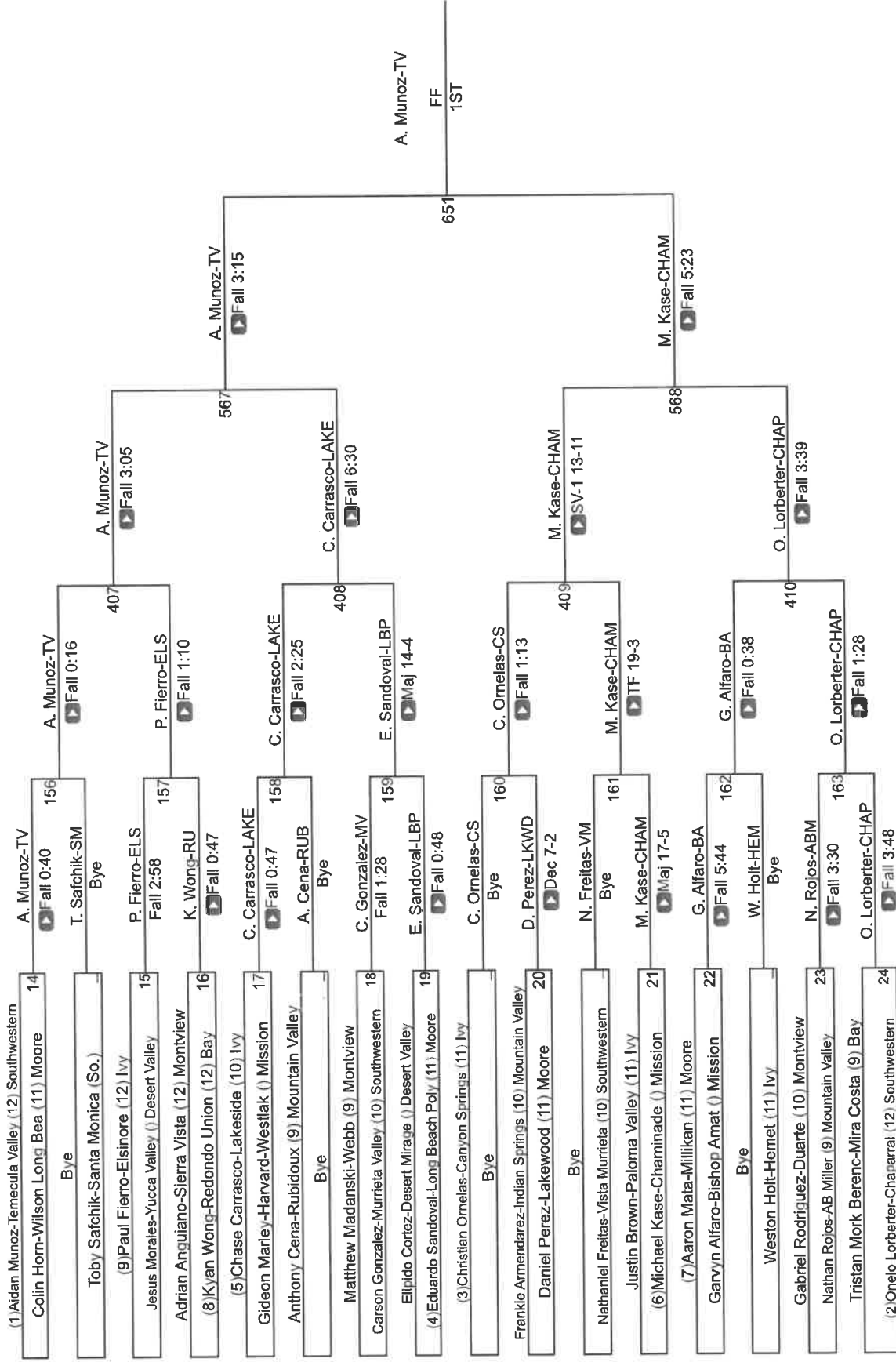

CIF Qualifier 120

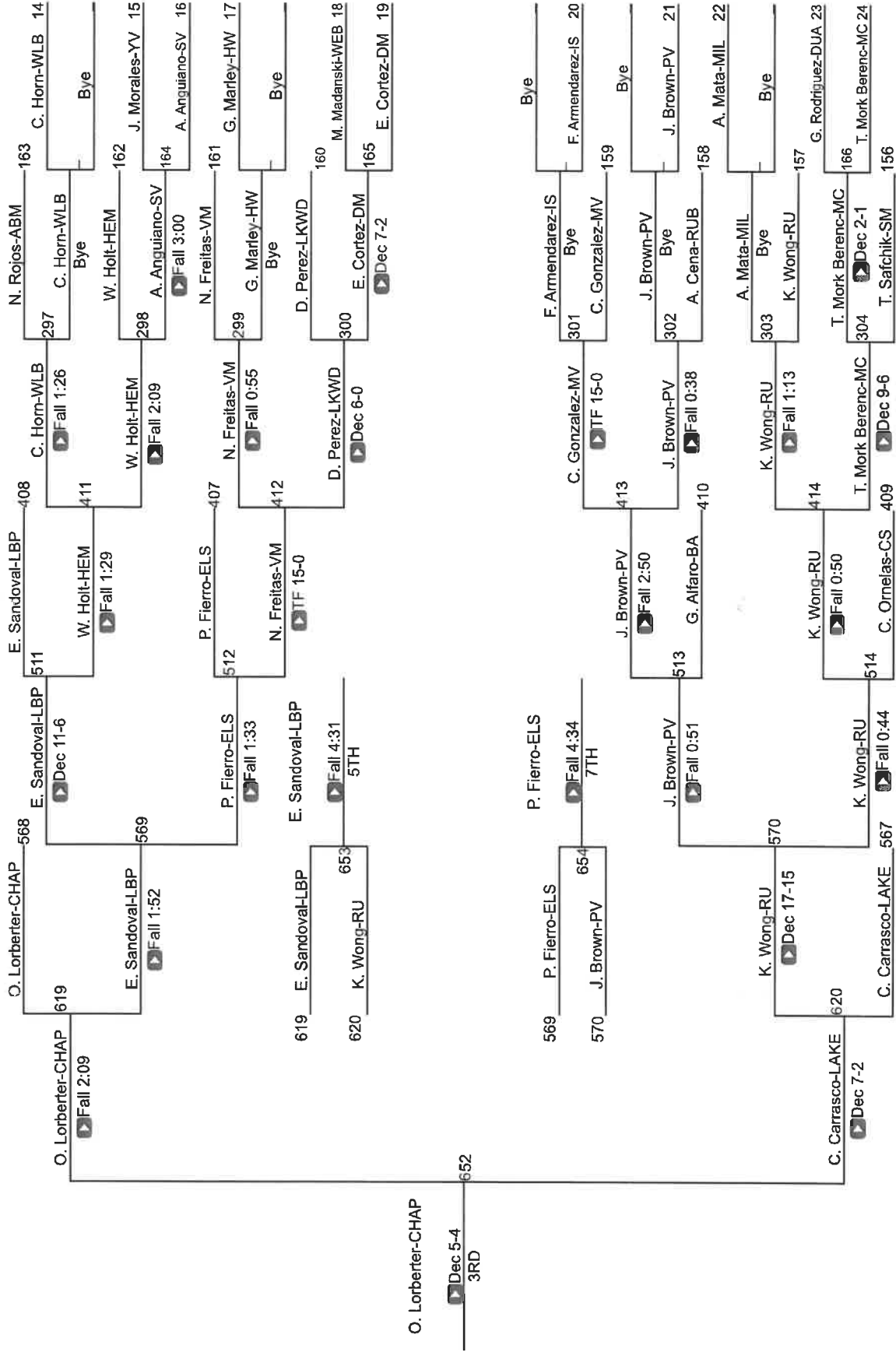

CIF SS Boys Individuals Southern Div

CIF Qualifier 126

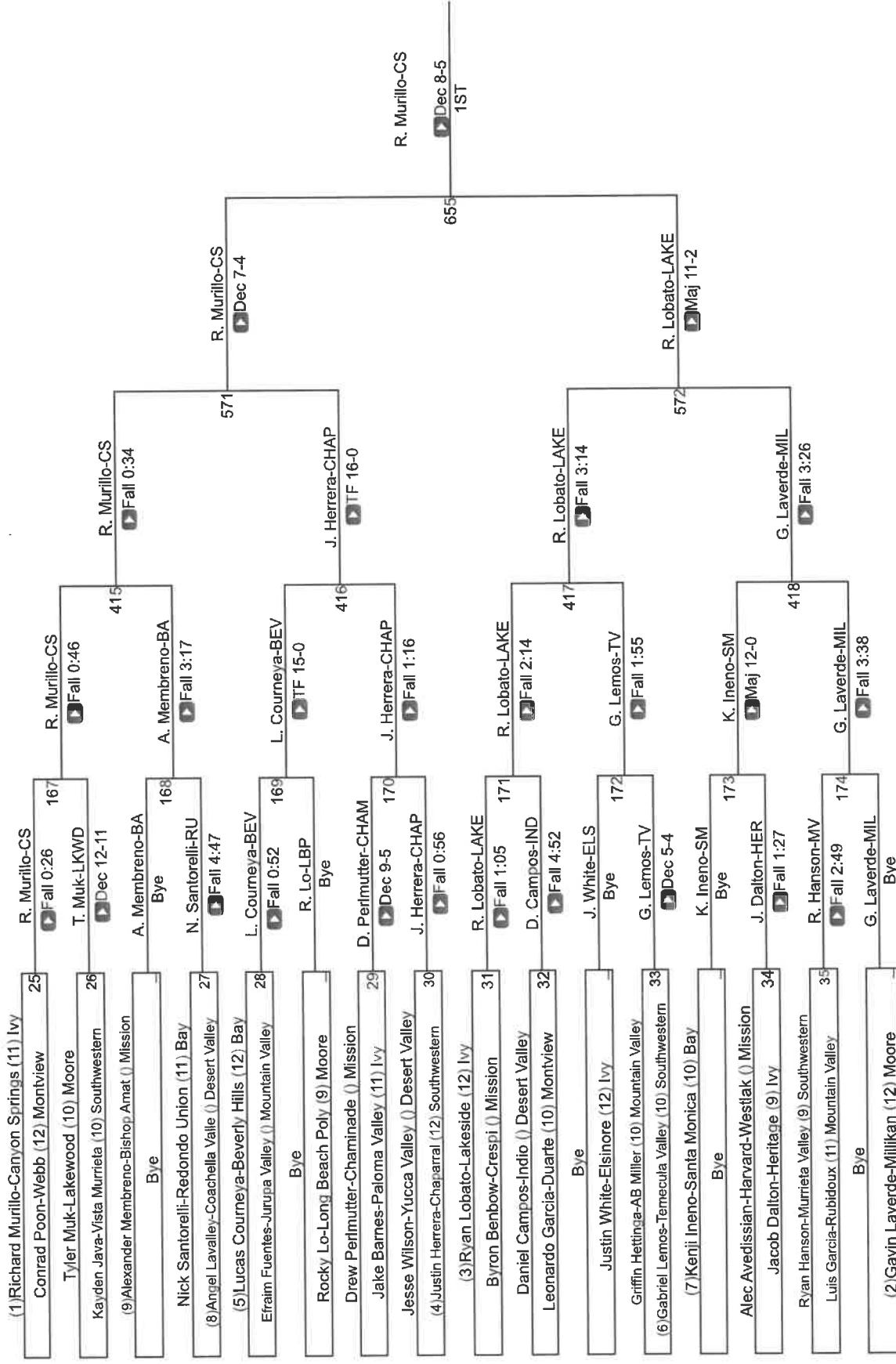

CIF Qualifier 126

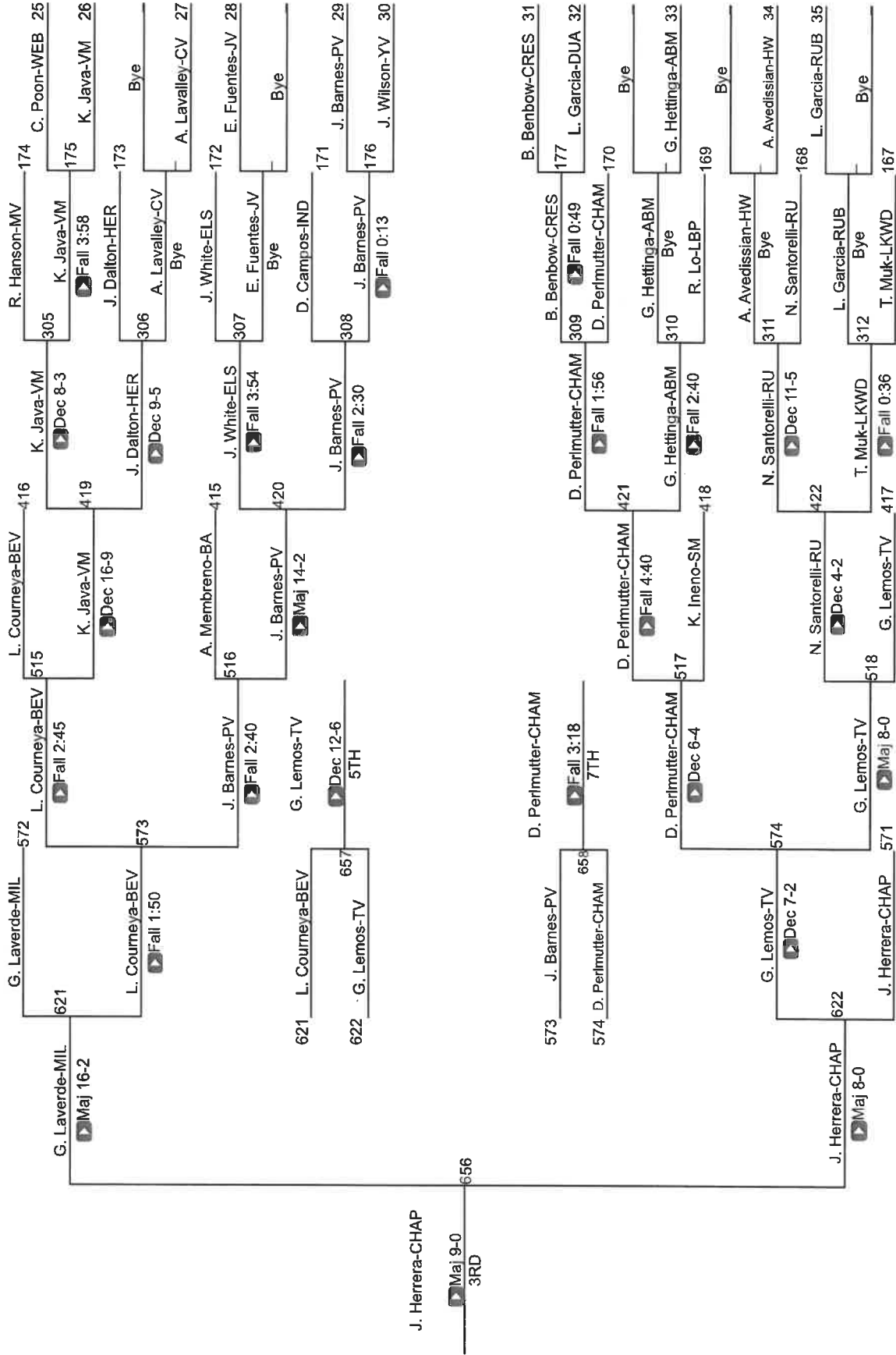

CIF SS Boys Individuals Southern Div

CIF Qualifier 132

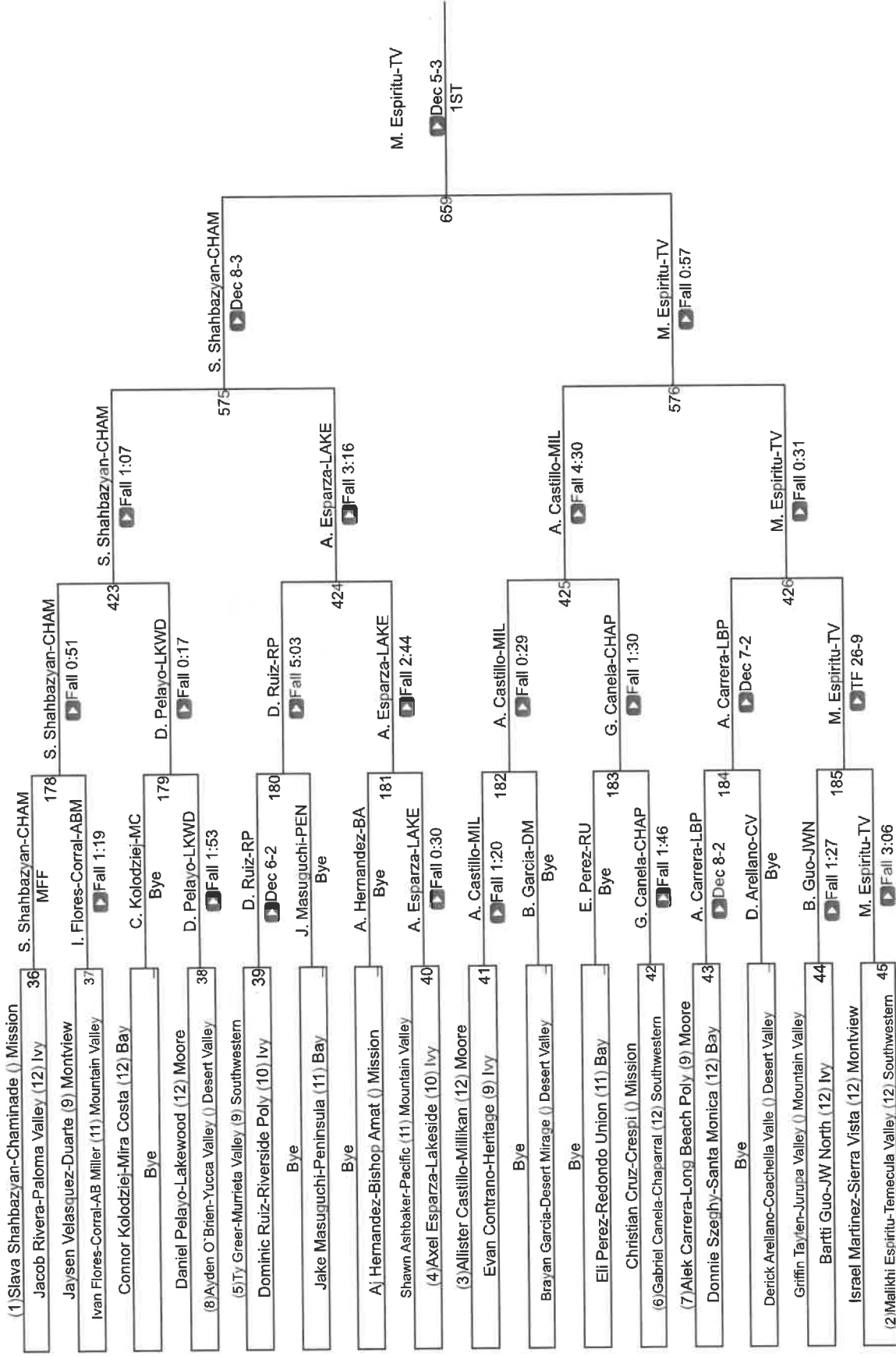

CIF SS Boys Individuals Southern Div

CIF Qualifier 138

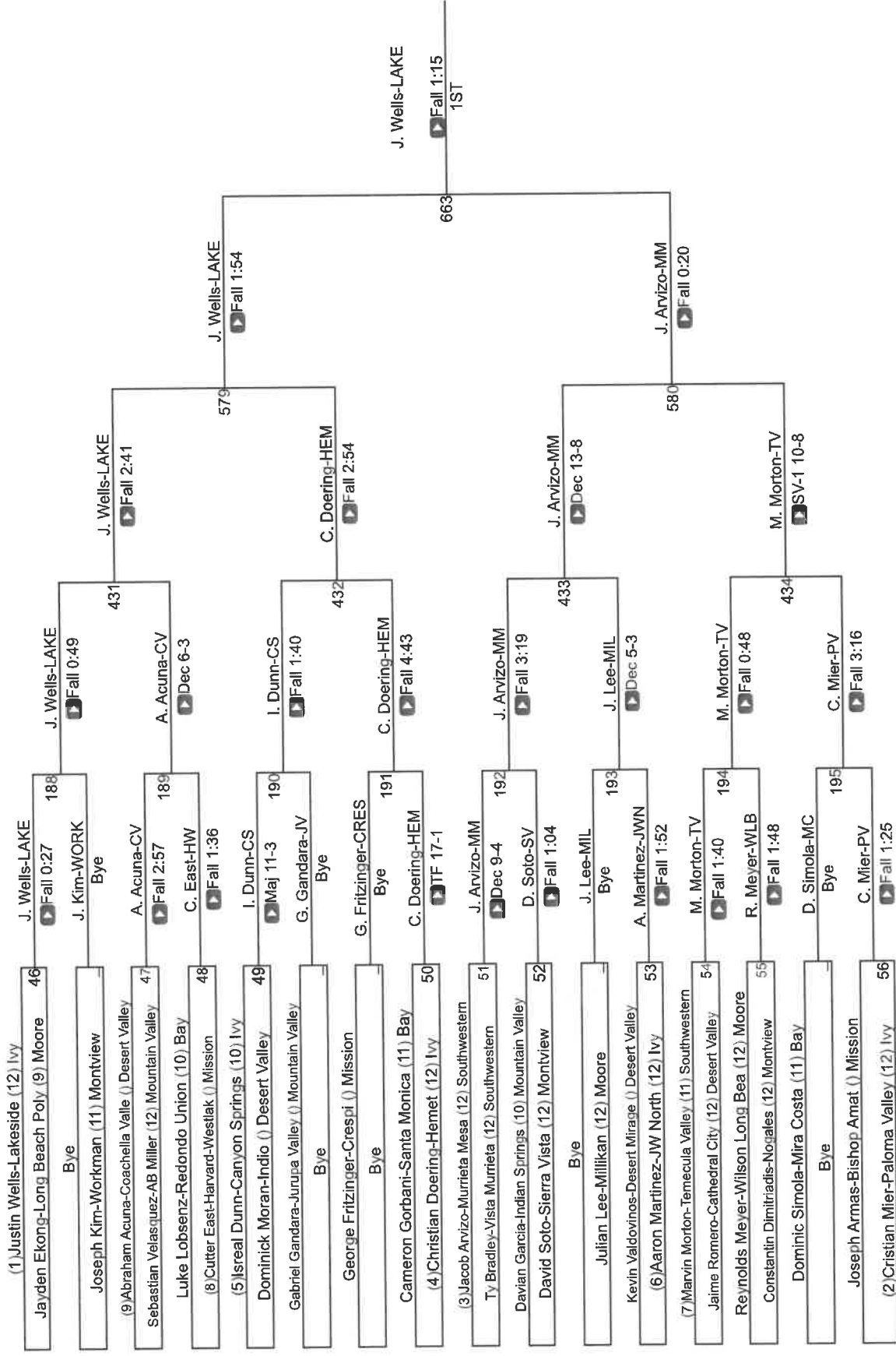

CIF Qualifier 138

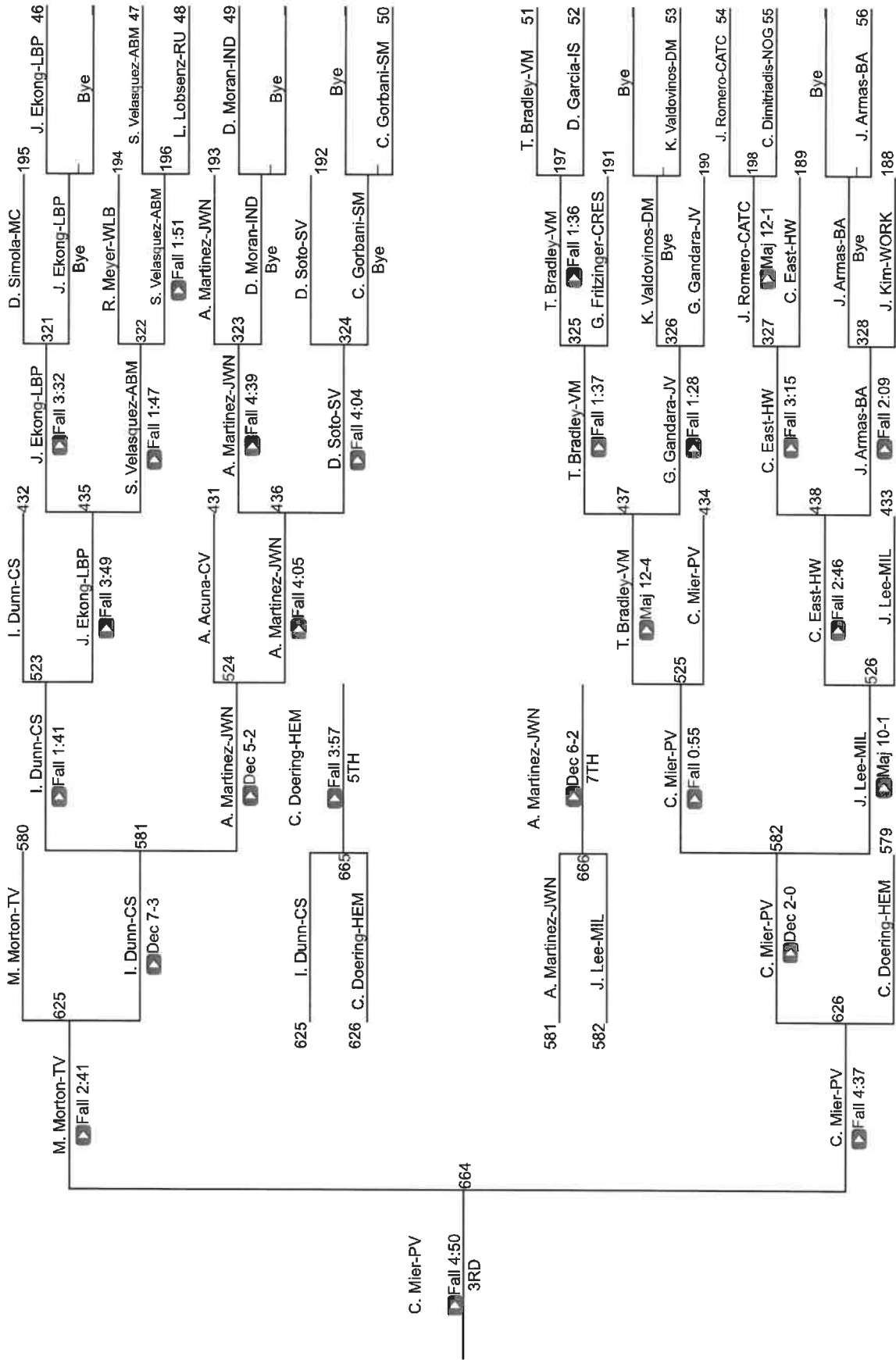

CIF SS Boys Individuals Southern Div

CIF Qualifier 145

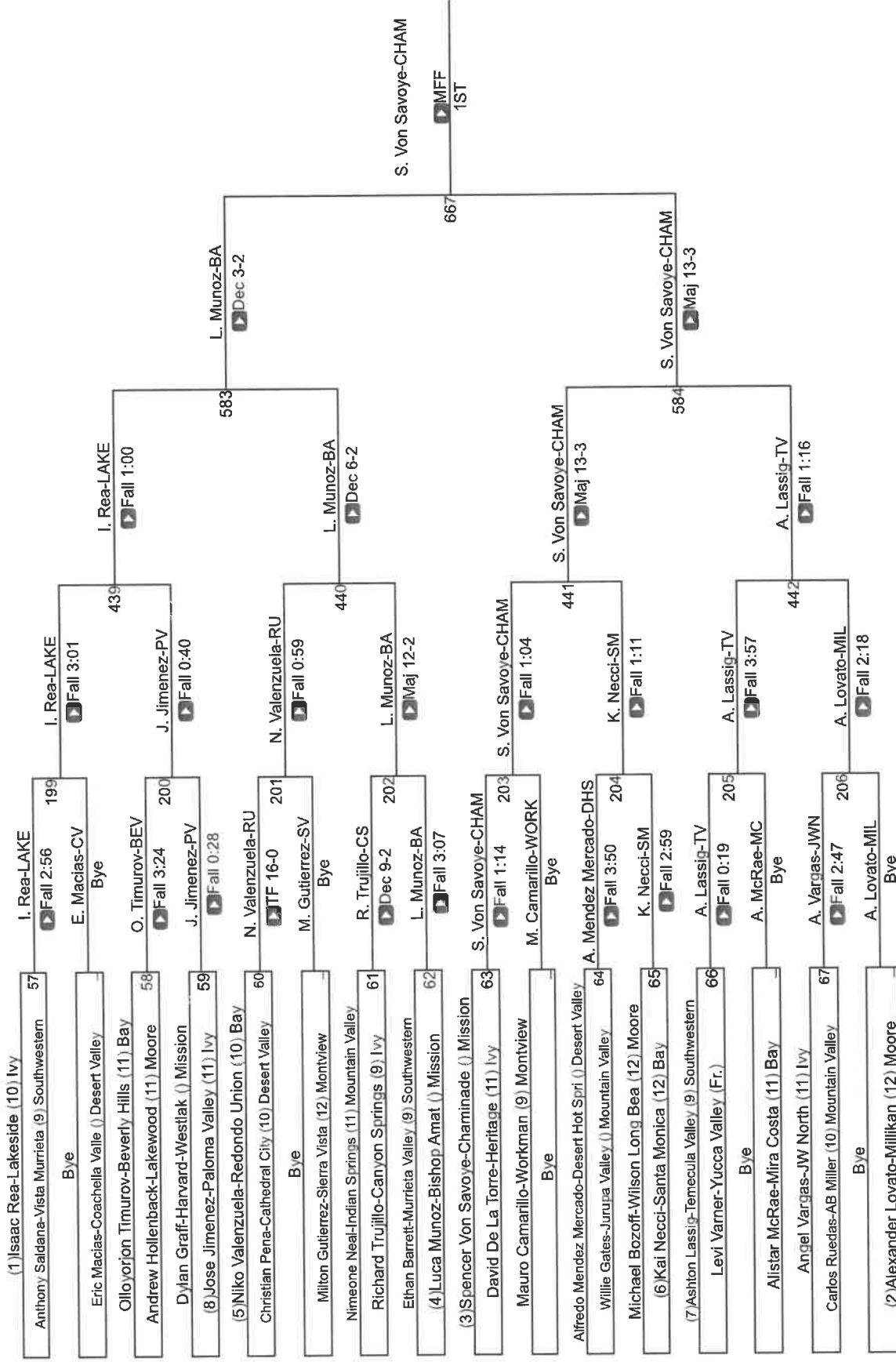

CIF SS Boys Individuals Southern Div

CIF Qualifier 152

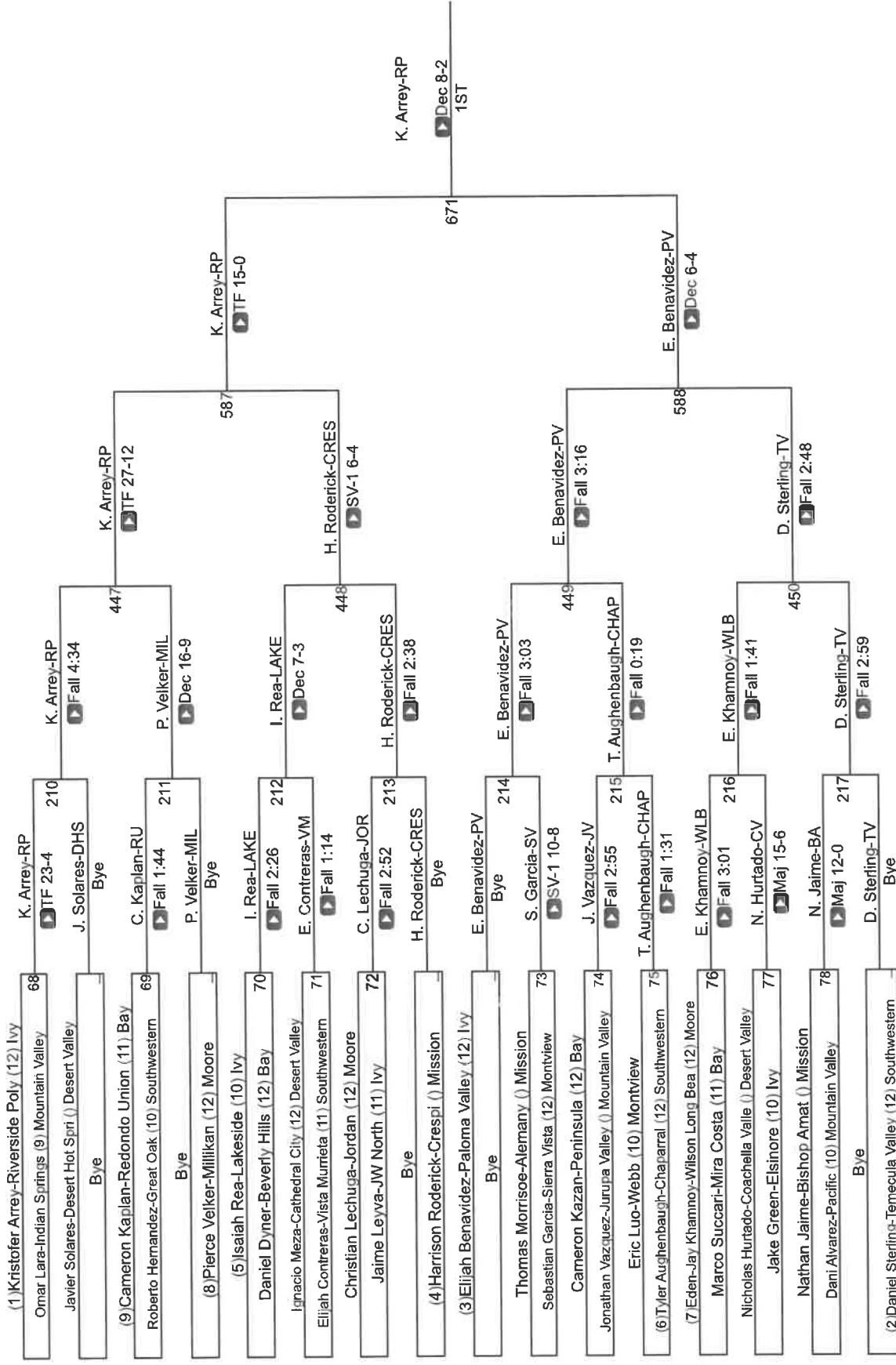

CIF SS Boys Individuals Southern Div

CIF Qualifier 160

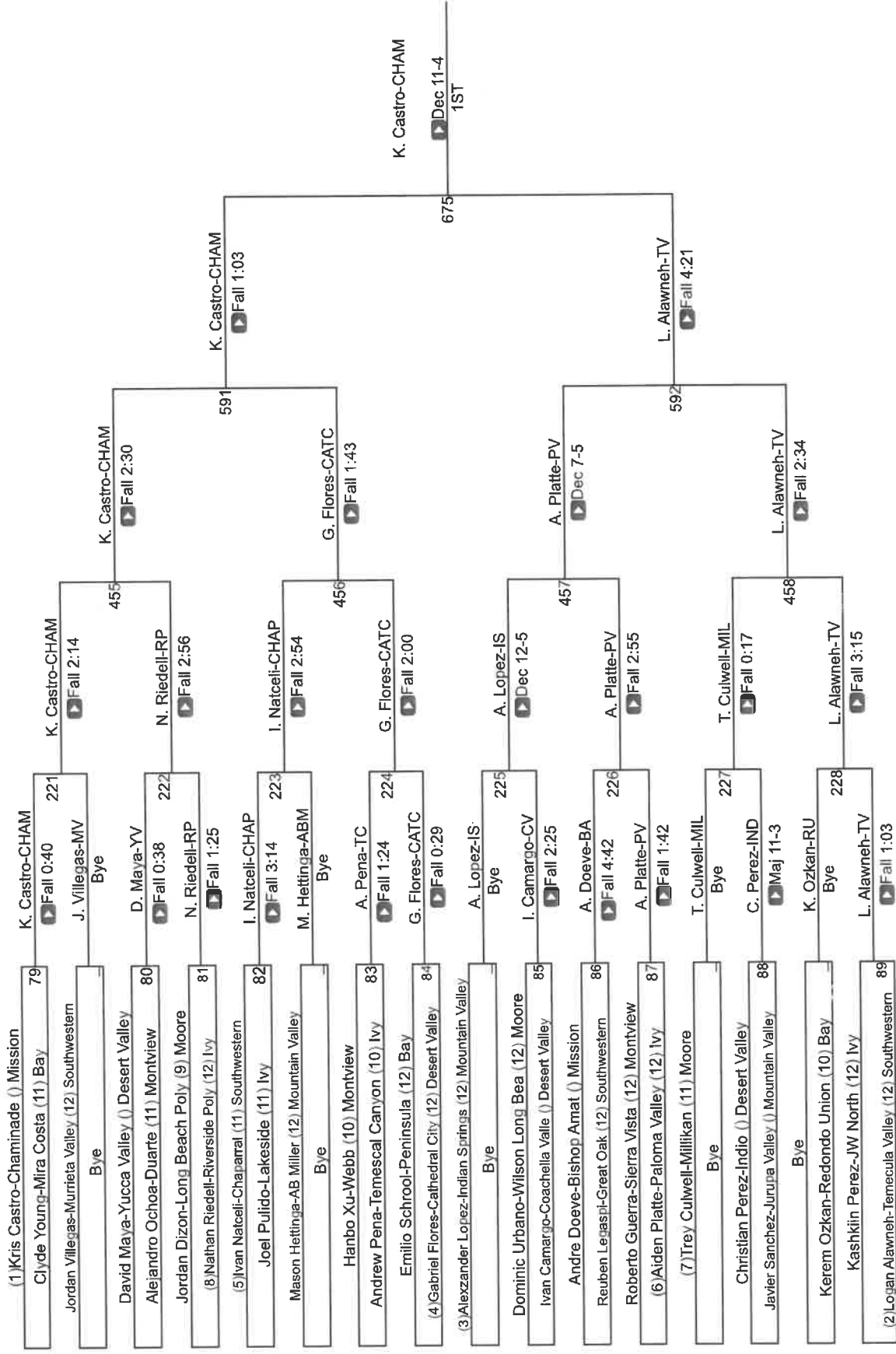

CIF SS Boys Individuals Southern Div

CIF Qualifier 170

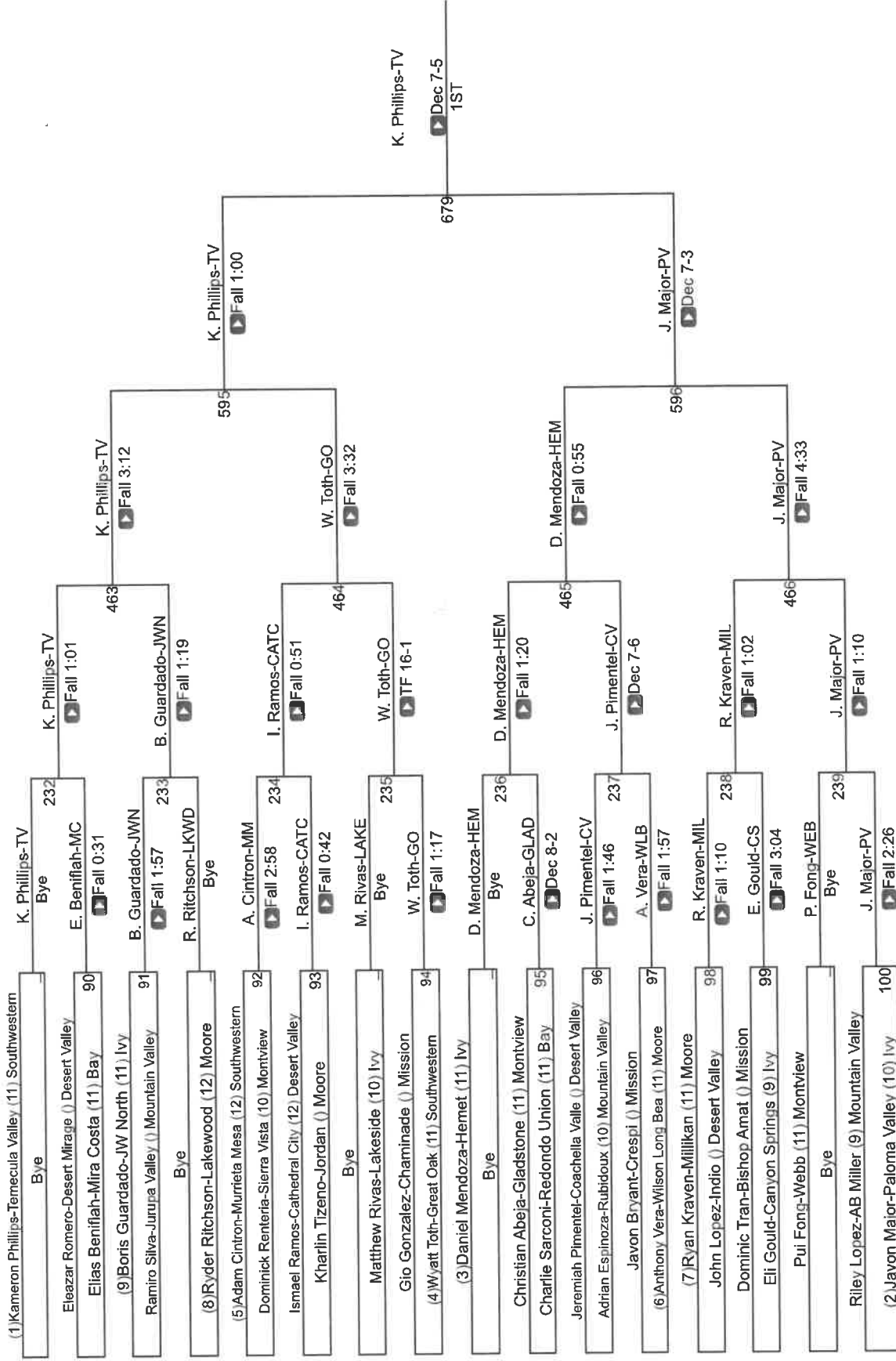

EIF Qualifier 170

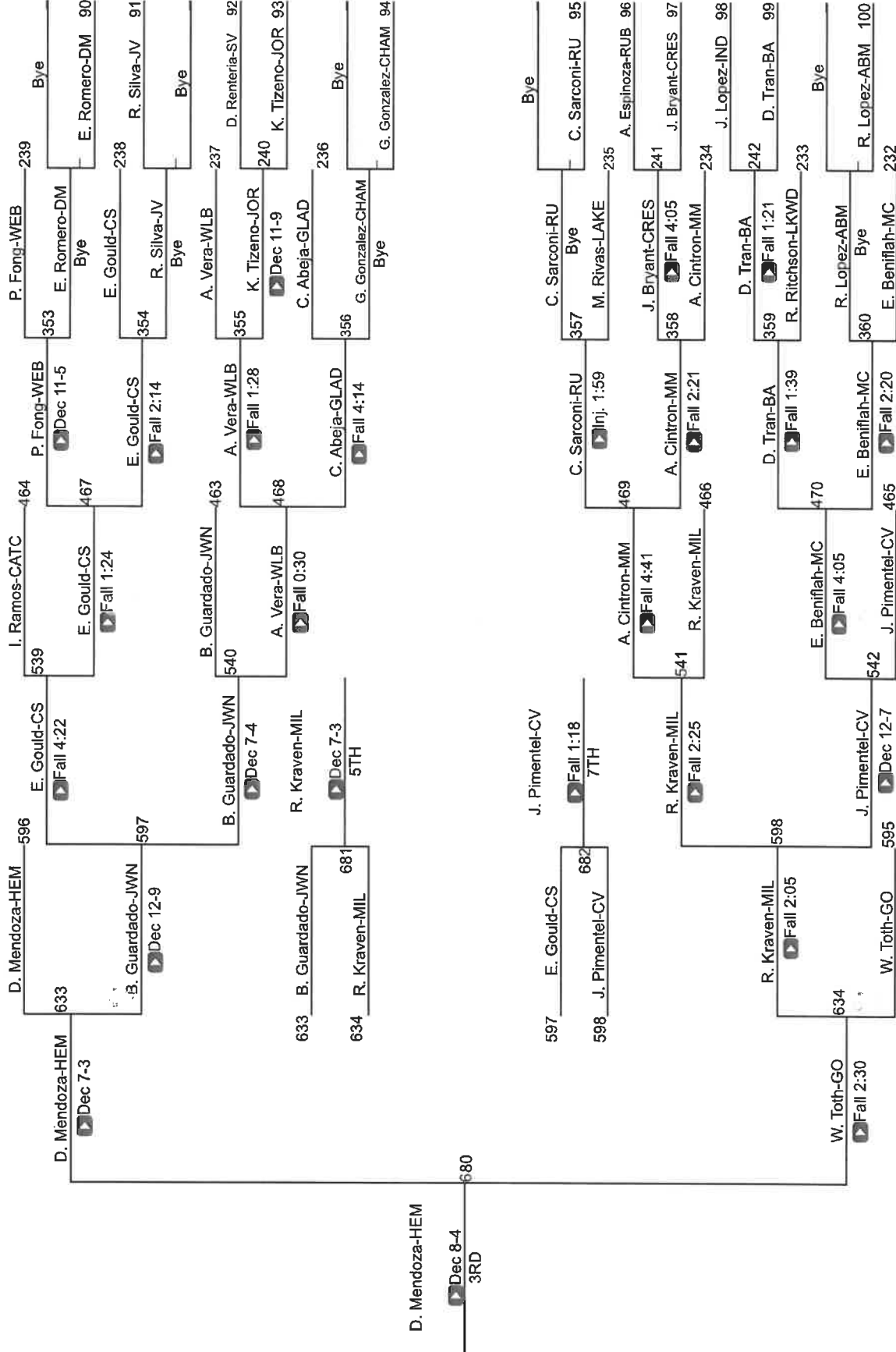

CIF SS Boys Individuals Southern Div

CIF Qualifier 182

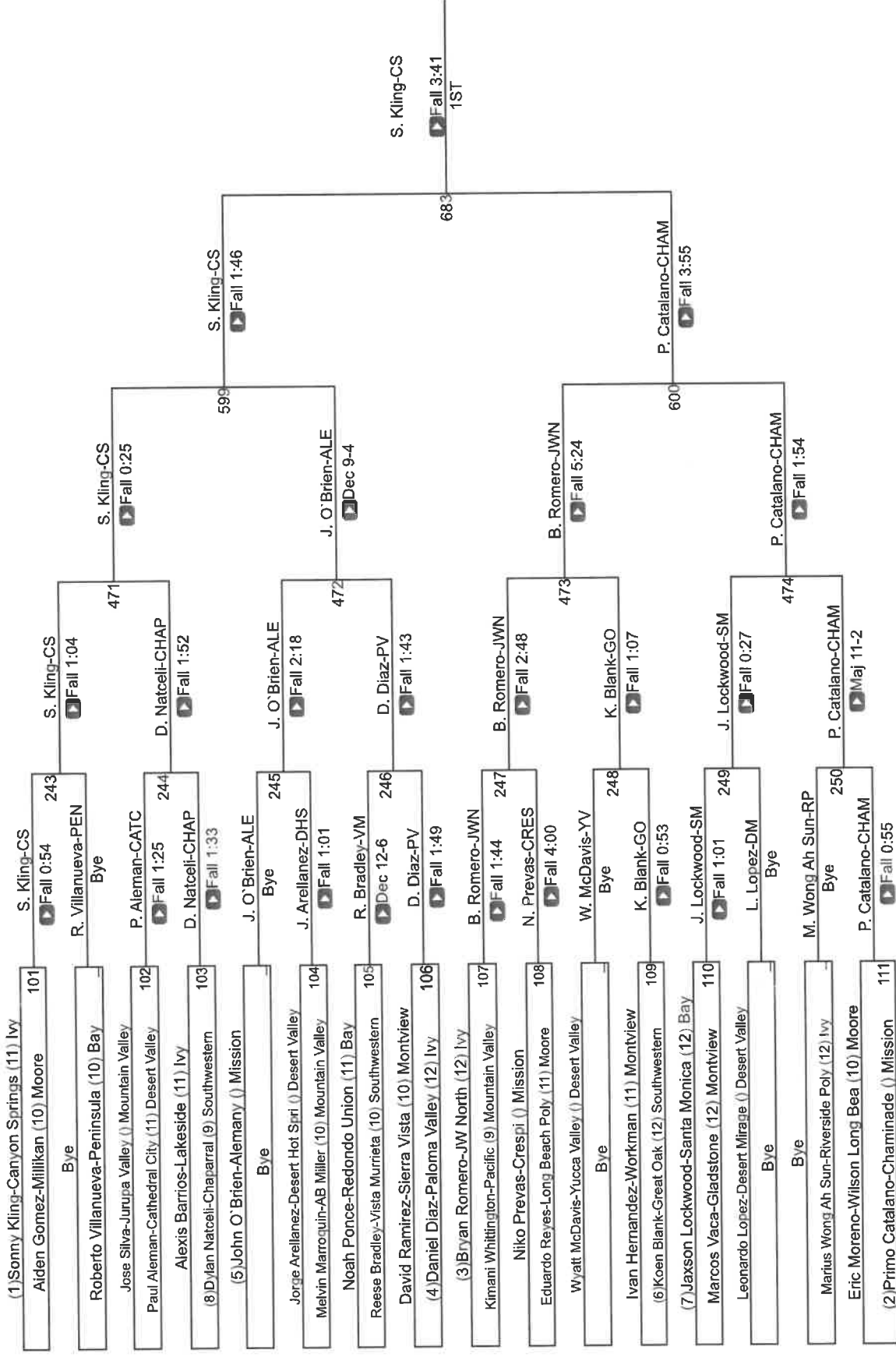

CIF Qualifier 182

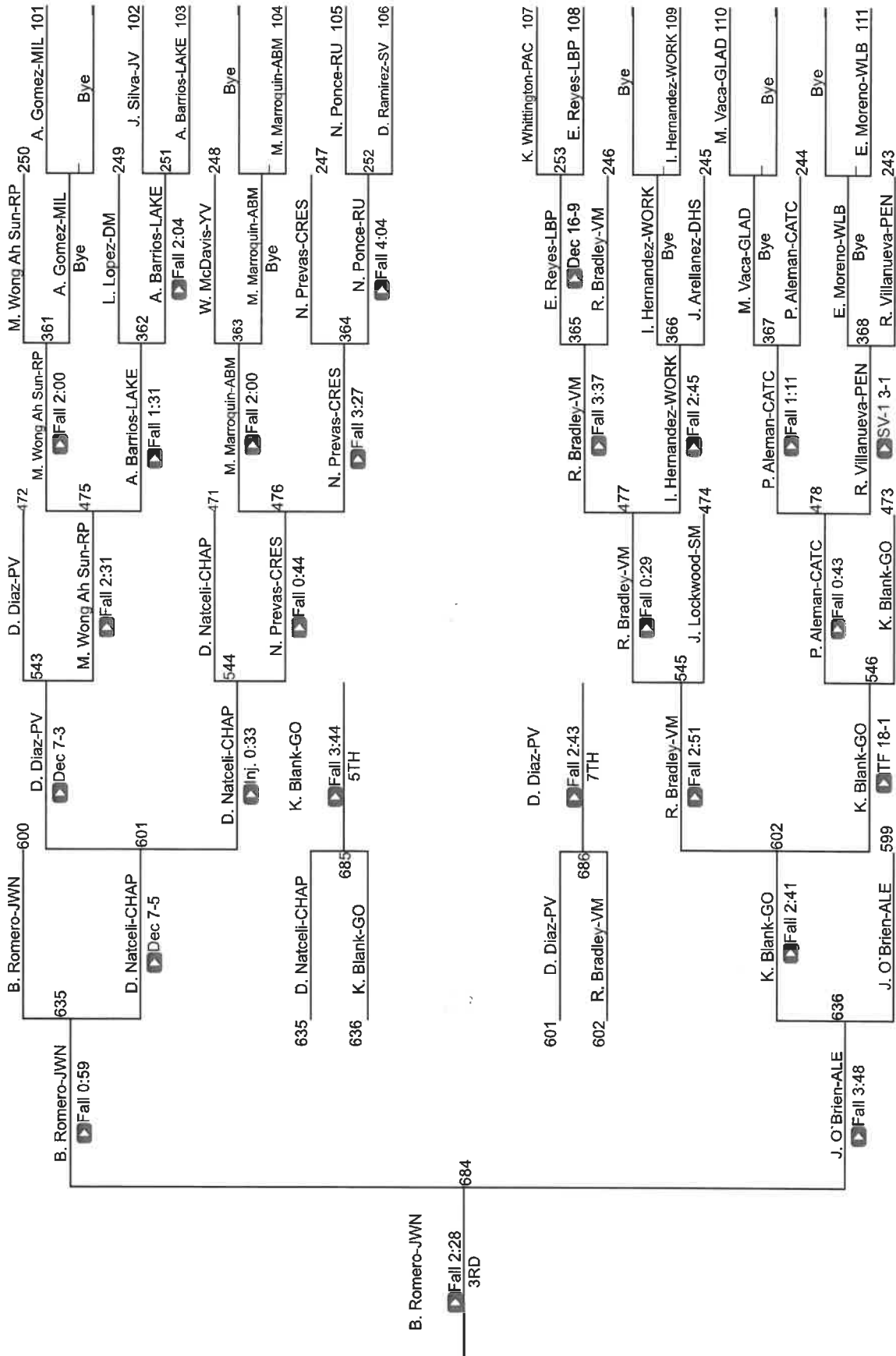

CIF SS Boys Individuals Southern Div

CIF Qualifier 195

(1) Matthew Porras-Diamond-Temecula Valley (12) Southwestern

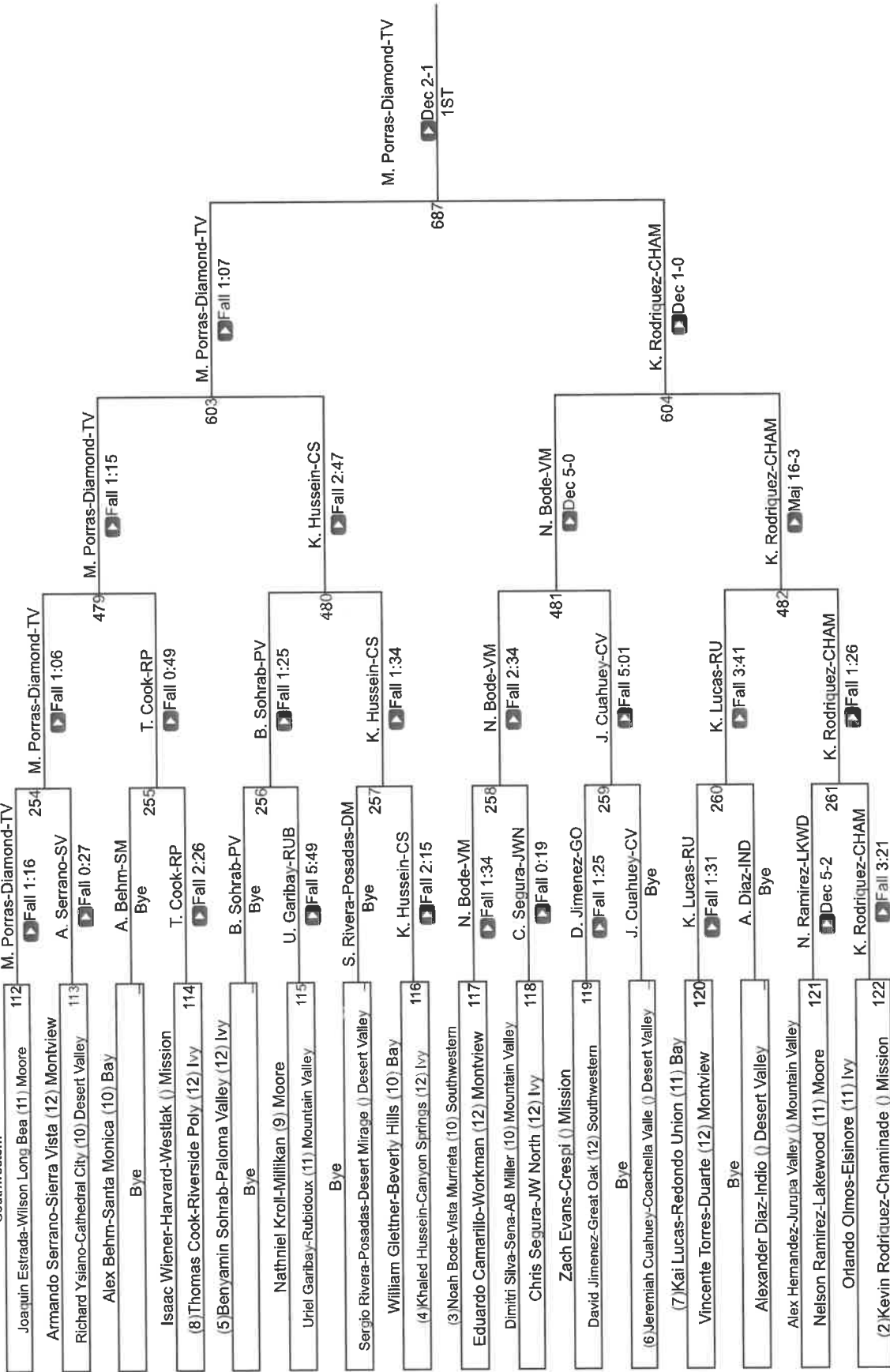

CIF SS Boys Individuals Southern Div

CIF Qualifier 220

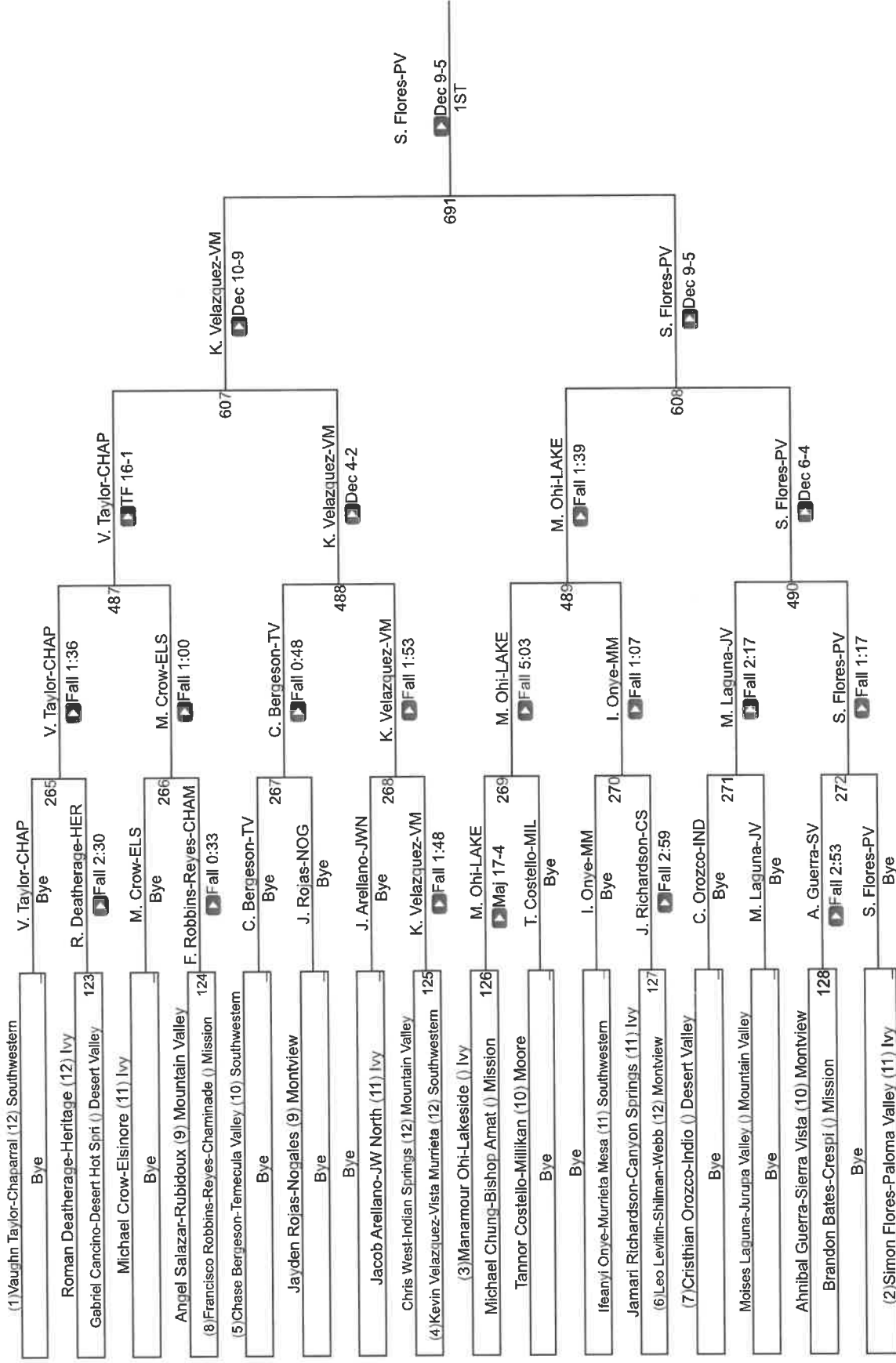

CIF Qualifier 220

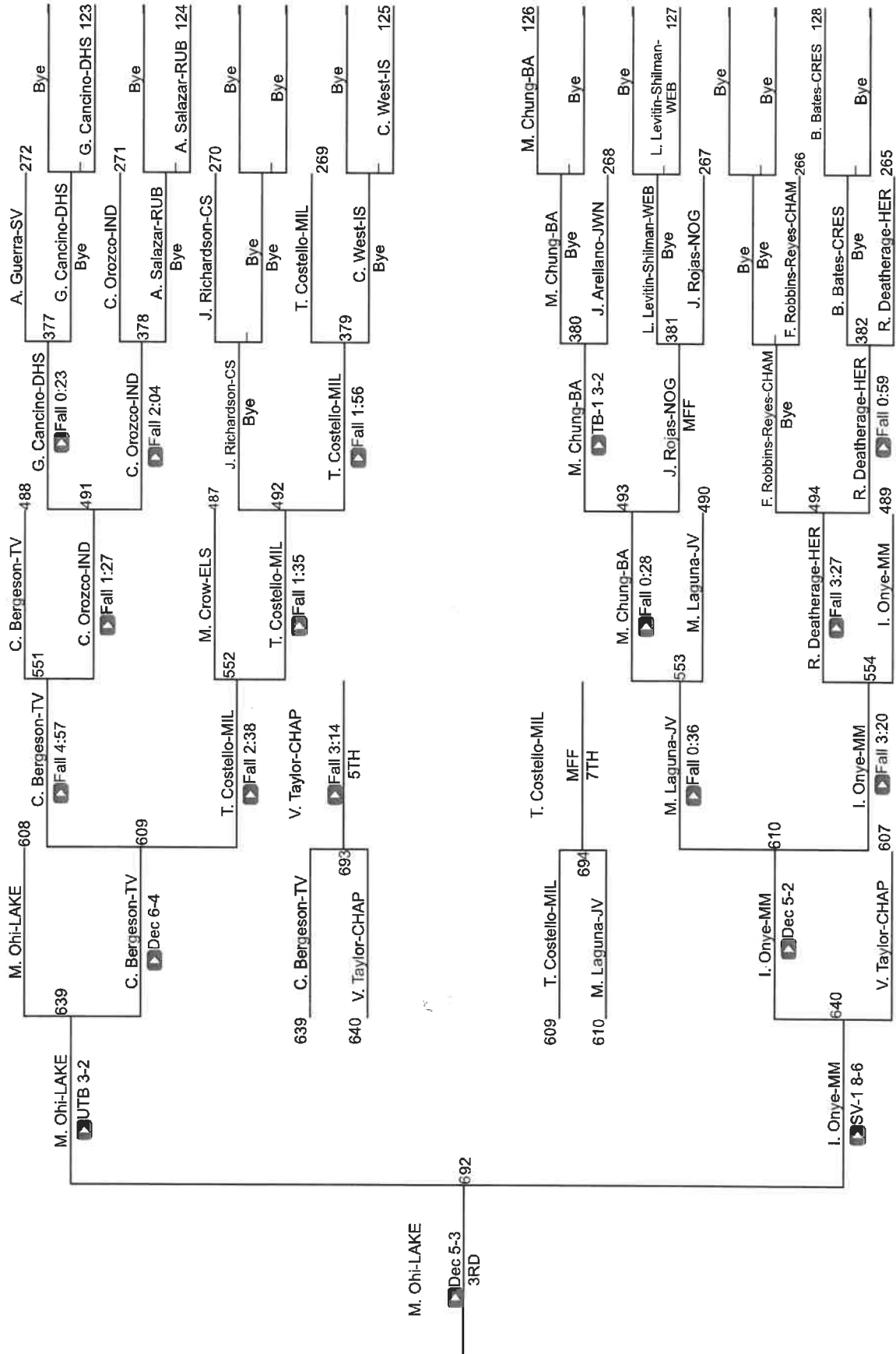

CIF SS Boys Individuals Southern Div

CIF Qualifier 285

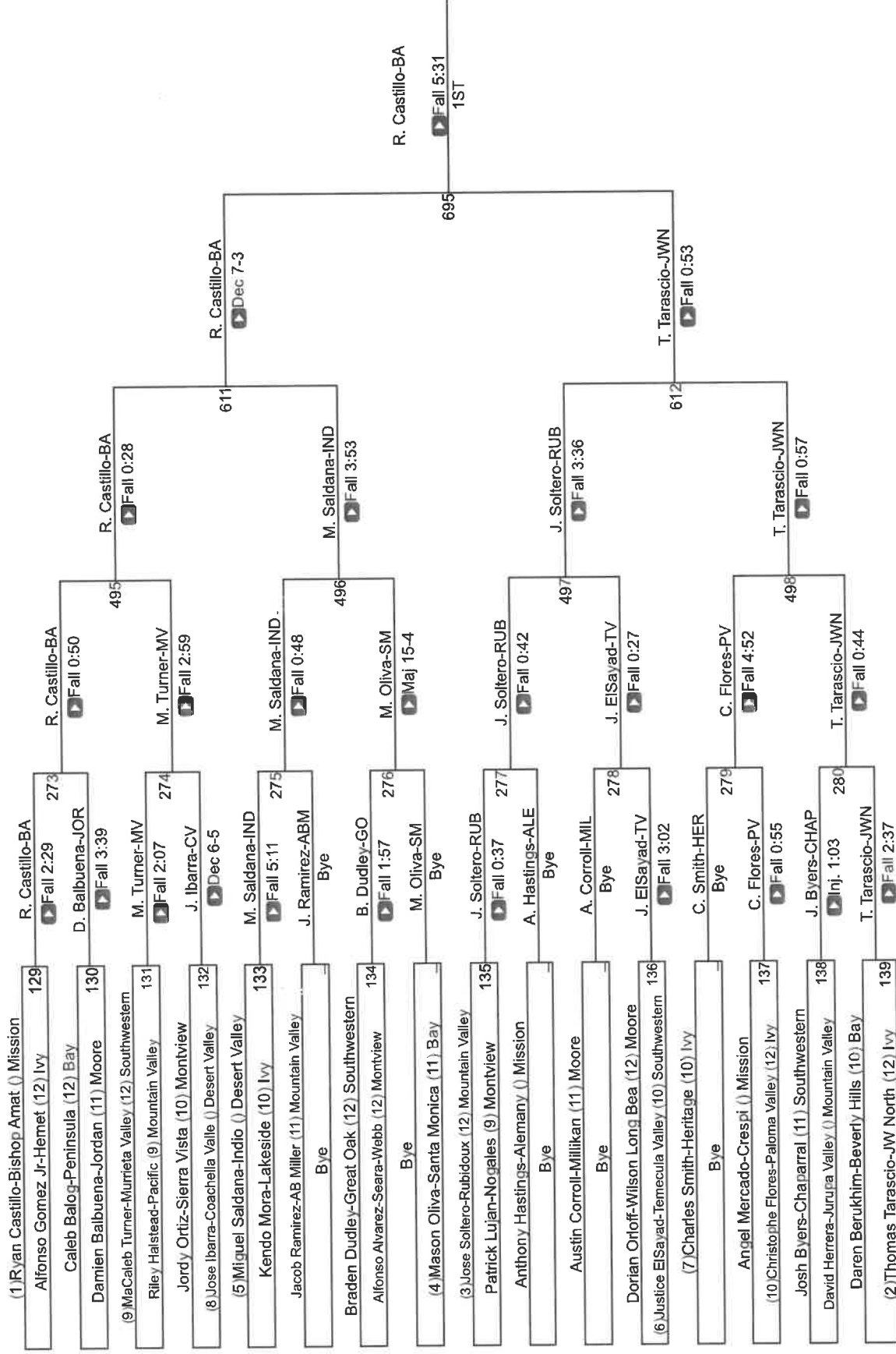

CIF Qualifier 285

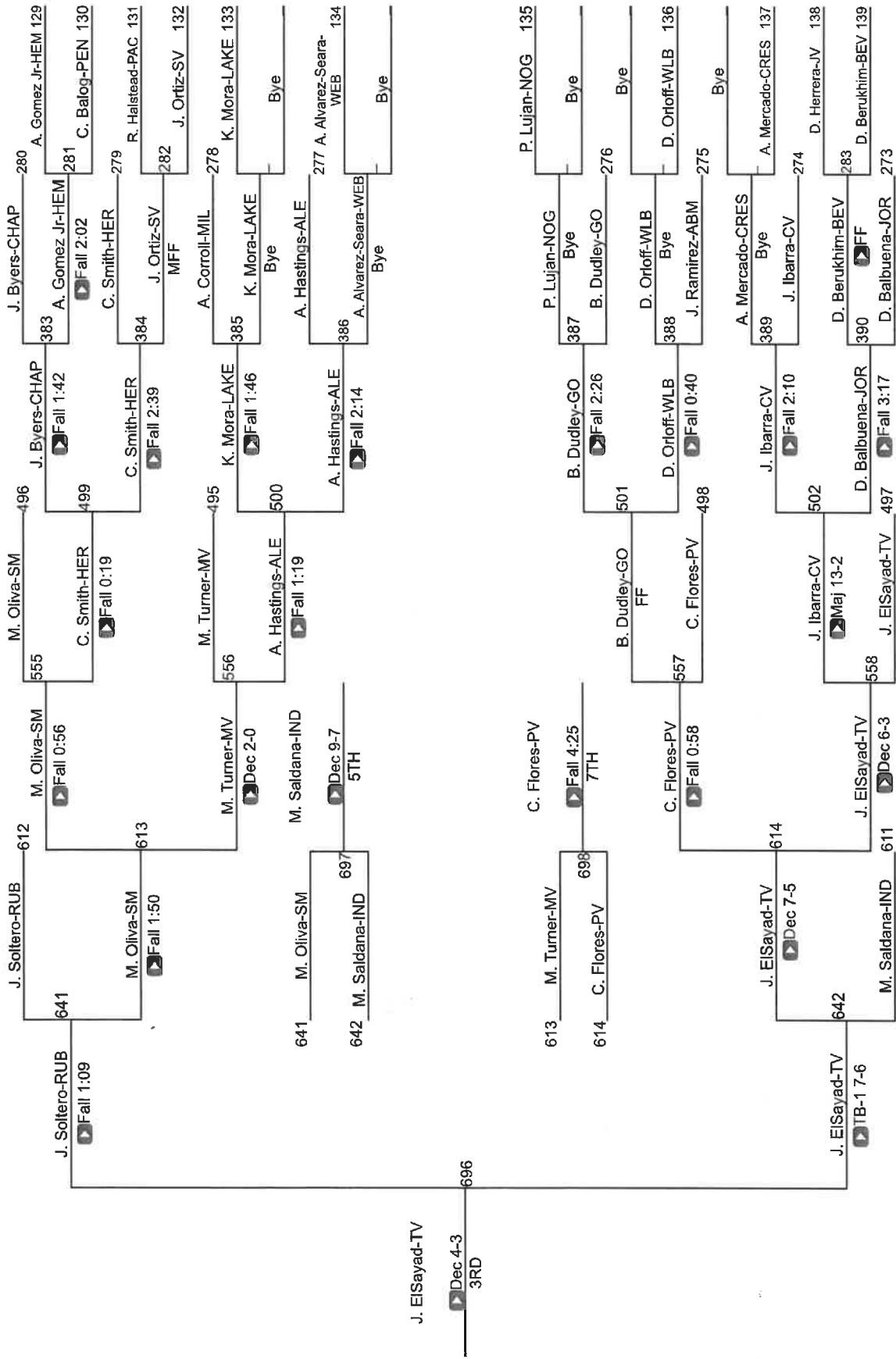

CIF Southern Section Boys

Ford Masters

Palm Springs High School

February 17, 2023



Lower Weight MVP

Grigor Cholakyan
St John Bosco
138 Pounds

Upper Weight MVP

Erik McCown
Palm Desert
170 Pounds

Placers

Blue 106 Pounds			Blue 152 Pounds			Team Score Final		
1st	Paulo Valdez	Hesperia	1st	Beau Mantanona	Palm Desert	1	St John Bosco	270.5
2nd	Marcus Tolentino	Northview	2nd	Brian Leon	Eleanor Roosevelt	2	Palm Desert	249.5
3rd	Elijah Poe	Calvary Chapel SA	3rd	Julian Jeong	Oak Hills	3	Northview	143
4th	Rocky Humphrey	Sultana	4th	Elijah Benavidez	Paloma Valley	4	Fountain Valley	139.5
5th	Isaiah Cruz	Mayfair	5th	Daniel Sterling	Temecula Valley	5	Temecula Valley	136.5
6th	Isaac Castaneda	Martin Luther King	6th	Mason Hernandez	Citrus Valley	6	Calvary Chapel SA	112.5
Blue 113 Pounds			Blue 160 Pounds			7	Chaminade	100
1st	Ronnie Ramirez	Walnut	1st	Nicco Ruiz	St John Bosco	8	Hesperia	98
2nd	Mason Carrillo	Royal	2nd	Will Cox	Yorba Linda	9	Walnut	89.5
3rd	Issac Torres	St John Bosco	3rd	Gabriel Barragan	West Valley	10	Corona Del Mar	81.5
4th	Jason Saenz	Eleanor Roosevelt	4th	Logan Alawneh	Temecula Valley	11	Lakeside	73.5
5th	Steve Corona	Vista Murrieta	5th	Nicolas Pham	Westminster	12	Chino	71.5
6th	Brandon Ryan	Murrieta Valley	6th	Lance Dunwoody	Lutheran Orange	13	Trabuco Hills	70
Blue 120 Pounds			Blue 170 Pounds			14	Eleanor Roosevelt	66
1st	Isalah Quintero	El Dorado	1st	Erik McCown	Palm Desert	15	Canyon Springs	59
2nd	Aidan Munoz	Temecula Valley	2nd	Khale McDonnell	Fountain Valley	16	Camarillo	57
3rd	Christian Garcia	Walnut	3rd	Roy Haroun	Villa Park	17	Etiwanda	56
4th	Mateo Ochoa	Martin Luther King	4th	Kameron Phillips	Temecula Valley	18	Yucaipa	54
5th	Ricardo Ponce	Redlands East Valley	5th	Beni Magyar	Irvine	19	Servite	53
6th	Demian Pryima	Newport Harbor	6th	Michael Alvarez	Mater Dei	20	Oak Hills	51
Blue 126 Pounds			Blue 182 Pounds			21	Paloma Valley	49
1st	Richard Murillo	Canyon Springs	1st	Sonny Kling	Canyon Springs	22	San Clemente	44
2nd	Justin Herrera	Chaparral	2nd	Primo Catalano	Chaminade	23	Chaparral	43
3rd	Bryce Gonzales	Norco	3rd	Michael Vassalle	Chino	24	Marina	42
4th	Gavin Laverde	Millikan	4th	Alex Munoz	Valencia	25	Serrano	40
5th	Jacob Bell	Etiwanda	5th	Logan Witten	Trabuco Hills	26	Mayfair	37
6th	Andrew Diaz	Hesperia	6th	Caleb Smith	Etiwanda	27	Norco	37
Blue 132 Pounds			Blue 195 Pounds			28	El Dorado	36
1st	Mario Sandoval	Northview	1st	Ryland Whitworth	Fountain Valley	29	Villa Park	33
2nd	Benjamin Wimberly	San Clemente	2nd	Matthew Porras-Diamond	Temecula Valley	30	Vista Murrieta	33
3rd	Slava Shahbazyan	Chaminade	3rd	Daniel Gurovich	Camarillo	31	San Marino	32.5
4th	Tigran Greyan	St John Bosco	4th	Diego Morales	Palm Desert	32	Martin Luther King	31
5th	Dylan Guillermo	Palm Desert	5th	Ramirez Kevin	Yucaipa	33	Bishop Amat	30
6th	Axel Esparza	Lakeside	6th	Ezekiel Ormsby	South Torrance	34	Yorba Linda	30
Blue 138 Pounds			Blue 220 Pounds			35	JW North	29
1st	Brock Mantanona	Palm Desert	1st	Nicholas Sahakian	St John Bosco	36	Esperanza	28
2nd	Ryder Yoshitake	San Marino	2nd	Jose Zendejas	La Quinta	37	La Quinta	28
3rd	Kenneth Rodgers	Esperanza	3rd	Anthony DeLeon	Serrano	38	Royal	28
4th	Michael Folch	Calvary Chapel SA	4th	Vaughn Taylor	Chaparral	39	Millikan	26.5
5th	Aaron Ramirez	Victor Valley	5th	Simon Flores	Paloma Valley	40	Centennial Corona	24
6th	Jacob Arvizo	Murrieta Mesa	6th	Elijah Tehe	Montclair	41	Valencia Placentia	23
Blue 145 Pounds			Blue 285 Pounds			42	West Valley	23
1st	Andrew Barbosa	Palm Desert	1st	Daniel Herrera	Palm Desert	43	Bonita	22
2nd	Spencer Von Savoye	Chaminade	2nd	Anthony Garcia	Rio Mesa	44	Sultana	22
3rd	Tristan Fernandez	Bonita	3rd	Thomas Tarascio	JW North	45	Riverside Poly	21.5
4th	Joshua Valdez	Servite	4th	Justice ElSayad	Temecula Valley	46	Victor Valley	21
5th	Isaac Rea	Lakeside	5th	Hector Jimenez	Charter Oak	47	Irvine	20
6th	Nathan Marquez	Downey	6th	Nathan Boyce	St John Bosco	48	Rio Mesa	20
						49	Valencia	19
						50	JSerra	18
						51	Los Altos	18
						52	Segerstrom	18
						53	Charter Oak	17
						54	Hillcrest	17
						55	Norwalk	17
						56	Redlands East Valley	17
						57	Citrus Valley	16
						58	Glendora	16
						59	Lutheran Orange	15
						60	Newport Harbor	13
						61	Cypress	12
						62	Indio	12
						63	Alta Loma	10
						64	Moorpark	10
						65	Redondo Union	10
						66	Santa Monica	9
						67	Sonora	9
						68	Westminster	9

CIF Southern Section Boys

Ford Masters

Palm Springs High School

February 17, 2023



Lower Weight MVP

Grigor Cholakyan
St John Bosco
138 Pounds

Upper Weight MVP

Erik McCown
Palm Desert
170 Pounds

Placers

Gold 106 Pounds			Gold 152 Pounds			Team Score Final		
1st	Sean Willcox	St John Bosco	1st	Jacob Salcedo	Northview	1	St John Bosco	270.5
2nd	Erik Ramirez	Palm Desert	2nd	Kristofer Arrey	Riverside Poly	2	Palm Desert	249.5
3rd	Camilo Ramirez	Walnut	3rd	Antonio Aramburu	Corona Del Mar	3	Northview	143
4th	Jonathan Madera	Chino	4th	Dominic Morales	San Clemente	4	Fountain Valley	139.5
5th	Yousef Jubrail	Chaminade	5th	Andrew Asbury	Trabuco Hills	5	Temecula Valley	136.5
6th	Hunter Jauregui	Fountain Valley	6th	Yazir Tellez	St John Bosco	6	Calvary Chapel SA	112.5
Gold 113 Pounds			Gold 160 Pounds			7	Chaminade	100
1st	Anthony Lucio	Fountain Valley	1st	David Alonso	Palm Desert	8	Hesperia	98
2nd	Aaron Silva	Calvary Chapel SA	2nd	Kris Castro	Chaminade	9	Walnut	89.5
3rd	Adrian Jimenez	Marina	3rd	Julius Soria	Chino	10	Corona Del Mar	81.5
4th	Emiliano Hernandez	Hesperia	4th	Javier Montes	Eleanor Roosevelt	11	Lakeside	73.5
5th	Syruss Flores	Paloma Valley	5th	Zion Hernandez	Corona Del Mar	12	Chino	71.5
6th	Ryland Madrid	Centennial Corona	6th	Noah Zuniga	Trabuco Hills	13	Trabuco Hills	70
Gold 120 Pounds			Gold 170 Pounds			14	Eleanor Roosevelt	66
1st	Nathan Carrillo	St John Bosco	1st	Max McWilliams	Calvary Chapel SA	15	Canyon Springs	59
2nd	Jaxson Taber	Palm Desert	2nd	Nathan Cruz	Northview	16	Camarillo	57
3rd	Hector Hernandez	Hesperia	3rd	Julian Barajas	St John Bosco	17	Etiwanda	56
4th	Luis Solis	Los Altos	4th	Blake Chaffee	Serrano	18	Yucaipa	54
5th	Logan Andrews	Moorpark	5th	Marquize Brown	Glendora	19	Servite	53
6th	Bach Le	Edison	6th	Joseph Dervartanian	Lutheran Orange	20	Oak Hills	51
Gold 126 Pounds			Gold 182 Pounds			21	Paloma Valley	49
1st	Ryan Lobato	Lakeside	1st	Timothy McDonnell	Fountain Valley	22	San Clemente	44
2nd	Haden Hernandez	Marina	2nd	Diego Costa	Yucaipa	23	Chaparral	43
3rd	Joshua Requena	Camarillo	3rd	Sonny Acuna	Northview	24	Marina	42
4th	Zaydrein Hernandez	St John Bosco	4th	Talha Bektas	Calvary Chapel SA	25	Serrano	40
5th	Maddox Herrera	Esperanza	5th	Shea Gabriel	Oak Hills	26	Mayfair	37
6th	Nathan Cauwel	Chino	6th	John O'Brien	Alemanly	27	Norco	37
Gold 132 Pounds			Gold 195 Pounds			28	El Dorado	36
1st	Malikhi Espiritu	Temecula Valley	1st	Eugenio Franco	Corona Del Mar	29	Villa Park	33
2nd	Elijah Flores	Walnut	2nd	Mark Ayala	St John Bosco	30	Vista Murrieta	33
3rd	Emilio Medina	Camarillo	3rd	Kayden Cartee	Mayfair	31	San Marino	32.5
4th	Loscar Riestra	Corona Del Mar	4th	Javier Gonzalez	Norco	32	Martin Luther King	31
5th	Evan Roy	Hesperia	5th	Noah Bode	Vista Murrieta	33	Bishop Amat	30
6th	Gabe Balingit	Etiwanda	6th	Kevin Rodriguez	Chaminade	34	Yorba Linda	30
Gold 138 Pounds			Gold 220 Pounds			35	JW North	29
1st	Grigor Cholakyan	St John Bosco	1st	Henry Sturm	Trabuco Hills	36	Esperanza	28
2nd	Justin Wells	Lakeside	2nd	Charles King	Oak Hills	37	La Quinta	28
3rd	Hercules Windrath	Fountain Valley	3rd	Luke Webb	JSerra	38	Royal	28
4th	Matthias Valdez	Hesperia	4th	Gabriel Chavez	Hillcrest	39	Mililkan	26.5
5th	Viviano Gutierrez	Northview	5th	Kevin Cardenas	Villa Park	40	Centennial Corona	24
6th	Paul Knapp	Martin Luther King	6th	Kevin Velazquez	Vista Murrieta	41	Valencia Placentia	23
Gold 145 Pounds			Gold 285 Pounds			42	West Valley	23
1st	Joseph Antonio	St John Bosco	1st	Ryan Castillo	Bishop Amat	43	Bonita	22
2nd	Evan Manzo	Etiwanda	2nd	Dib Sawaya	Valencia Placentia	44	Sultana	22
3rd	Steve Caday	Calvary Chapel SA	3rd	Dylan Avila	Seegerstrom	45	Riverside Poly	21.5
4th	Sean Otero	Norwalk	4th	Oskar Madrigal	Servite	46	Victor Valley	21
5th	Mikel David Uyemura	San Marino	5th	Miguel Saldana	Indio	47	Irvine	20
6th	Niko Valenzuela	Redondo Union	6th	Emiliano Gonzalez	Sonora	48	Rio Mesa	20
						49	Valencia	19
						50	JSerra	18
						51	Los Altos	18
						52	Seegerstrom	18
						53	Charter Oak	17
						54	Hillcrest	17
						55	Norwalk	17
						56	Redlands East Valley	17
						57	Citrus Valley	16
						58	Glendora	16
						59	Lutheran Orange	15
						60	Newport Harbor	13
						61	Cypress	12
						62	Indio	12
						63	Alta Loma	10
						64	Moorpark	10
						65	Redondo Union	10
						66	Santa Monica	9
						67	Sonora	9
						68	Westminster	9

CIF SS Boys Ford Masters Wrestling Meet

Blue 126

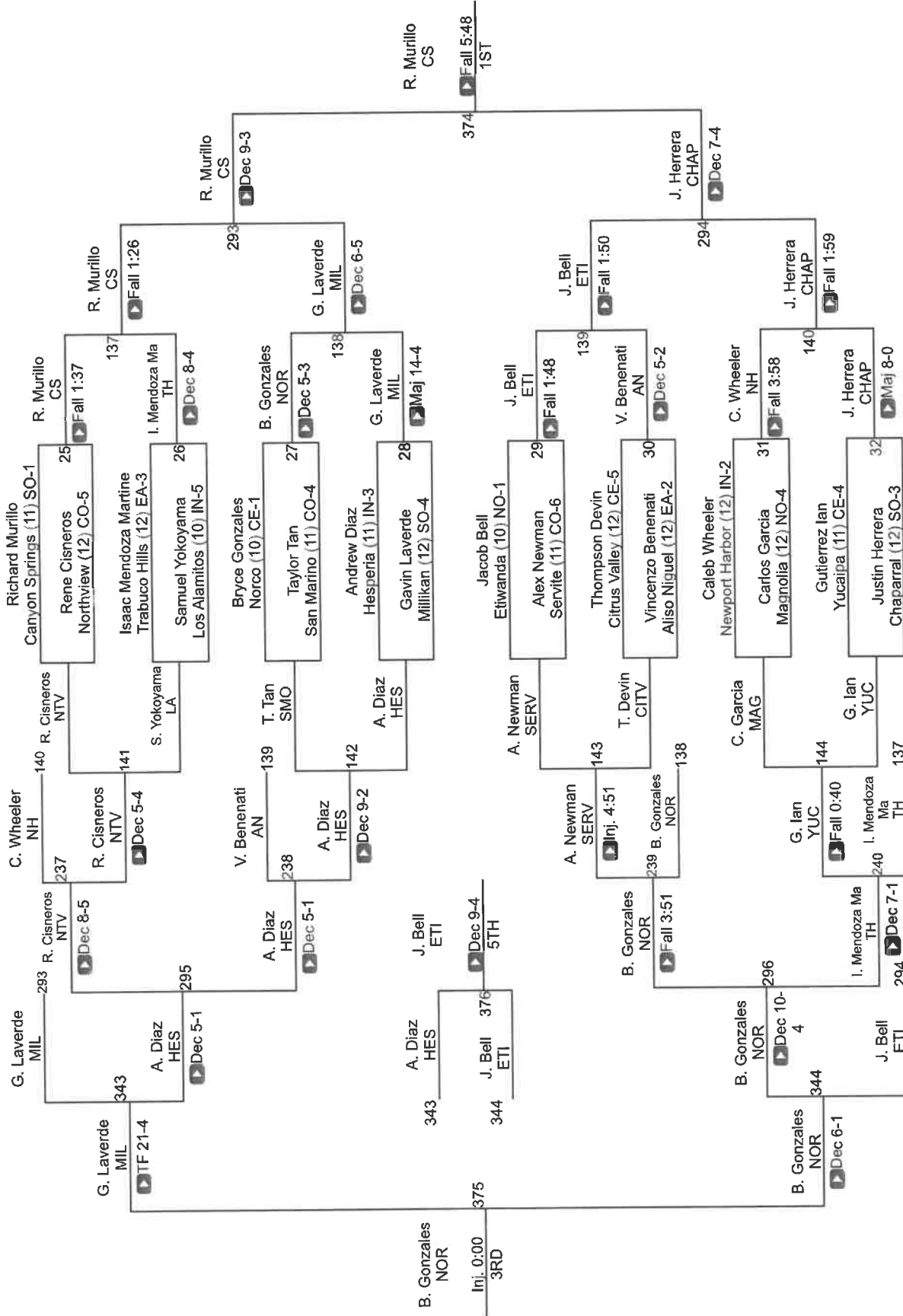

CIFSS Boys Ford Masters Wrestling Meet

Blue 285

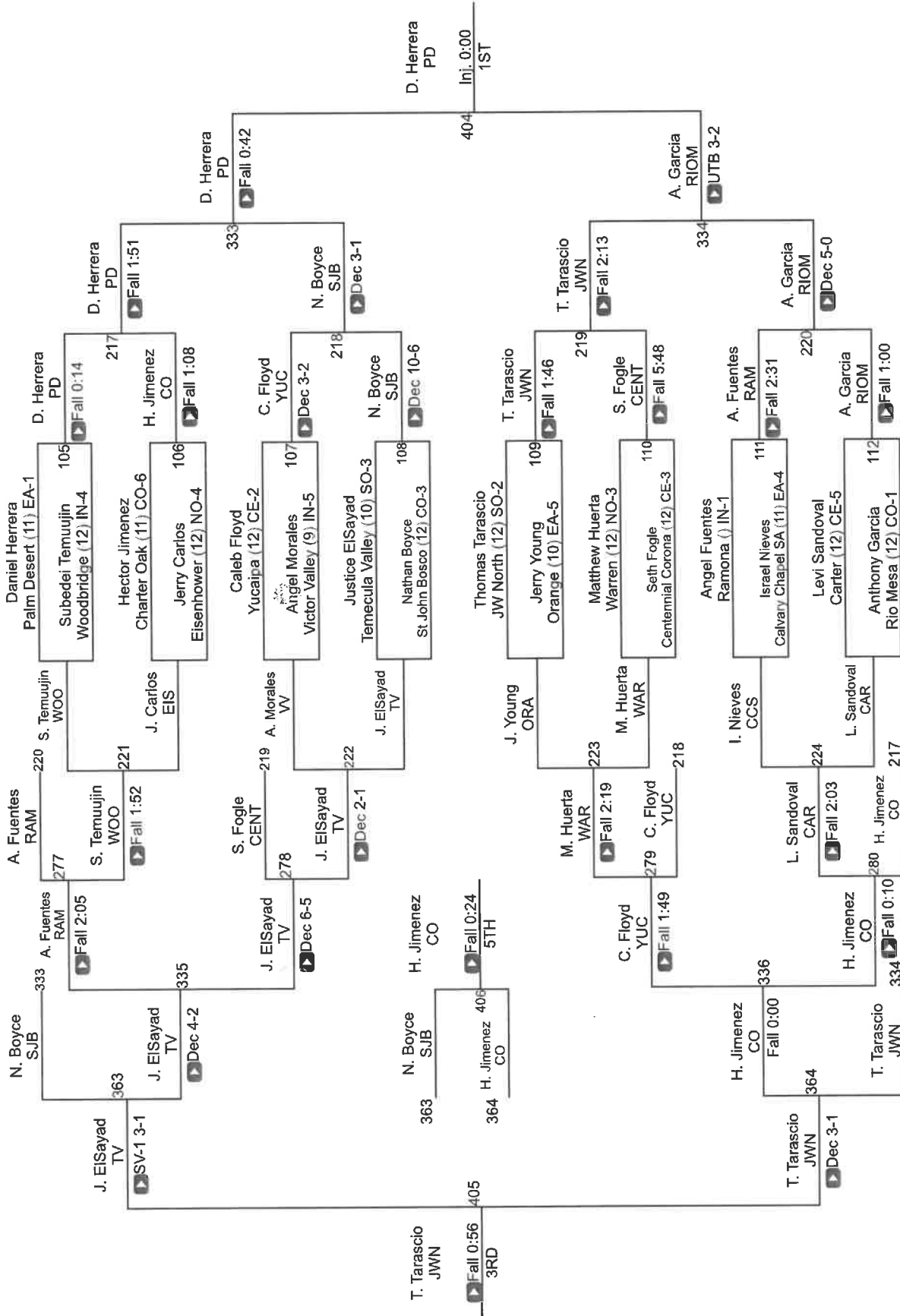

CIF SS Boys Ford Masters Wrestling Meet

Gold 106

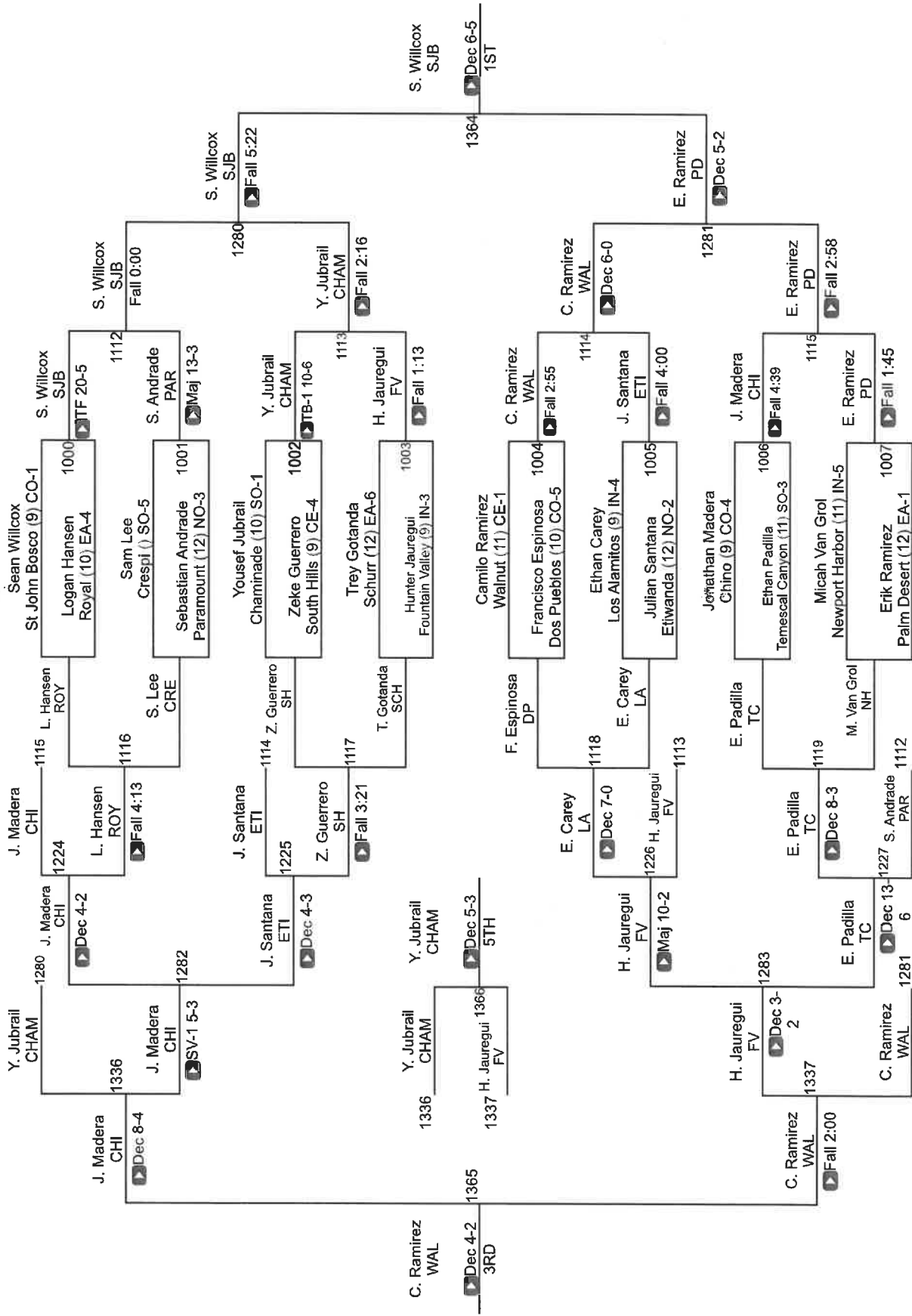

CIFSS Boys Ford Masters Wrestling Meet

Gold 113

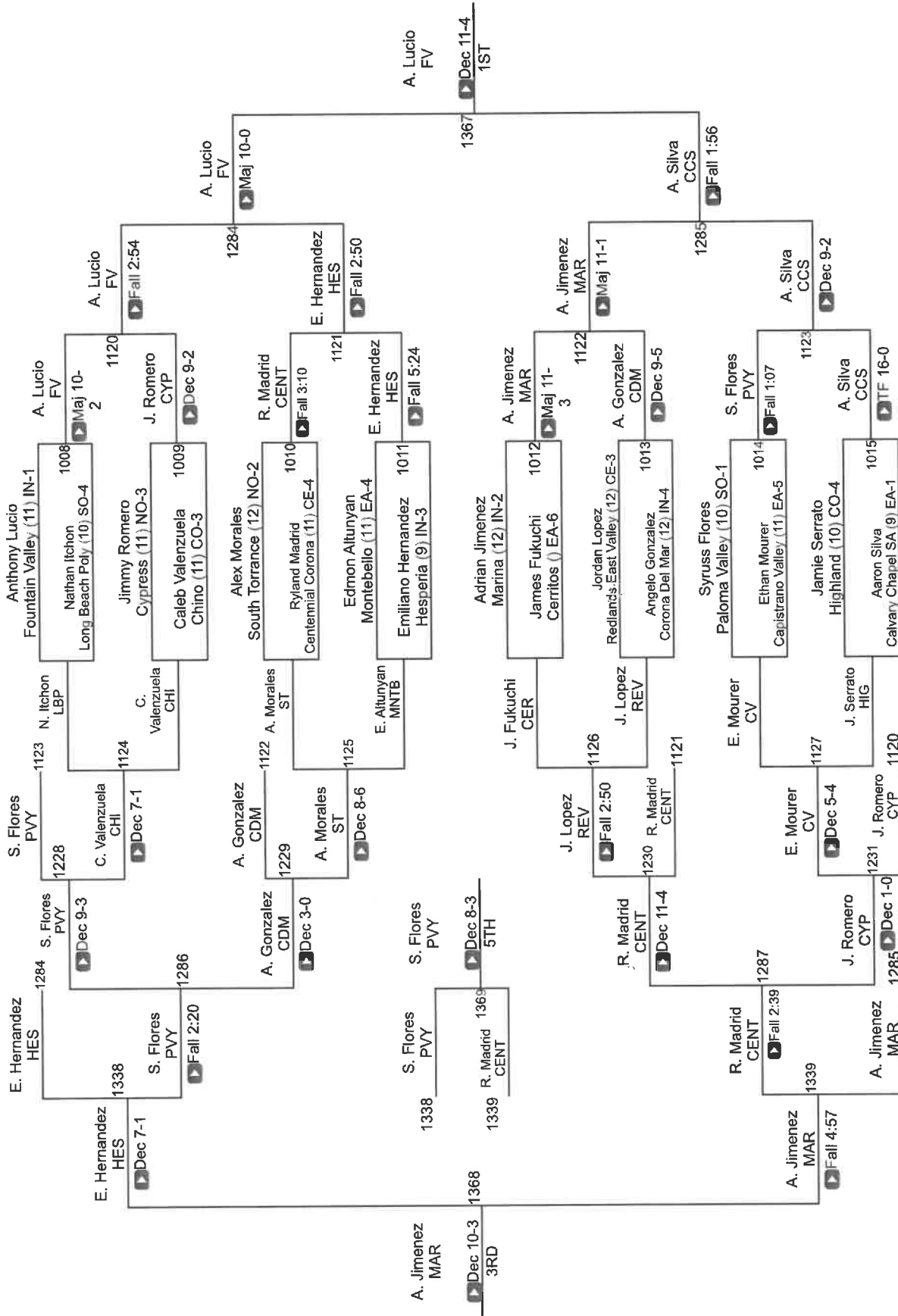

CIF SS Boys Ford Masters Wrestling Meet

Gold 126

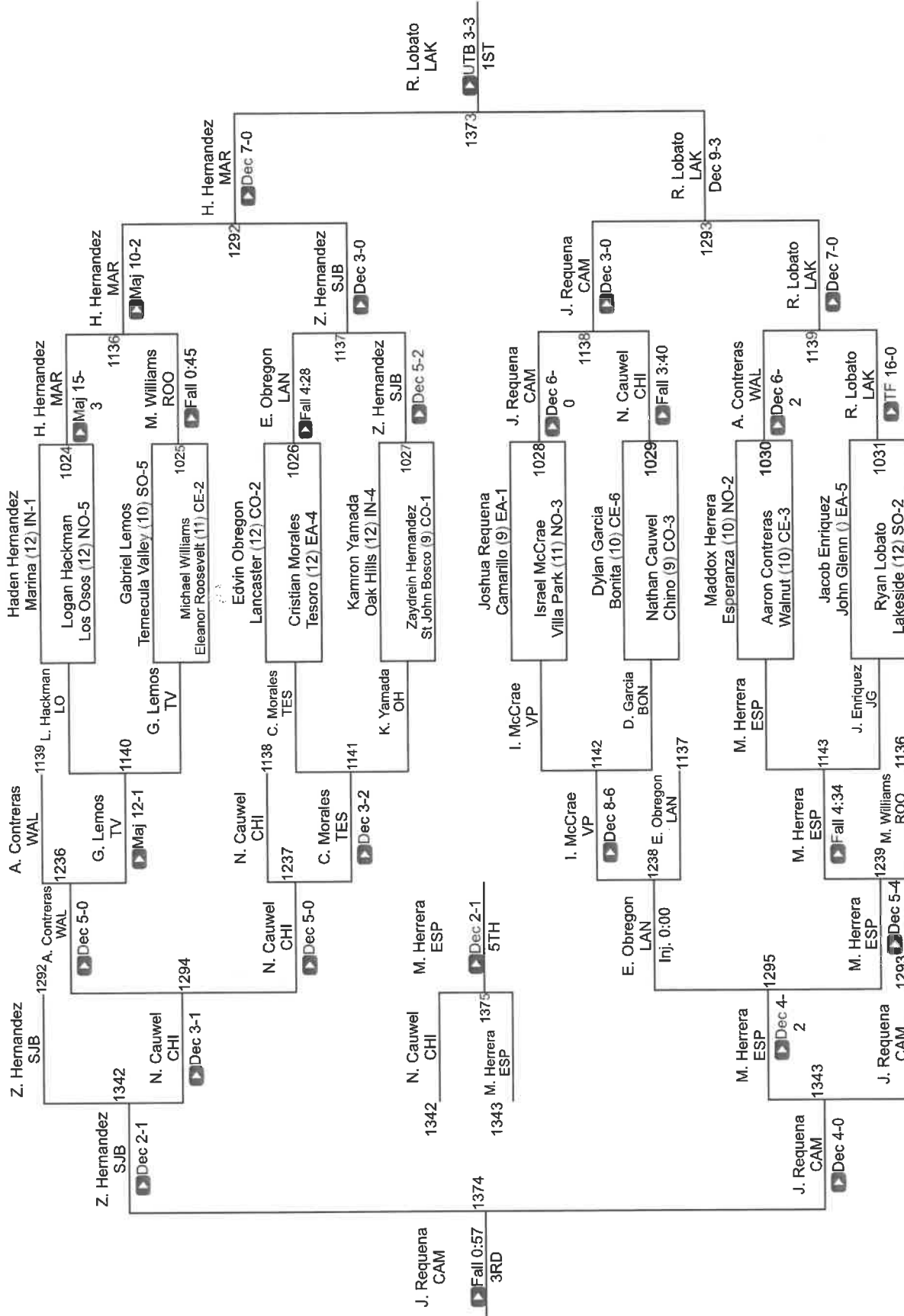

CIF SS Boys Ford Masters Wrestling Meet

Gold 132

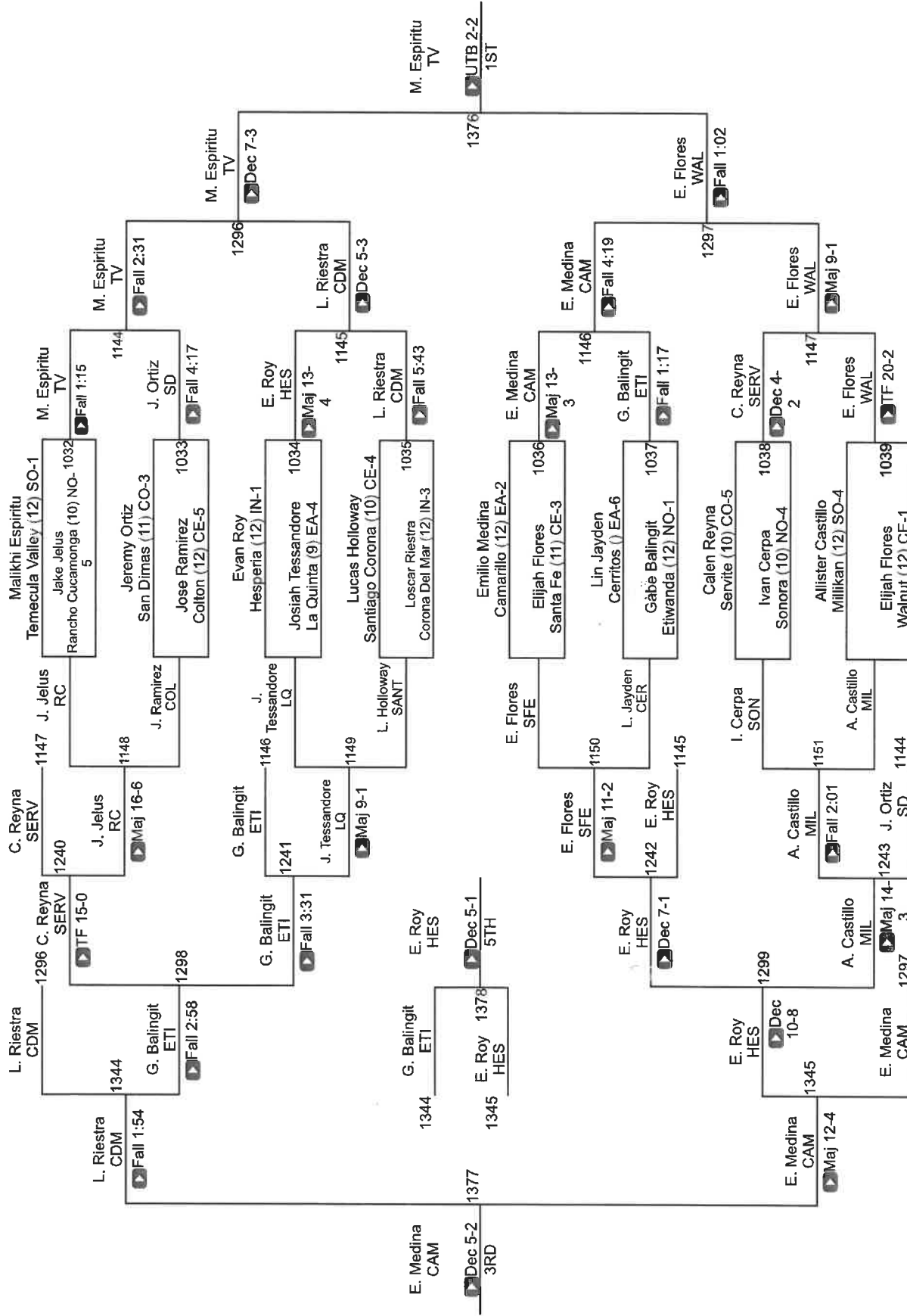

CIF SS Boys Ford Masters Wrestling Meet

Gold 152

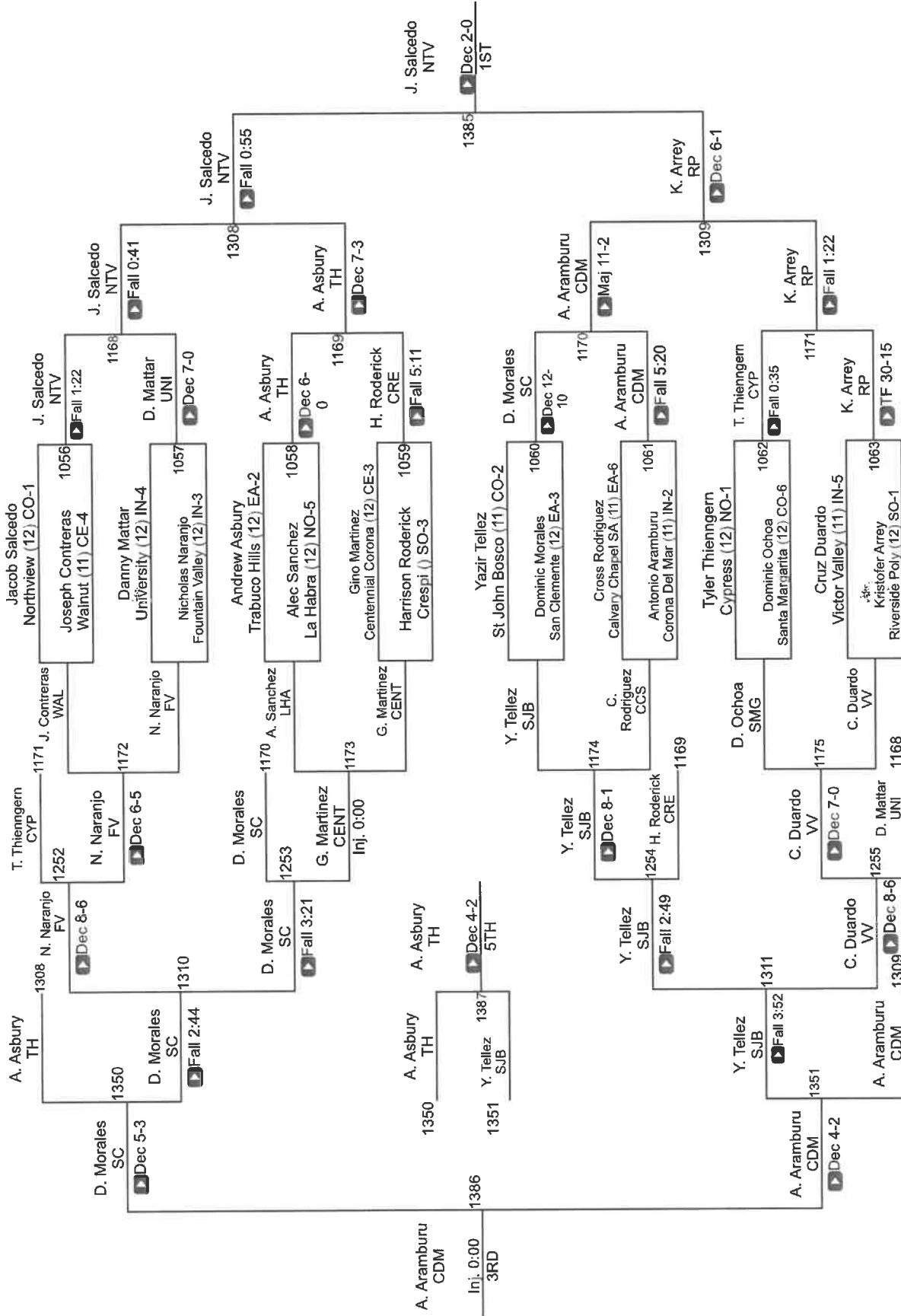

CIFSS Boys Ford Masters Wrestling Meet

Gold 160

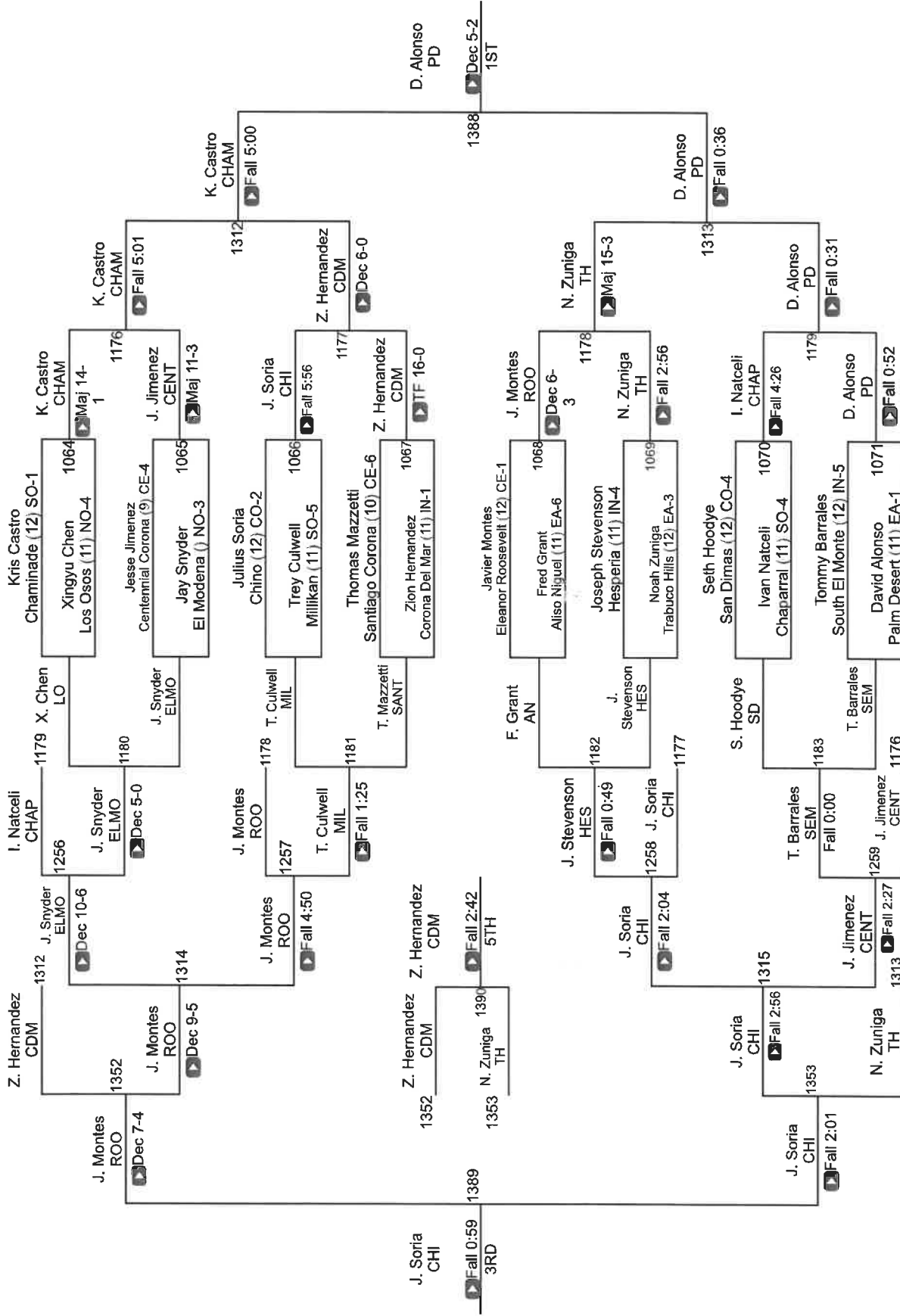

CIF SS Boys Ford Masters Wrestling Meet

Gold 170

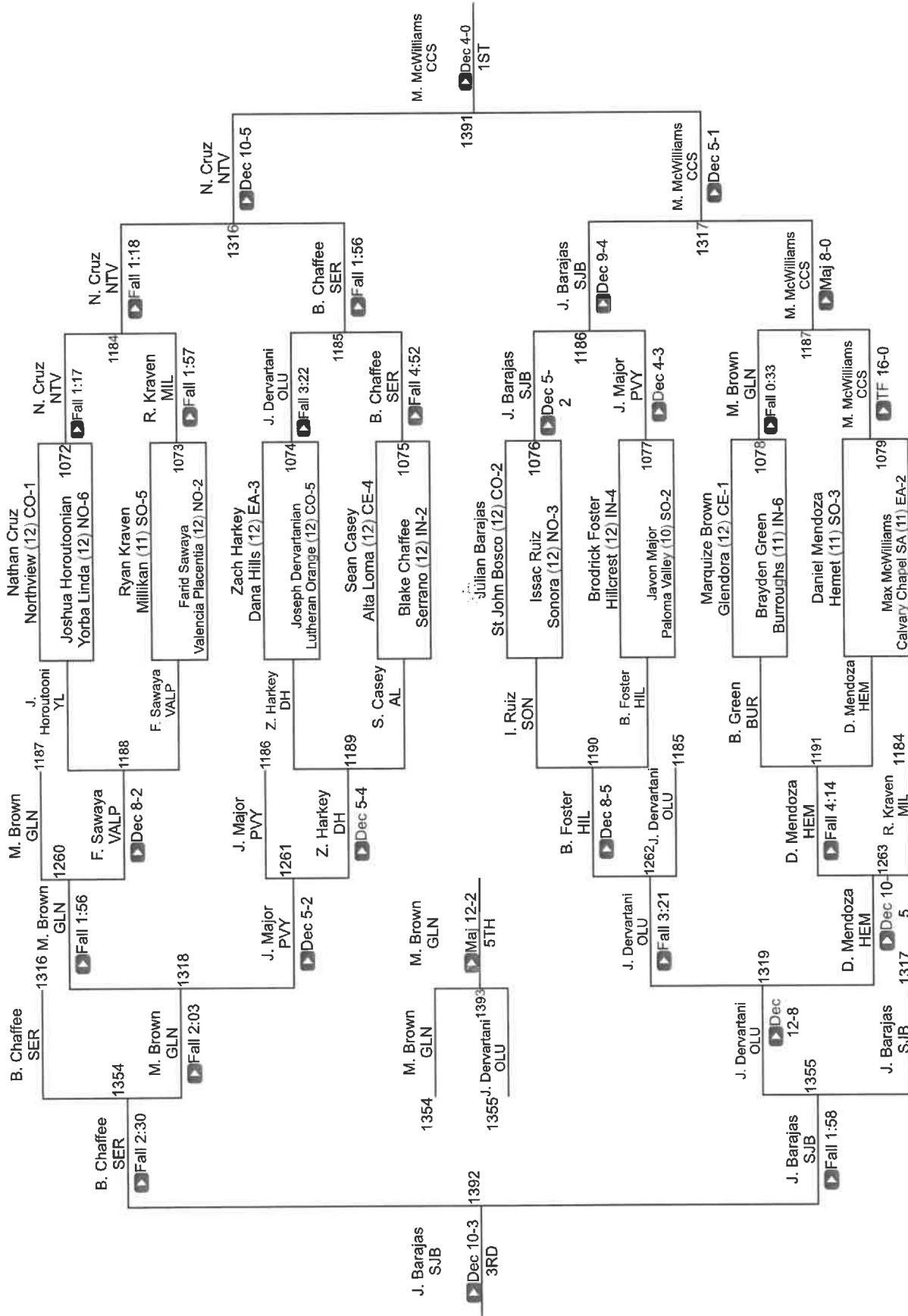

CIFSS Boys Ford Masters Wrestling Meet

Gold 182

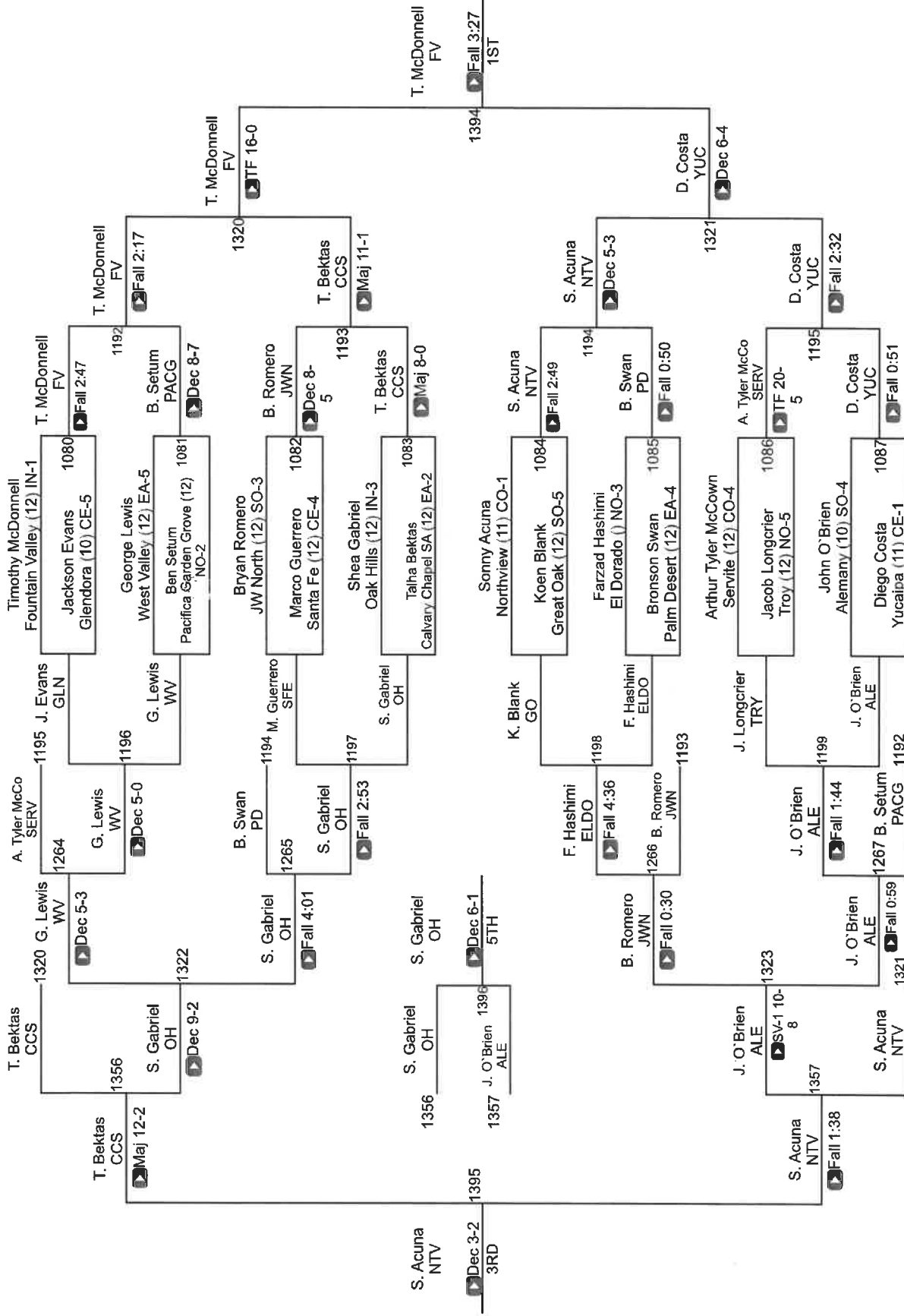

CIFSS Boys Ford Masters Wrestling Meet

Gold 220

