

# CIF SS Boys Individuals-Central Division

## Fountain Valley High School

February 11-12, 2022



### Lower Weight Outstanding Wrestler

Isaiah Quintero  
El Dorado HS (Placentia)  
106 Pounds

### Upper Weight Outstanding Wrestler

Timothy McDonnell  
Fountain Valley HS  
182 Pounds

### Placers

106 Pounds			152 Pounds			Team Score Final		
1st	Isaiah Quintero	El Dorado HS (Placentia)	1st	Hercules Windrath	Fountain Valley	1	Northview	251
2nd	Aidan Thome	Bishop Amat	2nd	Arvin Khosravy	Chaminade College Prep Sch	2	Fountain Valley	231
3rd	Marcus Tolentino	Northview	3rd	Julius Soria	Chino	3	Chaminade College Prep	193
4th	Adrian Jimenez	Marina	4th	Ace Garcia	Yorba Linda	4	Esperanza	172
5th	Demian Pryima	Newport Harbor	5th	Sonny Acuna Zepeda	Northview	5	Bishop Amat	153
6th	Sergio Quezada	Montclair	6th	Zion Hernandez	Corona Del Mar	6	Corona Del Mar	148.5
7th	Dylan Barnes	Chaminade College Prep Sch	7th	Mathew Holiday	Esperanza	7	Chino	133
8th	Caleb Valenzuela	Chino	8th	James Orcha	Thousand Oaks	8	Villa Park	132.5
113 Pounds			160 Pounds			9	Yorba Linda	113.5
1st	Eryn Ewing	Canyon (Anheim)	1st	Arian Khosravy	Chaminade College Prep Sch	10	Sonora (La Habra)	96
2nd	Maddox Herrera	Esperanza	2nd	Nathan Cruz	Northview	11	Marina	86.5
3rd	Jameer McCrae	Villa Park	3rd	Mateo Jaramillo	Yorba Linda	12	Fullerton	79
4th	Nicholas Arellano	Northview	4th	Roy Haroun	Villa Park	13	Newport Harbor	77.5
5th	Kai Villaseñor	Newport Harbor	5th	Seth Hoodye	San Dimas	14	El Dorado HS (Placentia)	77
6th	Robert Herrera	Sonora (La Habra)	6th	Adin Gallegos	Corona Del Mar	15	Brea Olinda	66.5
7th	Angelo Gonzalez	Corona Del Mar	7th	Alejandro Nieto	El Dorado HS (Placentia)	16	Santa Fe	65.5
8th	Gavin Alfaro	Bishop Amat	8th	Caden Terry	Newbury Park	17	El Modena	56.5
120 Pounds			170 Pounds			18	Los Alamitos	55
1st	Adrian Limon	Northview	1st	Carlos Centeno	Esperanza	19	Foothill (Santa Ana)	52.5
2nd	Romero Sanchez	Esperanza	2nd	Jack Simons	El Modena	20	San Dimas	52
3rd	Haden Hernandez	Marina	3rd	Kristopher Castro	Chaminade College Prep Sch	21	Canyon (Anheim)	43
4th	Alan Smith	Thousand Oaks	4th	Khale McDonnell	Fountain Valley	21	La Habra	43
5th	Rene Cisneros	Baldwin Park High School	5th	Lewis Madrigal	Northview	21	Westlake	43
6th	Alexander Membreno	Bishop Amat	6th	Michael Vassalle	Chino	24	Crespi Carmelite	42.5
7th	Jason Herrera	Sonora (La Habra)	7th	John O'Brien	Bishop Alemany	25	Newbury Park	33
8th	Bach Le	Edison	8th	Rafael Garcia	Villa Park	26	Montclair	30
126 Pounds			182 Pounds			27	Brea Olinda	29
1st	Zeth Romney	Chaminade College Prep Sch	1st	Timothy McDonnell	Fountain Valley	27	Calabasas	29
2nd	Mario Sandoval	Northview	2nd	Christopher Sandoval	Villa Park	29	Laguna Beach	26
3rd	Travis Ewing	Esperanza	3rd	Luke Ewell	Los Alamitos	30	Covina	24
4th	Peter Mitchell	Foothill (Santa Ana)	4th	Jeremy Kanter	Laguna Beach	30	Ontario High School	24
5th	Giovanni Sabatasso	Newport Harbor	5th	Primo Catalano	Chaminade College Prep Sch	32	Sunny Hills	23
6th	John Strapp	Corona Del Mar	6th	Jaremi Juarez	West Covina	33	Bishop Alemany	22.5
7th	Elijah Flores	Santa Fe	7th	Isaac Ruiz	Sonora (La Habra)	34	La Serna	20.5
8th	Diego Alfaro	Bishop Amat	8th	Joel Carvajal	Yorba Linda	35	Baldwin Park High School	19
132 Pounds			195 Pounds			35	West Covina	19
1st	Sean Solis	Fountain Valley	1st	Ryland Whitworth	Fountain Valley	37	Harvard Westlake	18
2nd	Julian Leon	Northview	2nd	Eugenio Franco	Corona Del Mar	38	El Rancho	15
3rd	Jordan Mallo	Chino	3rd	Devon Jones	Bishop Amat	39	Edison	12
4th	Gianluca Munoz	Bishop Amat	4th	Austin Hulsizer	Fullerton	40	Charter Oak	11
5th	Viviano Gutierrez	Sonora (La Habra)	5th	Kevin Rodriguez	Chaminade College Prep Sch	40	Troy	11
6th	Loscar Riestra	Corona Del Mar	6th	Micah Kokin	Calabasas	42	Chaffey	8
7th	Maurizio Andrade-Igara	Esperanza	7th	Julian Bilezikjian	La Serna	42	Don Antonio Lugo	8
8th	Cruz Chavez	Villa Park	8th	Anthony Row	Yorba Linda	44	Huntington Beach	7
138 Pounds			220 Pounds			45	Agoura	6
1st	Noah Elliott	Chaminade College Prep Sch	1st	Nathan Diaz-Alvarez	Fullerton	46	Diamond Ranch	5
2nd	Kade Ayres	Fountain Valley	2nd	Leroy Garibay	Bishop Amat	47	Whittier	4
3rd	Kenneth Rodgers	Esperanza	3rd	Ryan Escamilla	Marina	48	Buena Park	0
4th	Luke Villaluz	Corona Del Mar	4th	Kevin Cardenas	Villa Park	48	California (Whittier)	0
5th	Jacob Leon	Northview	5th	Gian-Carlo Ortega	Crespi Carmelite	48	Loara	0
6th	Spencer Parry	Yorba Linda	6th	Samuel Olson	Foothill (Santa Ana)	48	Santiago (Garden Grove)	0
7th	Landon Tofaneli	Westlake	7th	Anthony Leon	Corona Del Mar			
8th	JOSEPH CASTILLO	Santa Fe	8th	Fernando Toscano	Santa Fe			
145 Pounds			285 Pounds					
1st	Zachary Parker	Fountain Valley	1st	Raymond Macias	Bishop Amat			
2nd	Mac Calavitta	Esperanza	2nd	Roman Damas	Chino			
3rd	Jacob Salcedo	Northview	3rd	Ethan Esparza	Marina			
4th	Dylan Moreno	Chino	4th	Anthony Troncoso	Northview			
5th	Kyle Sakuda	Sonora (La Habra)	5th	Levi Banuelos	Fullerton			
6th	Antonio Aramburu	Corona Del Mar	6th	Emiliano Gonzalez	Sonora (La Habra)			
7th	Odin Kenworthy	Westlake	7th	Dylan Bunbury	Fountain Valley			
8th	Harrison Roderick	Crespi Carmelite	8th	Logan Shoemaker	Thousand Oaks			



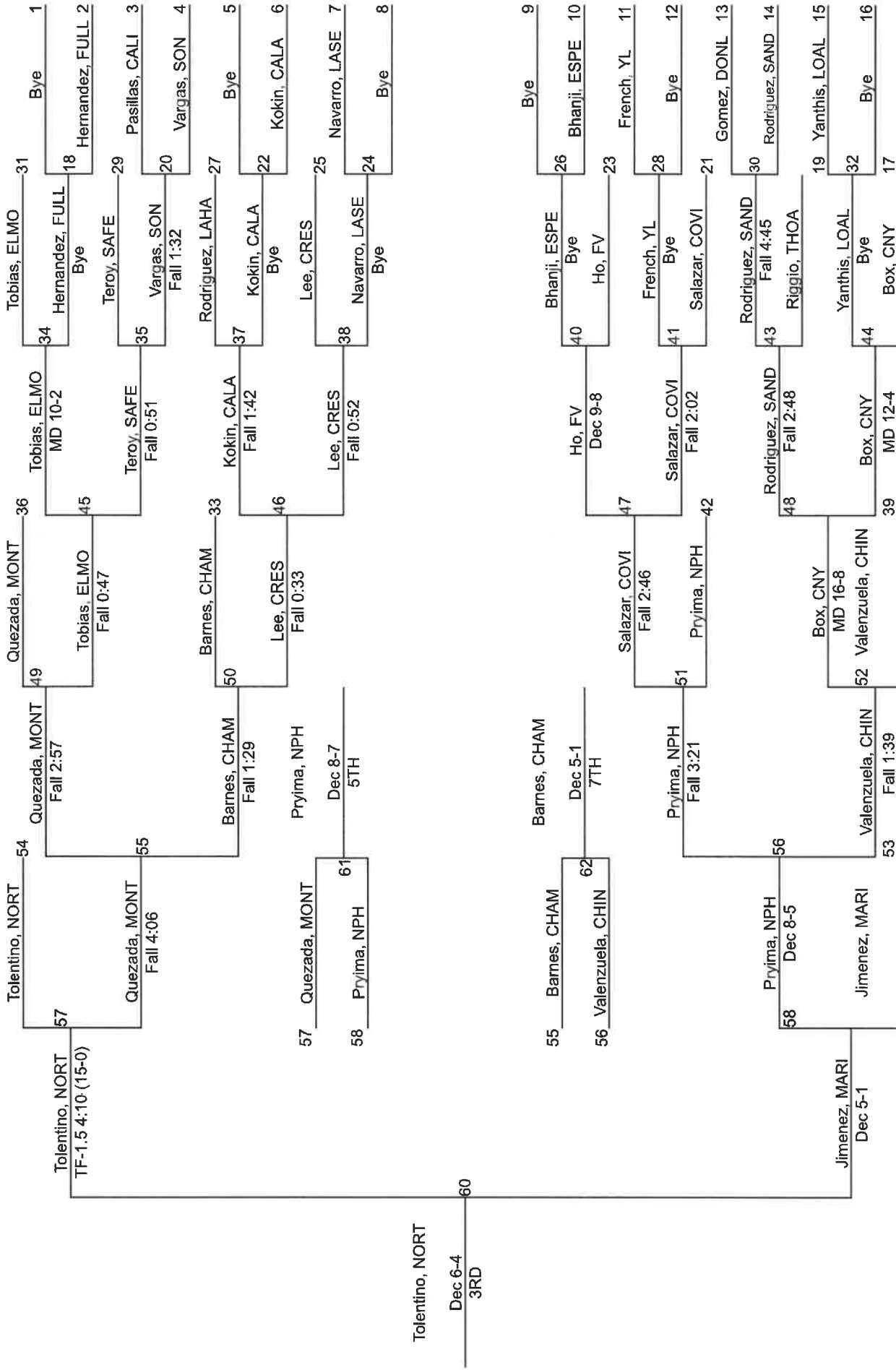

# 2022 CIF Individuals Central Division

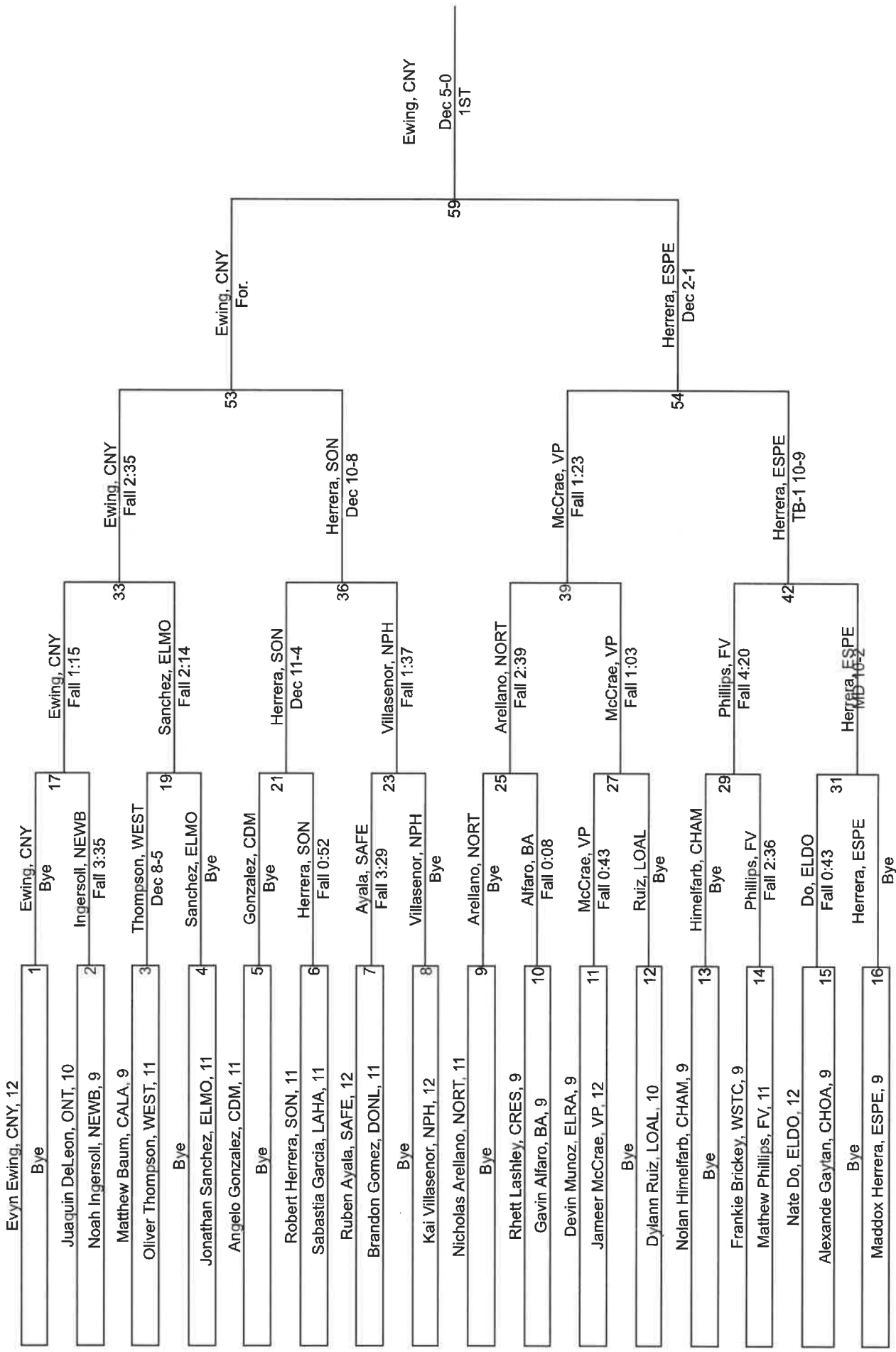



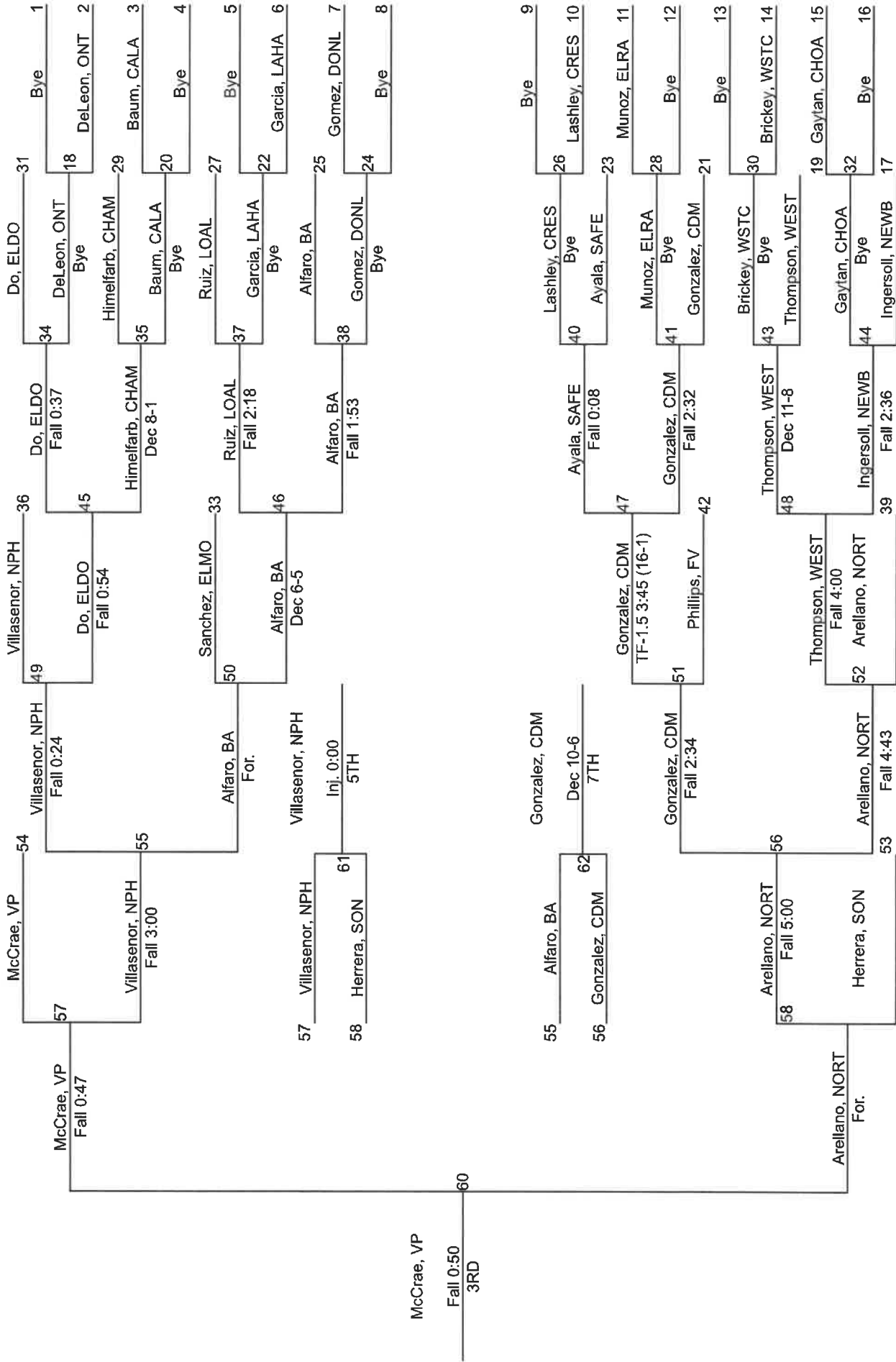

# 2022 CIF Individuals Central Division

# 120

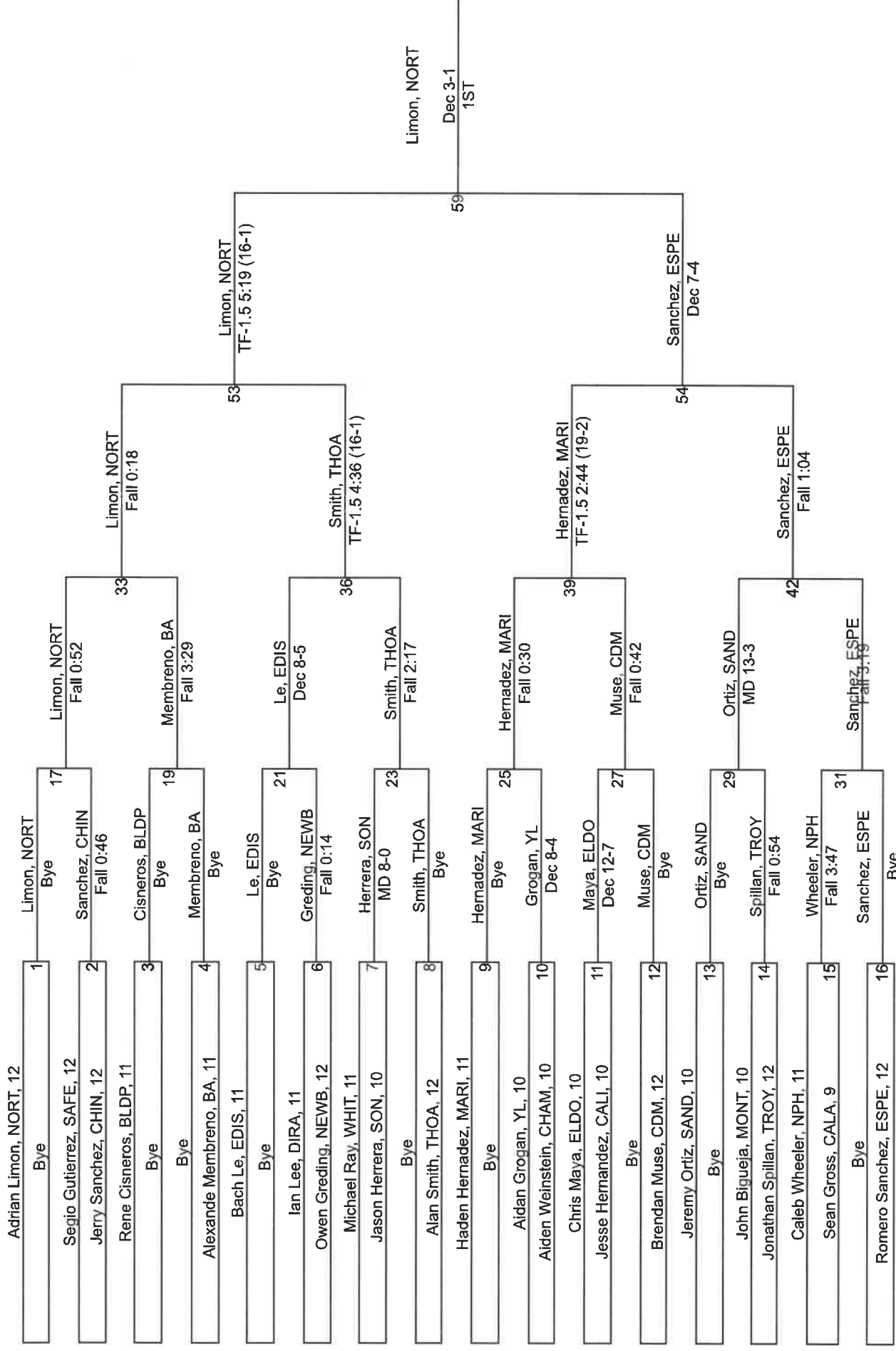



# 2022 CIF Individuals Central Division

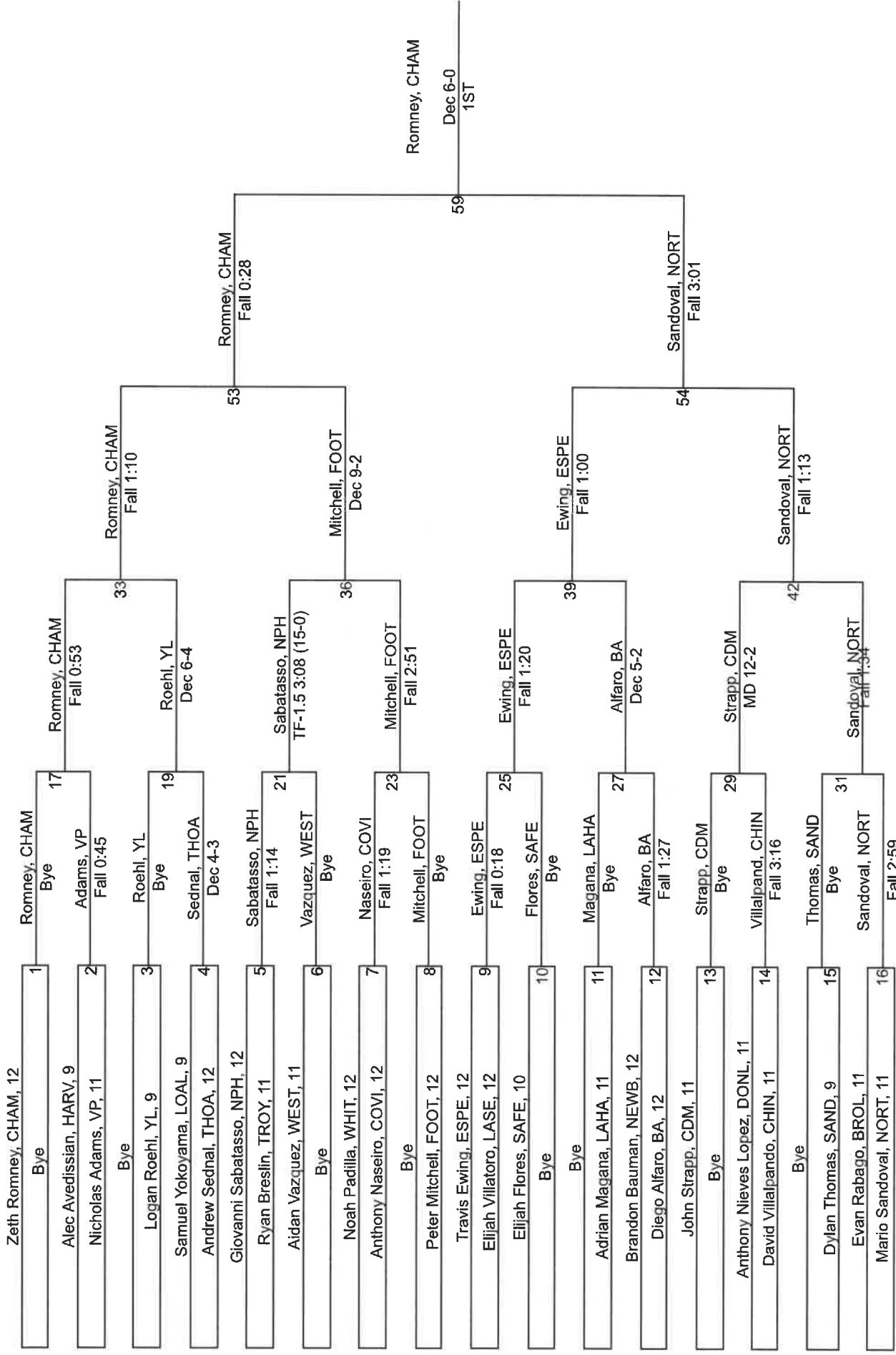



# 2022 CIF Individuals Central Division

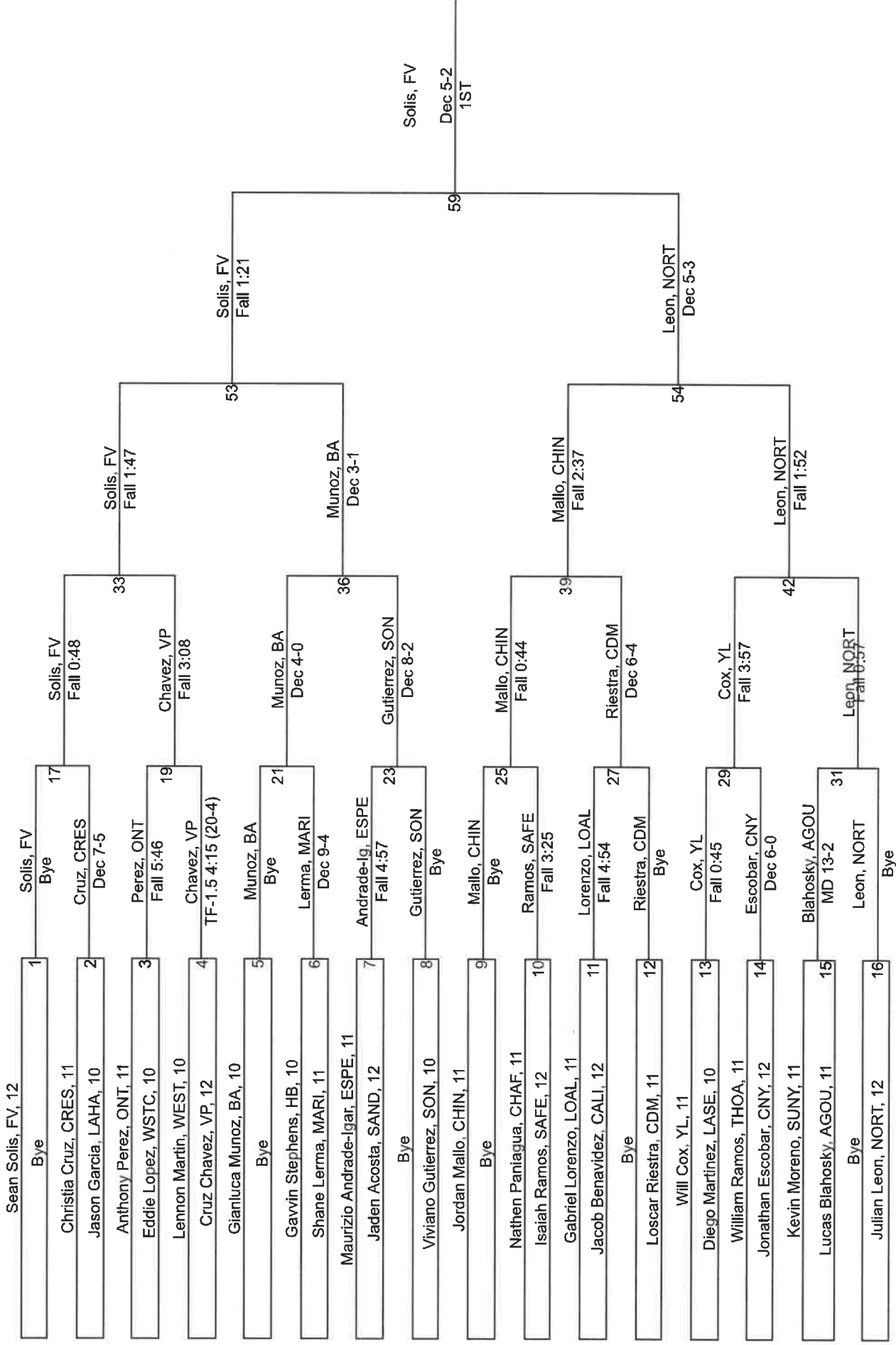





# 2022 CIF Individuals Central Division

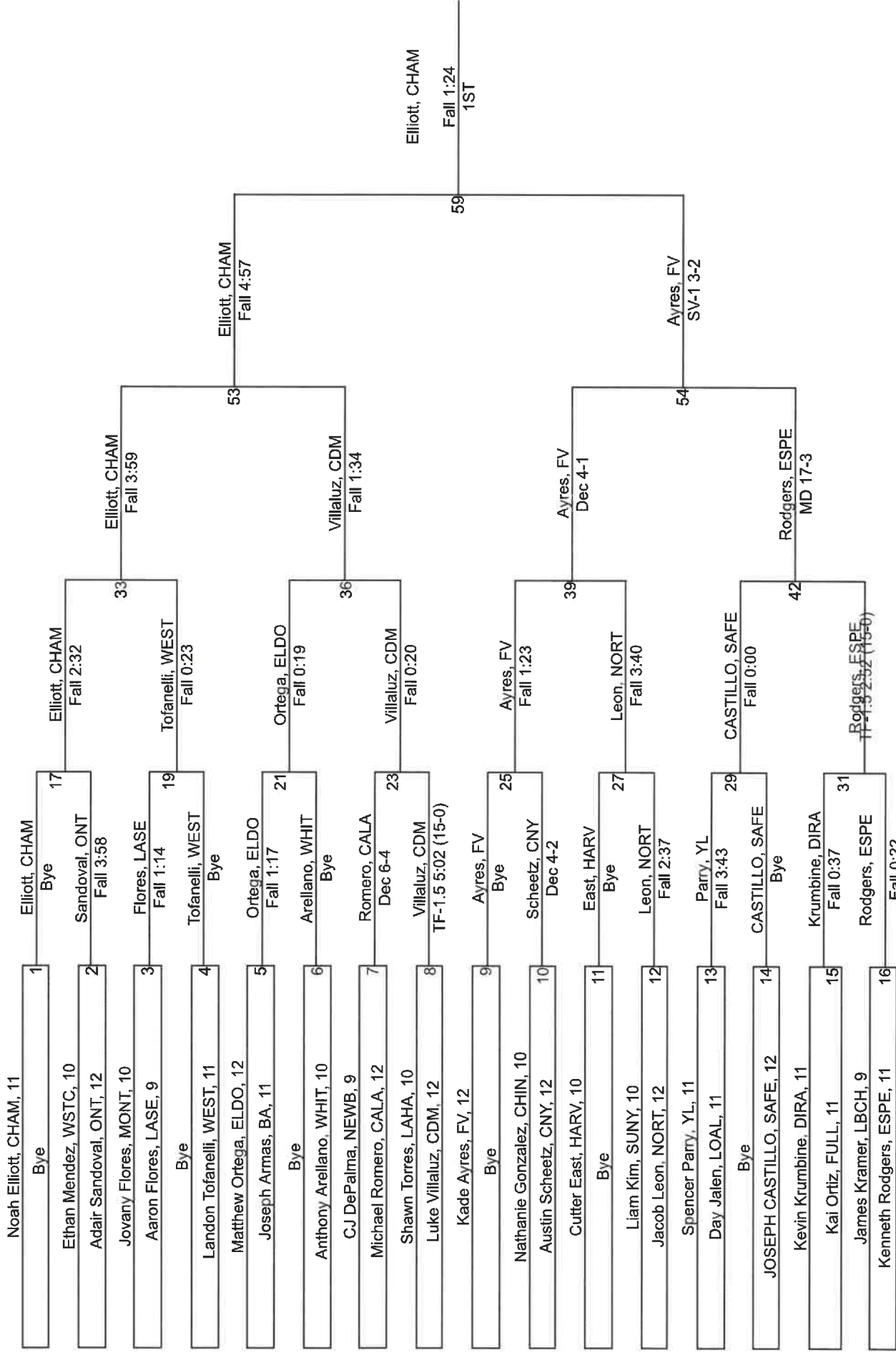

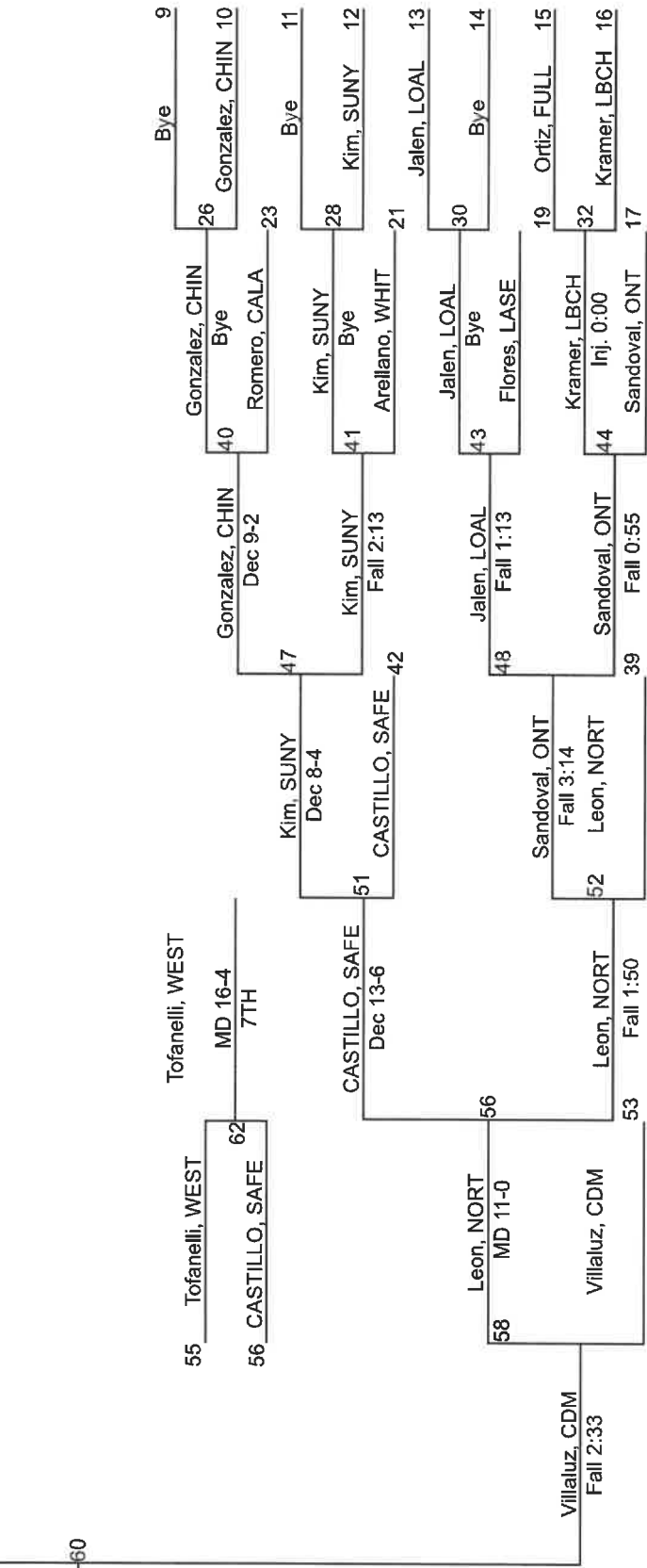
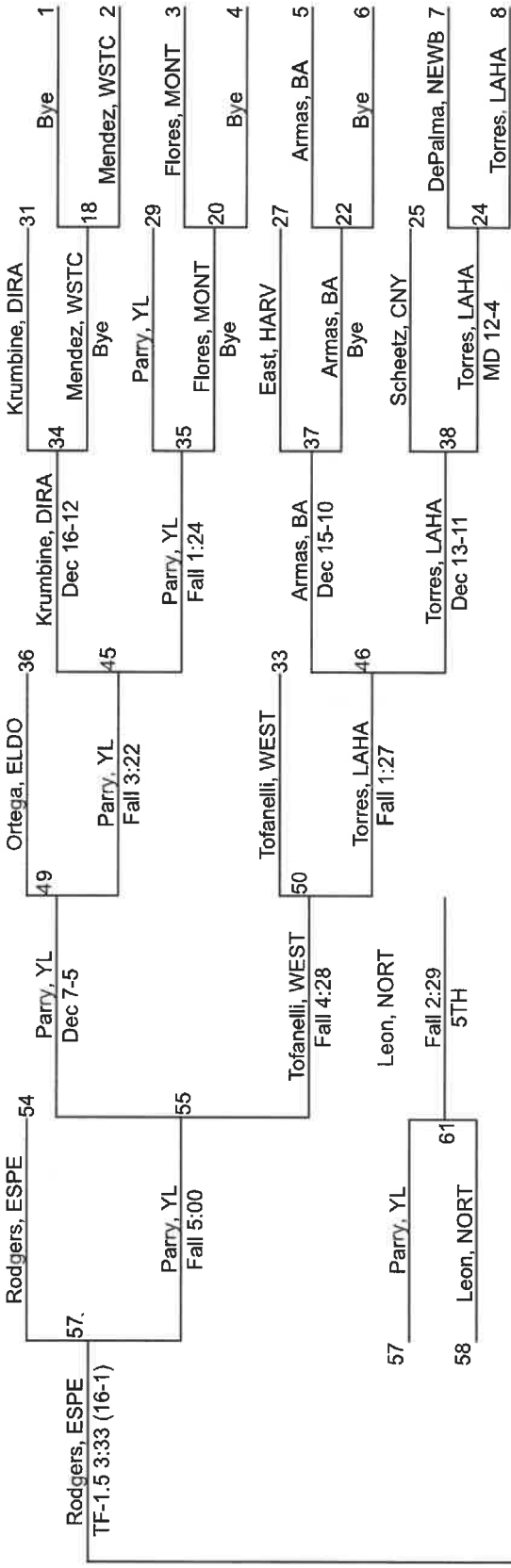

# 2022 CIF Individuals Central Division

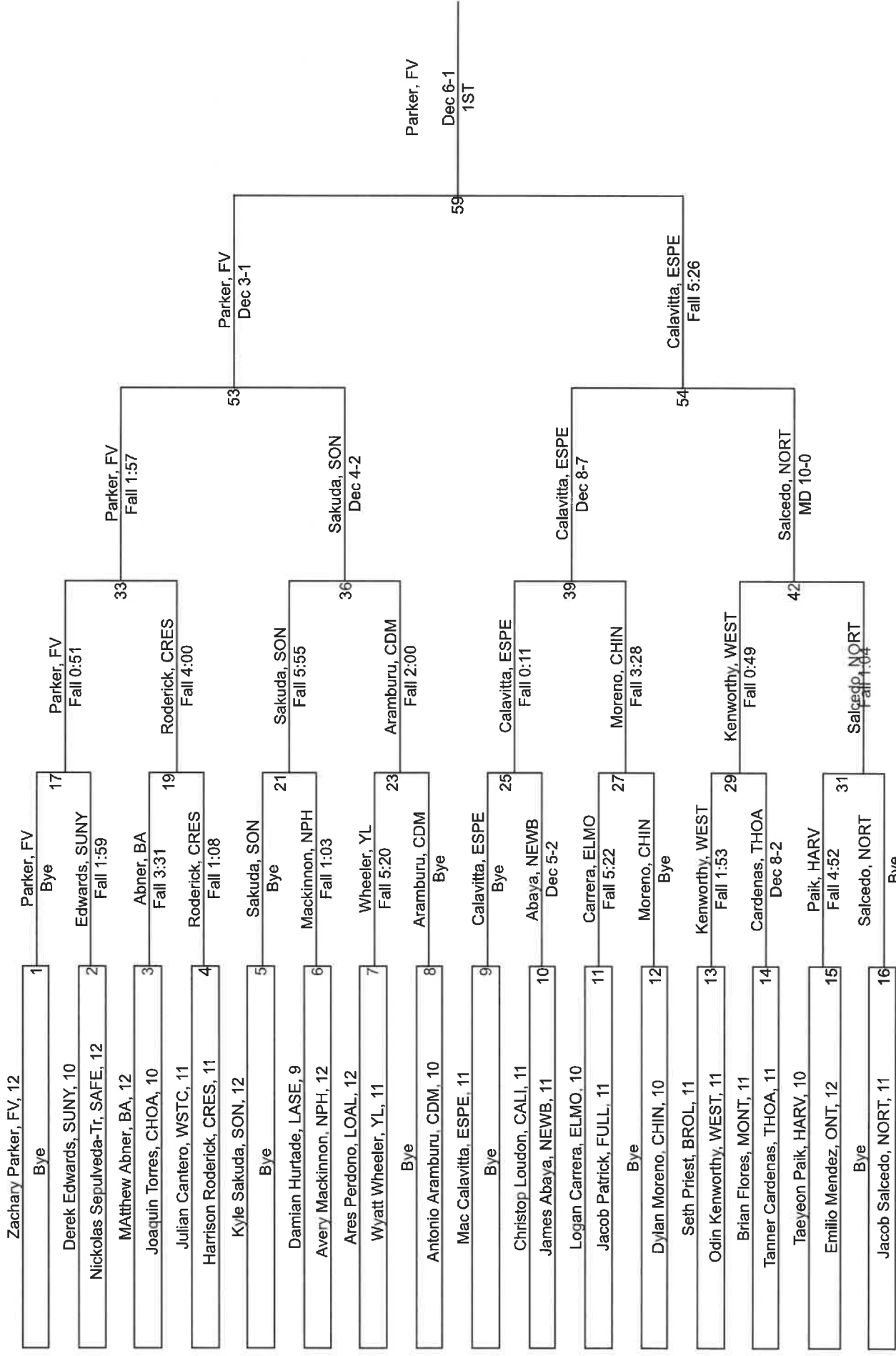



# 2022 CIF Individuals Central Division

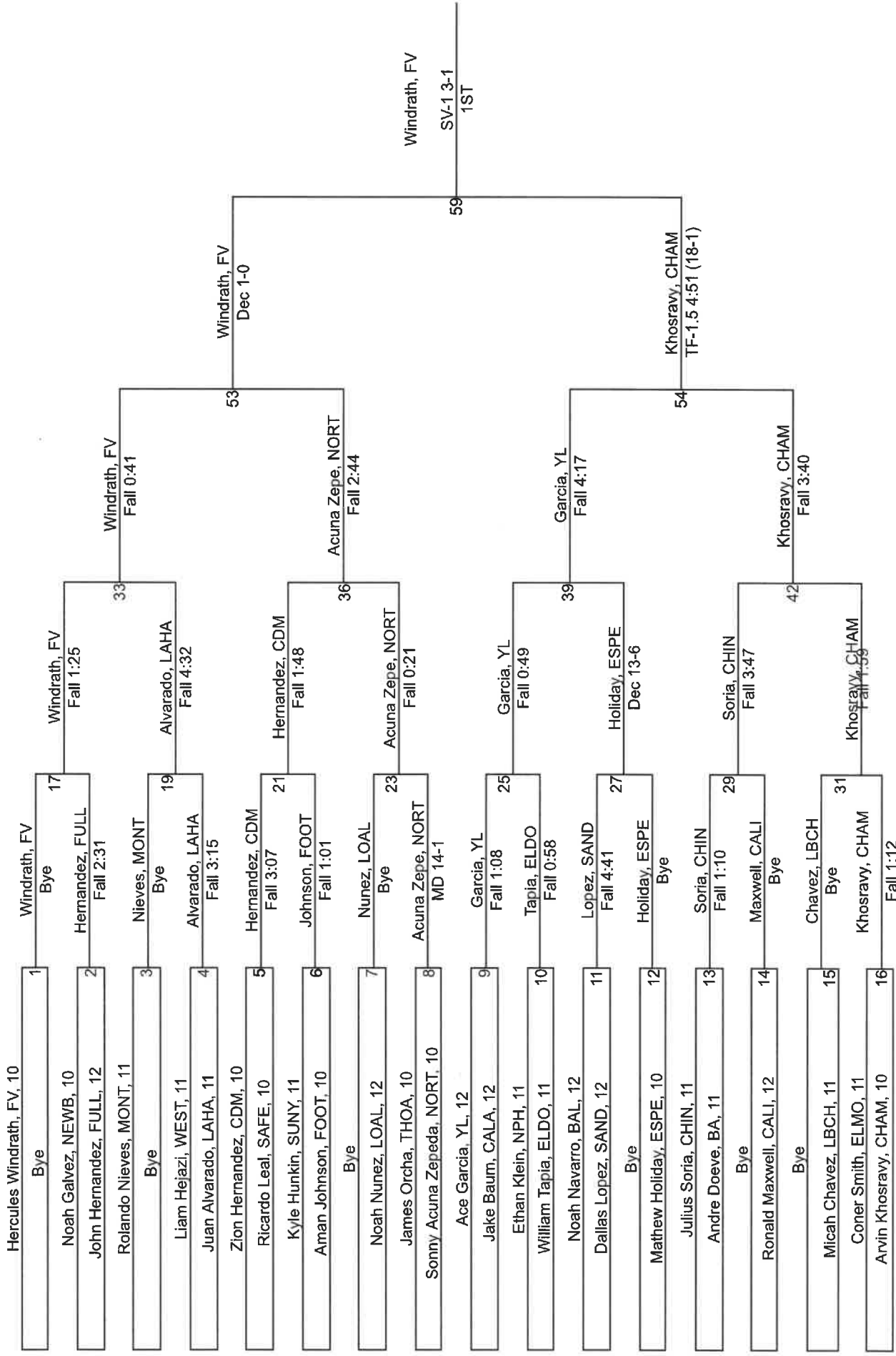





# 2022 CIF Individuals Central Division

160

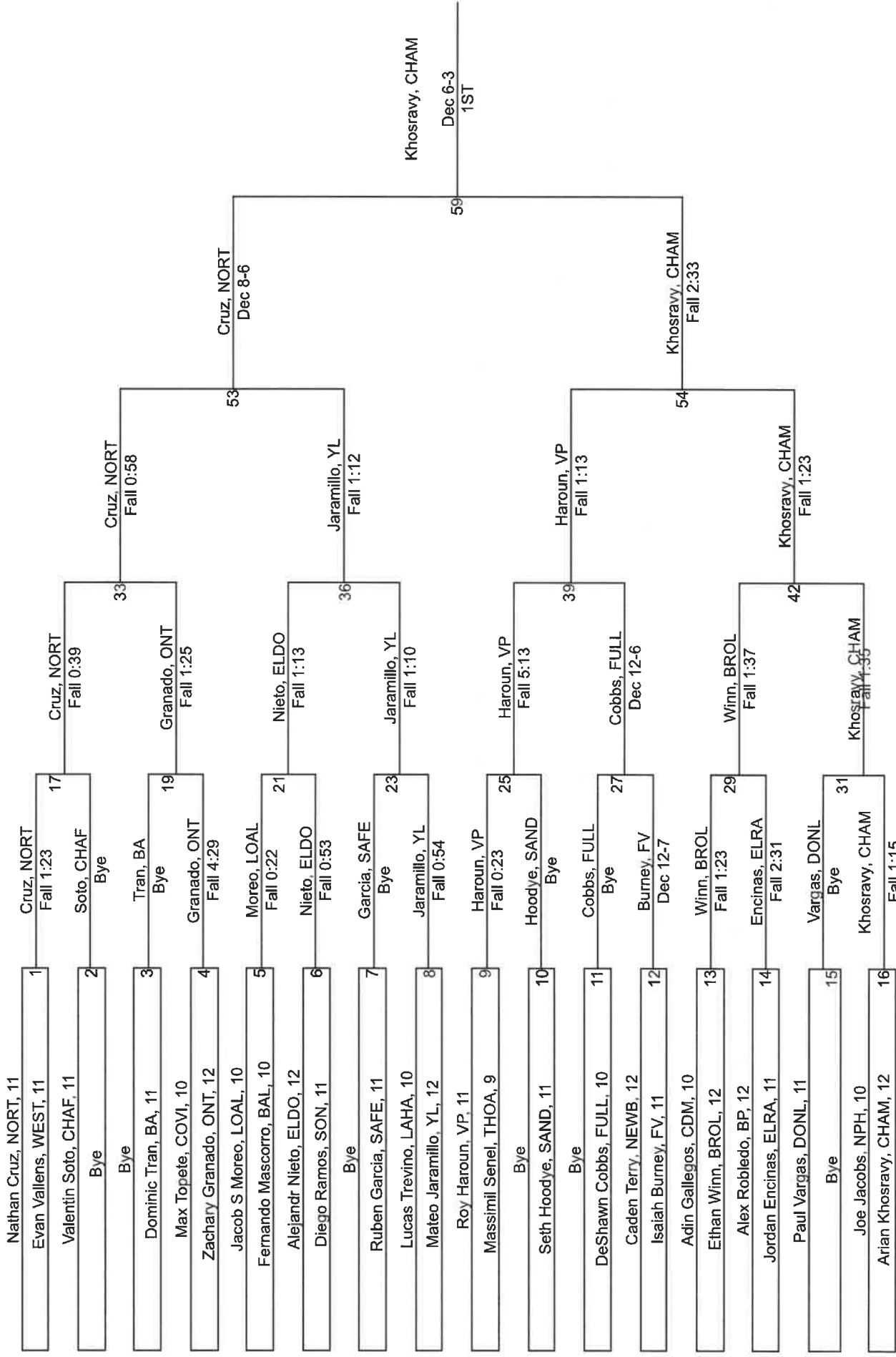



# 2022 CIF Individuals Central Division

170

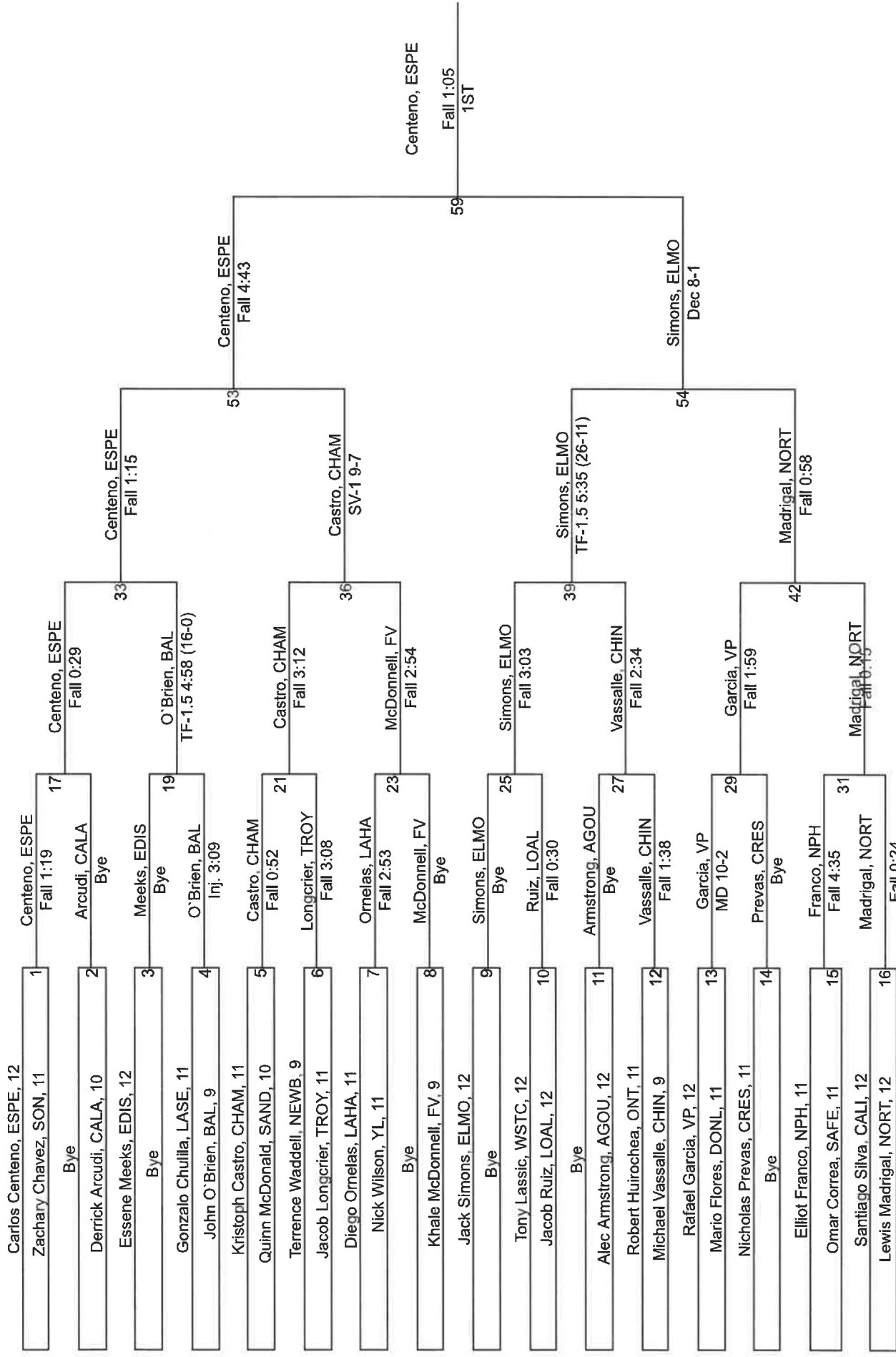

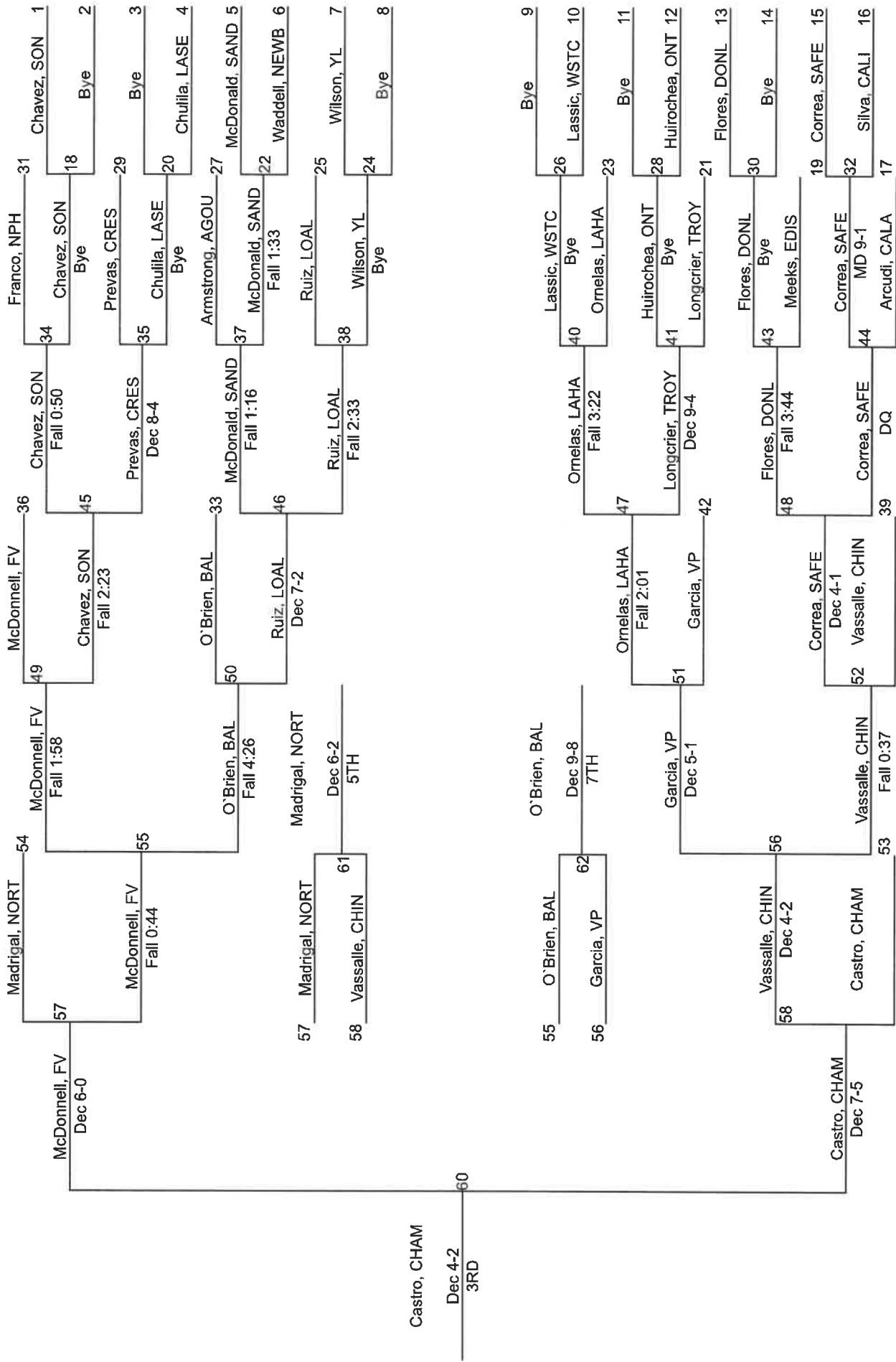

# 2022 CIF Individuals Central Division

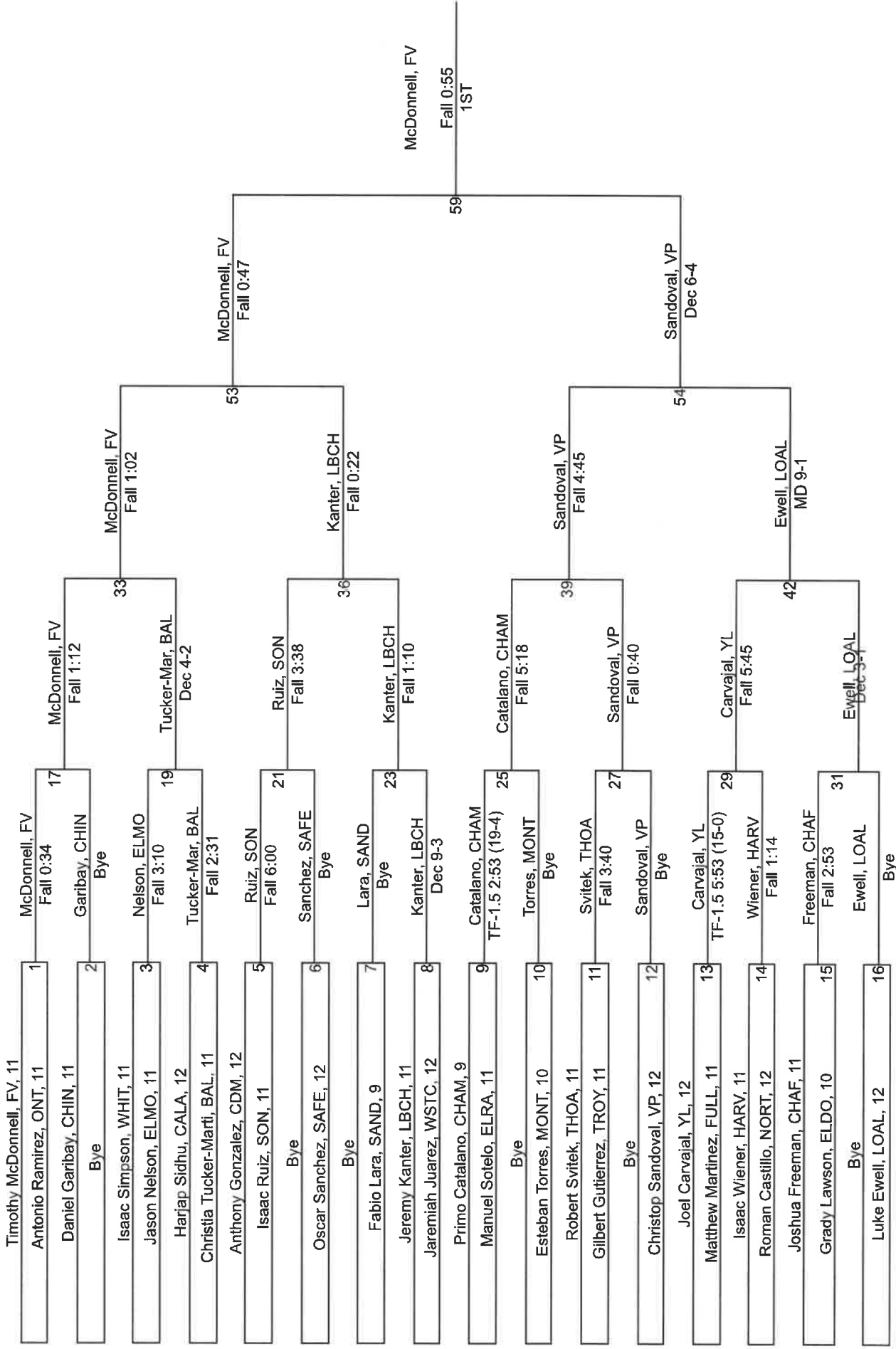





# 2022 CIF Individuals Central Division

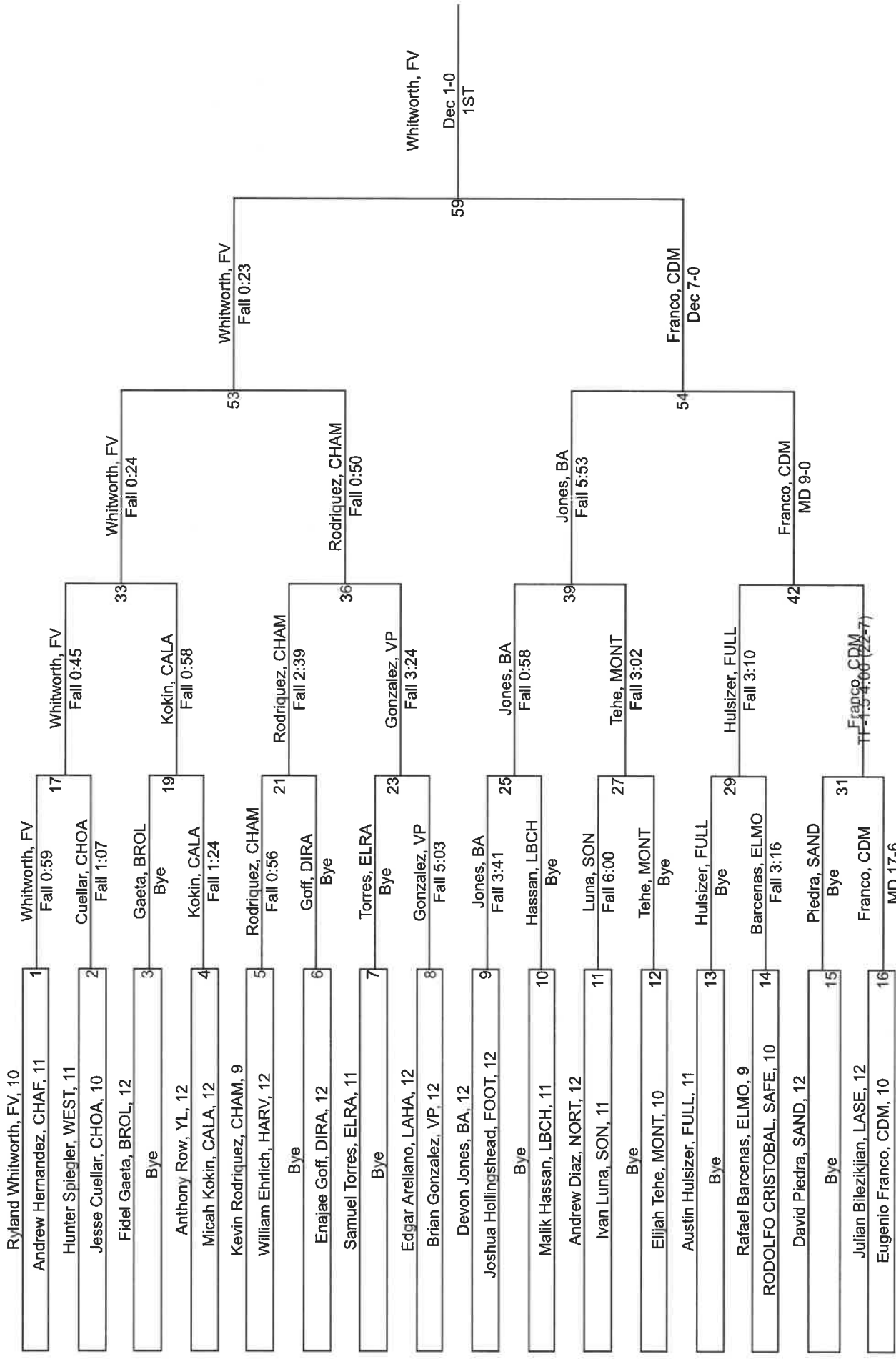



# 2022 CIF Individuals Central Division

# 220

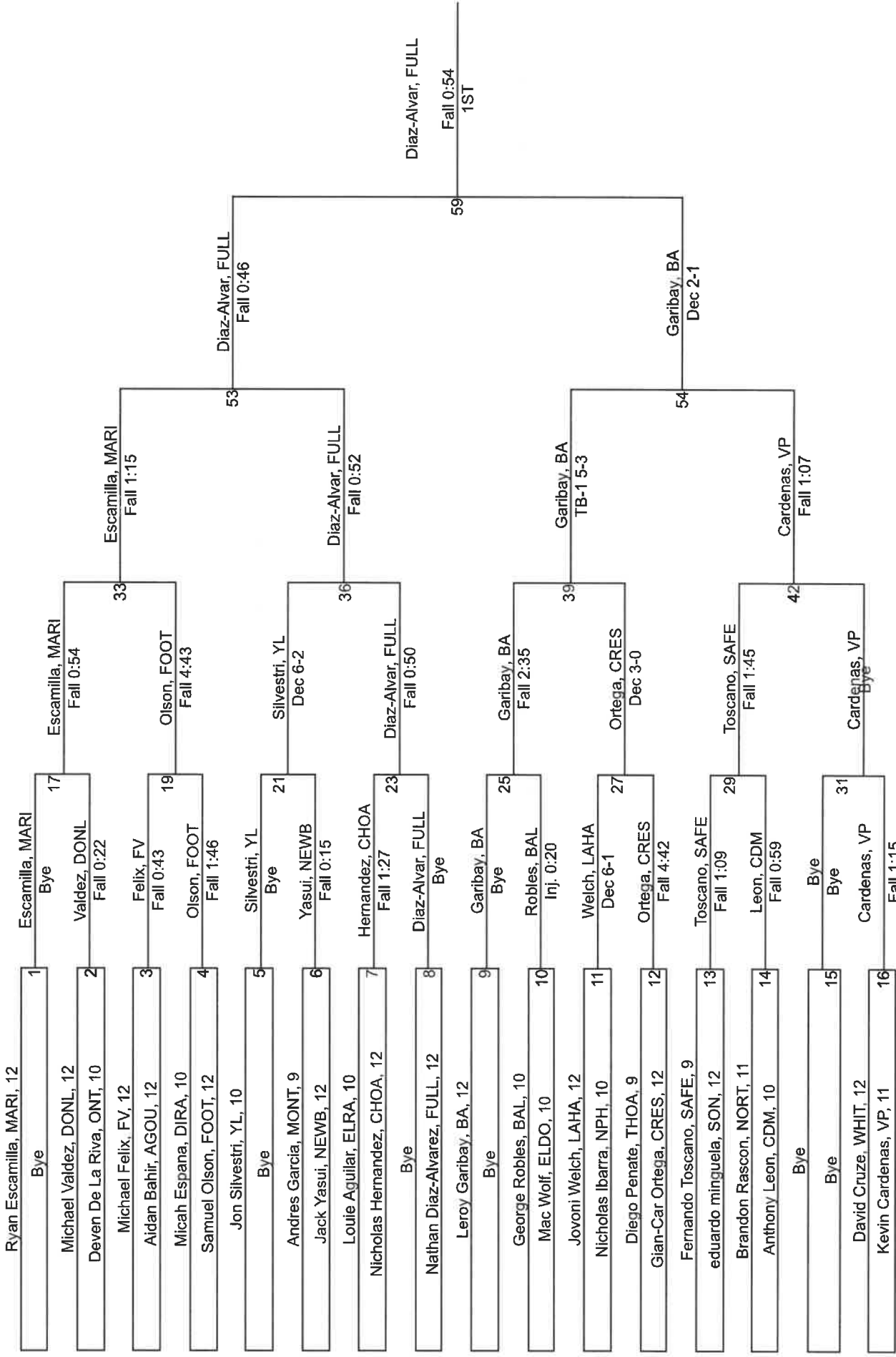

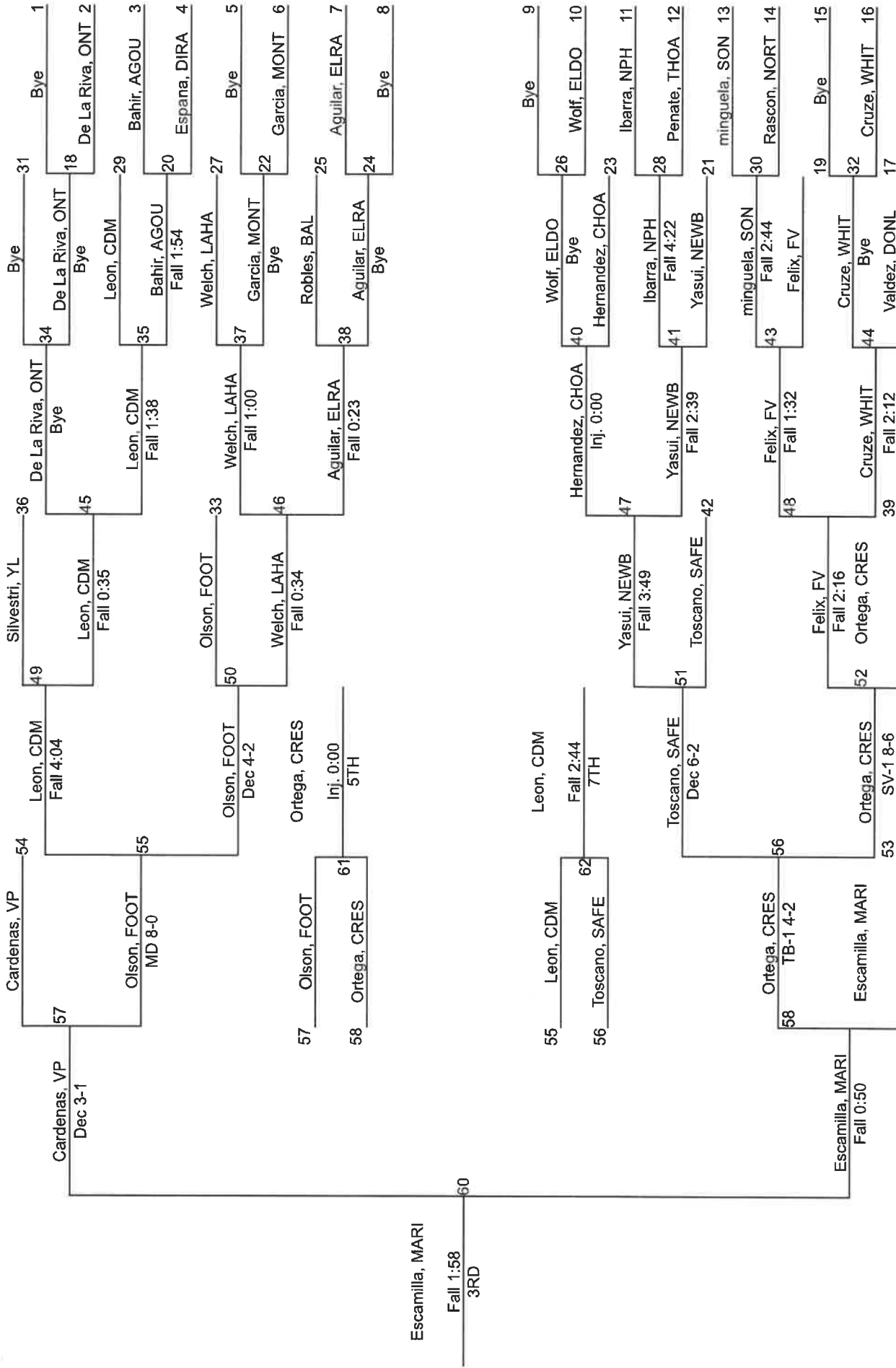

# 2022 CIF Individuals Central Division

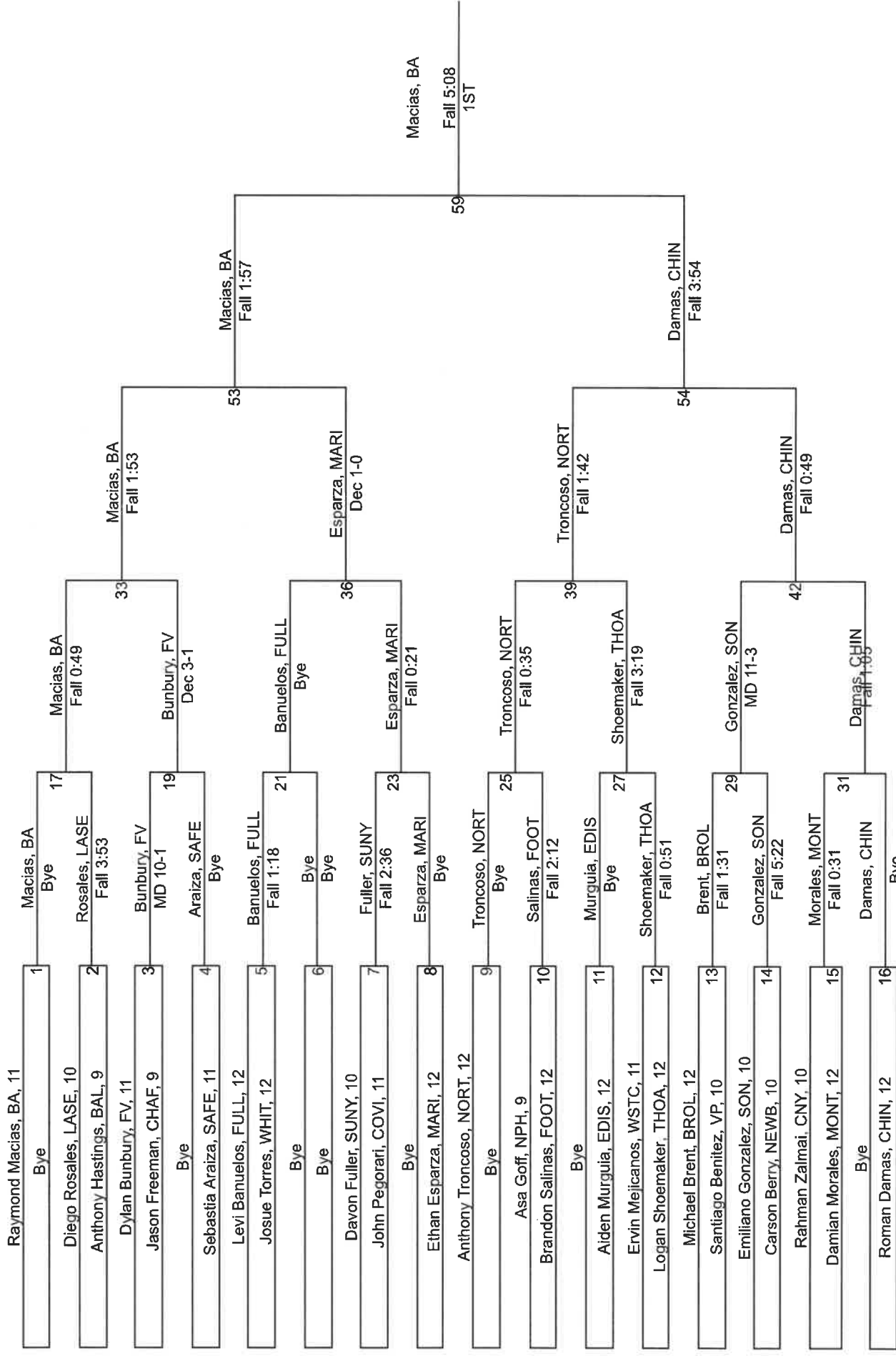



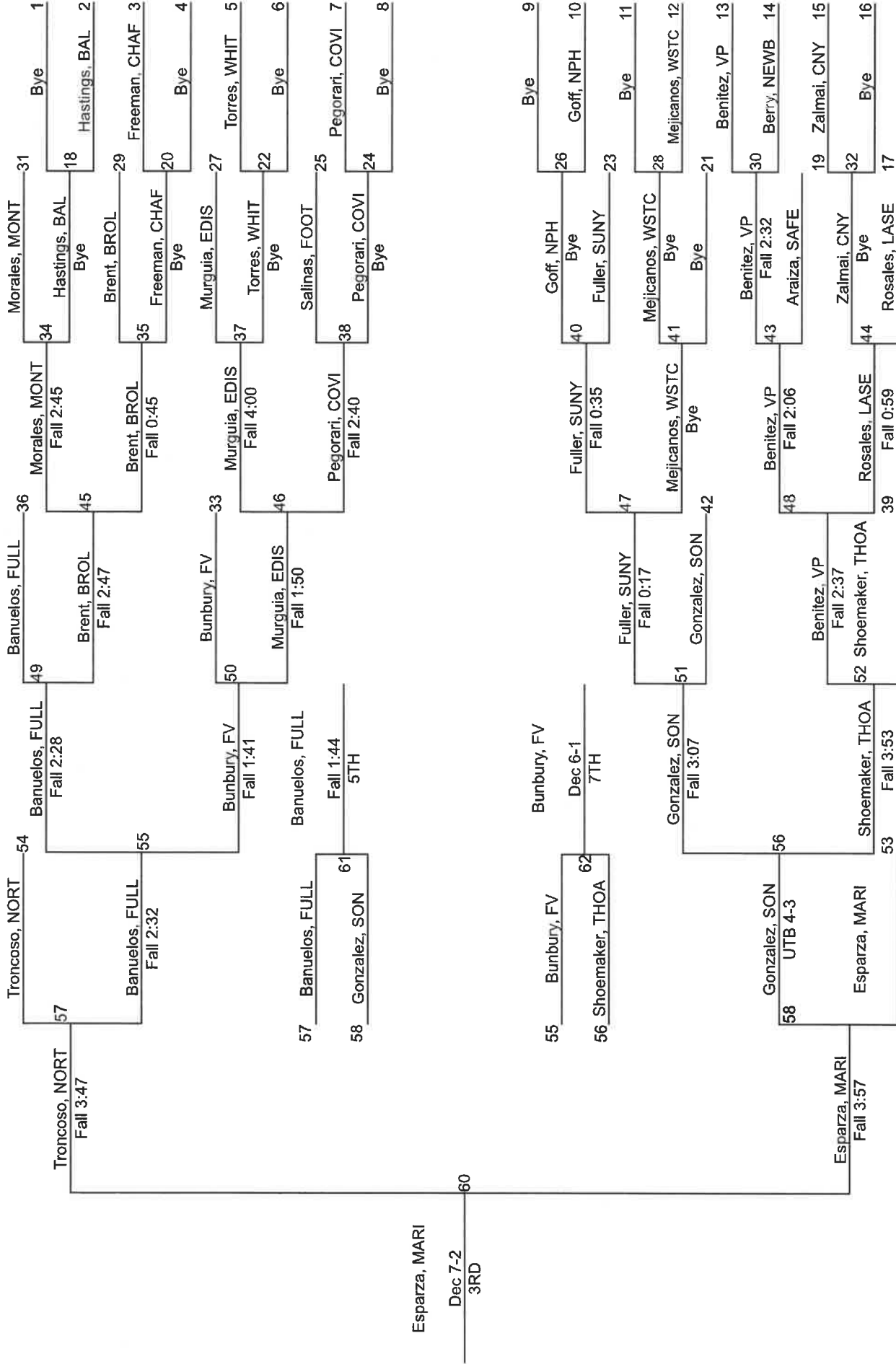

# CIF SS Boys Individuals-Coastal Division

Etiwanda High School  
February 11-12, 2022



Lower Weight Outstanding Wrestler

Gavin Ibarra  
Eleanor Roosevelt HS  
145 Pounds

Upper Weight Outstanding Wrestler

Dayton Ortiz  
Rancho Cucamonga HS  
160 Pounds

Placers						Team Score Final	
<b>106 Pounds</b>			<b>152 Pounds</b>			1 Centennial/Corona	277
1st	Jason Saenz	Eleanor Roosevelt	1st	Javier Montes	Centennial/Corona	2 Eleanor Roosevelt	248
2nd	Julian Santana	Los Osos	2nd	Brevin Blair	Redondo Union	3 Laguna Hills	205.5
3rd	Dario Sanchez	Santiago/Corona	3rd	Damian Soto	Barstow	4 Etiwanda	204
4th	Hernan Estrada	Laguna Hills	4th	Kevin Courseault	Etiwanda	5 Westminster	151
5th	Jeremiah Marquez	Westminster	5th	Joseph Perez	Chino Hills	6 Norco	147
6th	Tate Lowry	Redondo Union	6th	Amin Derekshah	University	7 Redondo Union	135
7th	Hugo Rodriguez	Victor Valley	7th	Joseph Cruz	Victor Valley	8 Victor Valley	124
8th	Joshua Delgado	Godinez	8th	Kai Necci	Santa Monica	9 Segerstrom	102.5
<b>113 Pounds</b>			<b>160 Pounds</b>			10 Los Osos	88
1st	Mateo Ochoa	Martin Luther King Jr	1st	Dayton Ortiz	Rancho Cucamonga	11 Rancho Cucamonga	73.5
2nd	Adian Asuncion	Eleanor Roosevelt	2nd	Noah Vasquez	Eleanor Roosevelt	12 Irvine	68
3rd	Bryce Gonzales	Norco	3rd	Benedek Magyar	Irvine	13 Martin Luther King Jr	63
4th	Kamrin Lovio	Segerstrom	4th	Adrien Rodriguez	Garden Grove	14 Peninsula	61
5th	Syrus Singh	Laguna Hills	5th	Anthony Porter	Martin Luther King Jr	15 Beverly Hills	58
6th	Johnny Martinez	Jurupa Valley	6th	Koby Kranis	Beverly Hills	16 Garden Grove	54
7th	Tovi Cacal	Peninsula	7th	Connor Kaplan	Redondo Union	16 University	54
8th	Ryan Kahn	Etiwanda	8th	Alexsander Lopez	Indian Springs	18 Santa Monica	53
<b>120 Pounds</b>			<b>170 Pounds</b>			19 Jurupa Valley	48
1st	Jacob Bell	Etiwanda	1st	Carson Thoe	Laguna Hills	19 Mira Costa	48
2nd	Diego Marcelo	Centennial/Corona	2nd	John Grundmeyer	Norco	19 Santiago/Corona	48
3rd	Kris Zamora	Peninsula	3rd	Ray Montes	Centennial/Corona	22 Barstow	47
4th	Michael Williams	Eleanor Roosevelt	4th	Demetri Cantrell	Eleanor Roosevelt	23 Damien	46
5th	Roberto Garcia	Victor Valley	5th	Devin McCaw	Los Osos	24 Portola	40
6th	Brett Berndt	Redondo Union	6th	Bryan Gomez	Etiwanda	25 Upland	39
7th	Rodolfo Magarin	Segerstrom	7th	Landen Degennaro	Martin Luther King Jr	26 Sierra Vista	36
8th	Moises Sanchez	Laguna Hills	8th	Kenny Cutler	Irvine	27 Woodbridge	35.5
<b>126 Pounds</b>			<b>182 Pounds</b>			28 Corona	35
1st	Thomas Le	Laguna Hills	1st	Caleb Smith	Etiwanda	29 Beckman	32
2nd	David Guerra	Centennial/Corona	2nd	Jakob Hand	Centennial/Corona	30 Big Bear	28
3rd	Jose Garcia	Victor Valley	3rd	Ruben Vasquez	Westminster	31 Nogales	26
4th	Javier Velez	Westminster	4th	Dontae Sheng	Peninsula	32 Chino Hills	20.5
5th	Diego S Villalobos	Jurupa Valley	5th	Austin South	Norco	33 Calvary Chapel Downey	16
6th	Julian Aguilar	Eleanor Roosevelt	6th	Davin Ito	Eleanor Roosevelt	33 Granite Hills	16
7th	Austin McSwain	Etiwanda	7th	Abel Gonzalez	Segerstrom	33 Indian Springs	16
8th	Alexander Virtue	Mira Costa	8th	Jaxson Lockwood	Santa Monica	36 Northwood	15.5
<b>132 Pounds</b>			<b>195 Pounds</b>			37 AB Miller	15
1st	Ethan Qureshi	Portola	1st	Giovanni Martinez	Centennial/Corona	37 Webb	15
2nd	Enzo Fukanaga	Woodbridge	2nd	Javier Gonzalez	Norco	39 Godinez	14
3rd	Isaac Rea	Norco	3rd	Matt Kim	Laguna Hills	39 Silverado	14
4th	Brian Leon	Eleanor Roosevelt	4th	Stephie Bonds	Etiwanda	41 Excelsior Charter	8
5th	Cade Braun	Centennial/Corona	5th	Tim Morris	Rancho Cucamonga	42 Katella	6
6th	Gabe Balingit	Etiwanda	6th	Diego Garcia	Barstow	43 Duarte	4
7th	Erik Torres	Westminster	7th	Lopu Sagapolu	Silverado	43 Rubidoux	4
8th	Artemis Shmuel	Segerstrom	8th	Michael Trejo	Eleanor Roosevelt	45 Gladstone	3
<b>138 Pounds</b>			<b>220 Pounds</b>			45 Pacific	3
1st	Aldo Quintero	Centennial/Corona	1st	Cristian Brito	Westminster	47 Adelanto	0
2nd	Carlos Fajardo	Laguna Hills	2nd	Nick Salabaj	Damien	47 Azusa	0
3rd	Nathaniel Chang	Corona	3rd	Josue Torres	Sierra Vista	47 Ocean View	0
4th	Avian Singh	Victor Valley	4th	Dylan Avila	Segerstrom		
5th	Victor Figueroa	Westminster	5th	Dan Menache	Beverly Hills		
6th	Collin Cruz	Redondo Union	6th	Anthony Cerna	Garden Grove		
7th	Isaiah Rea	Norco	7th	Benjamin Ross	Mira Costa		
8th	Jacob Balingit	Etiwanda	8th	Matt Mathew	Centennial/Corona		
<b>145 Pounds</b>			<b>285 Pounds</b>				
1st	Gavin Ibarra	Eleanor Roosevelt	1st	Isaac Lopez	Centennial/Corona		
2nd	Evan Manzo	Etiwanda	2nd	Andrew Hernandez	Eleanor Roosevelt		
3rd	Gino Martinez	Centennial/Corona	3rd	Oliver Jacobs V	Nogales		
4th	Aaron Ramirez	Victor Valley	4th	Zachary Haughey	University		
5th	Tobe Huynh	Westminster	5th	Justin Ky	Redondo Union		
6th	David Jensen	Santa Monica	6th	Arthur Avila	Upland		
7th	Zach Chacon	Laguna Hills	7th	Larry Hyland	Damien		
8th	Brock Morishige	Redondo Union	8th	Jesus Martinez	Laguna Hills		

# 2022 CIF-SS Boys Individuals Coastal Division

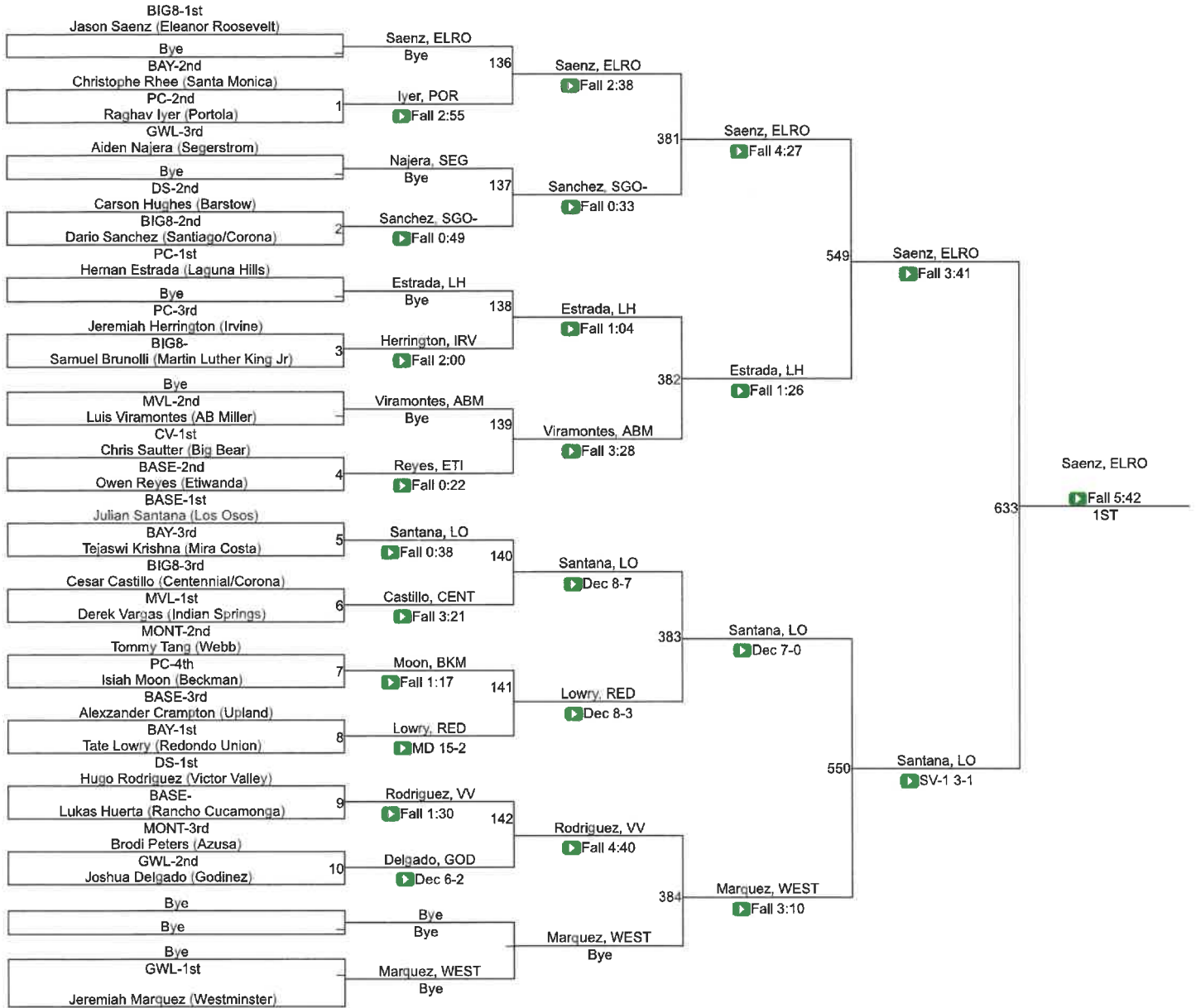

# 106

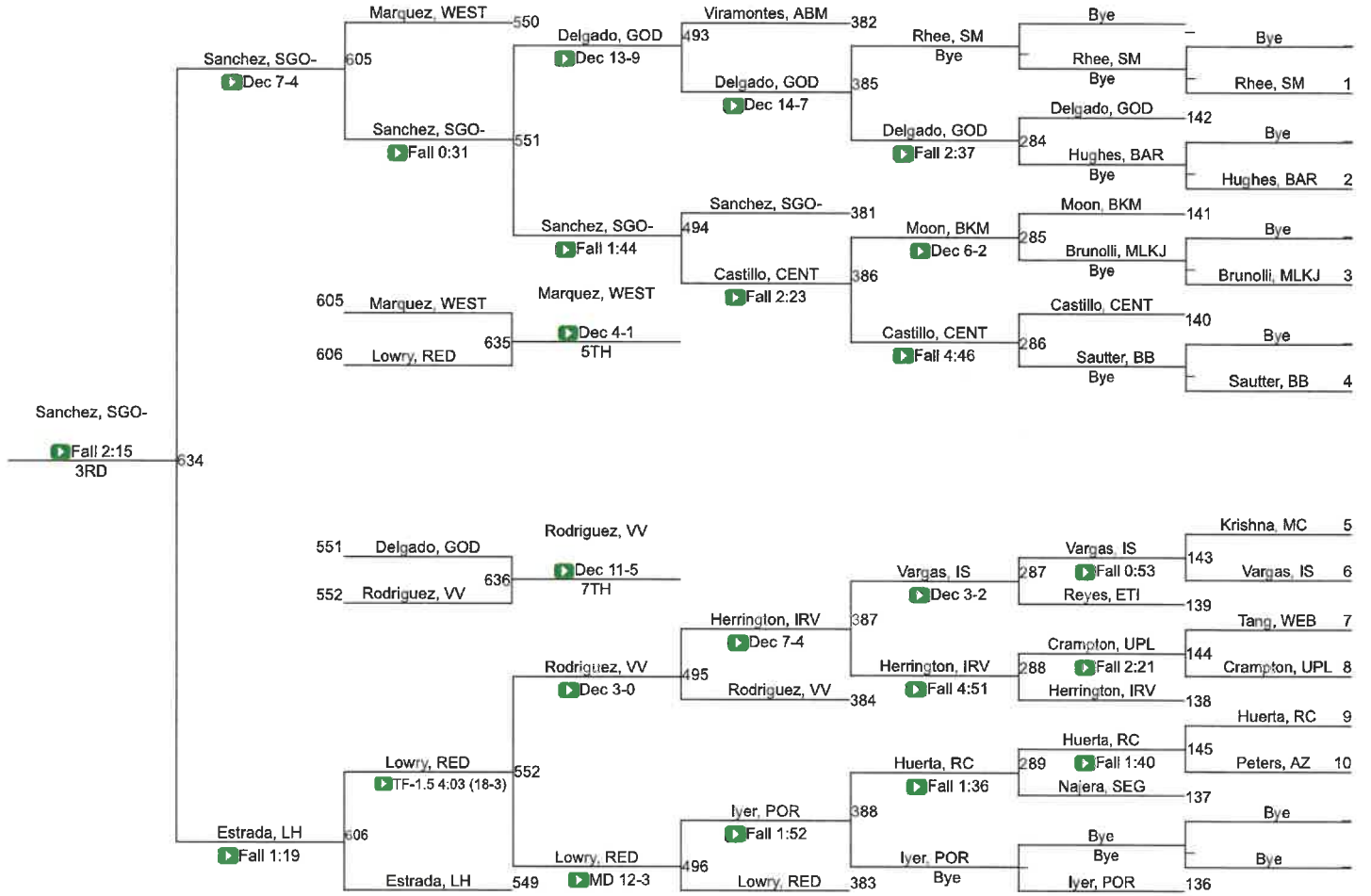

# 2022 CIF-SS Boys Individuals Coastal Division

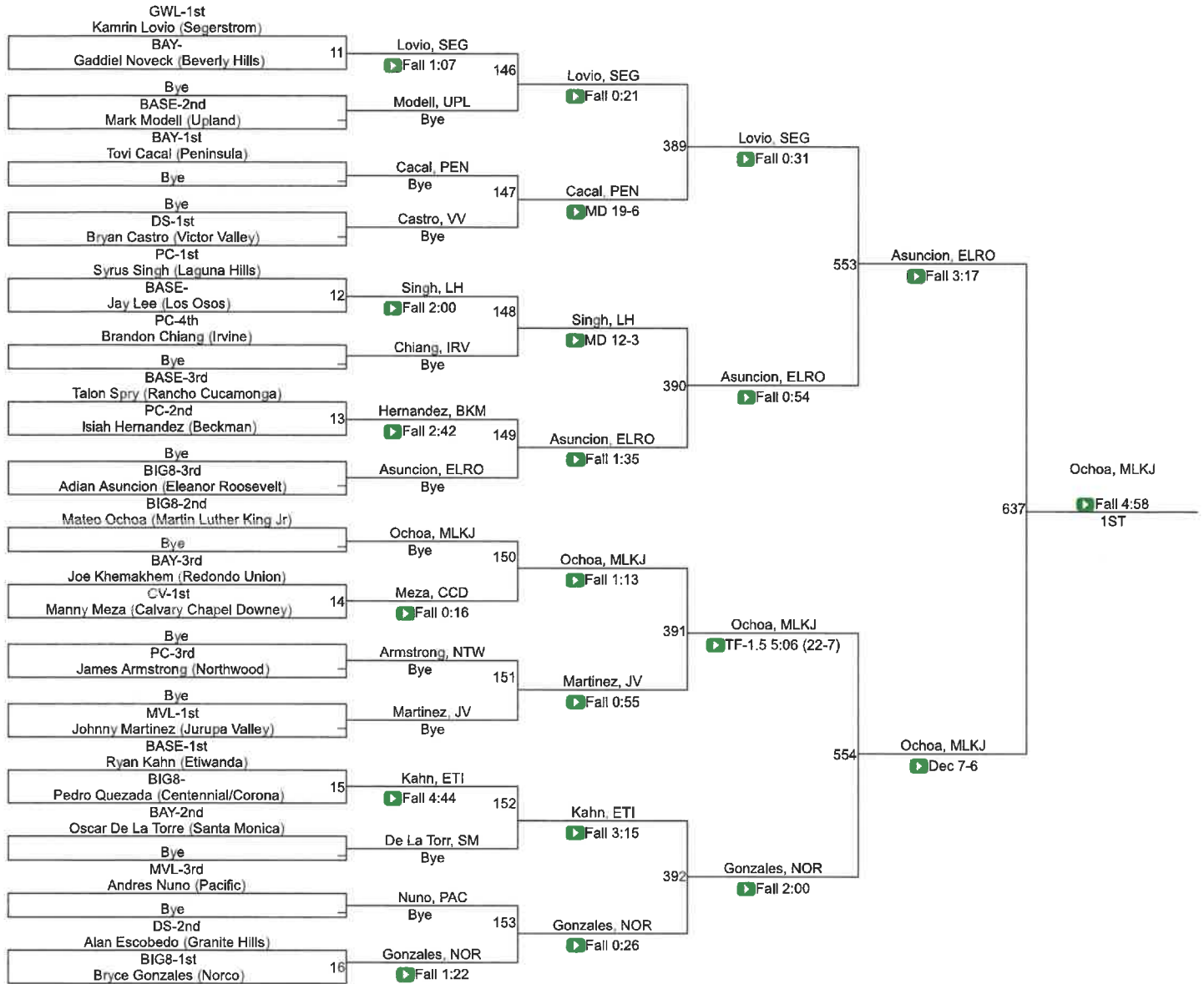

113

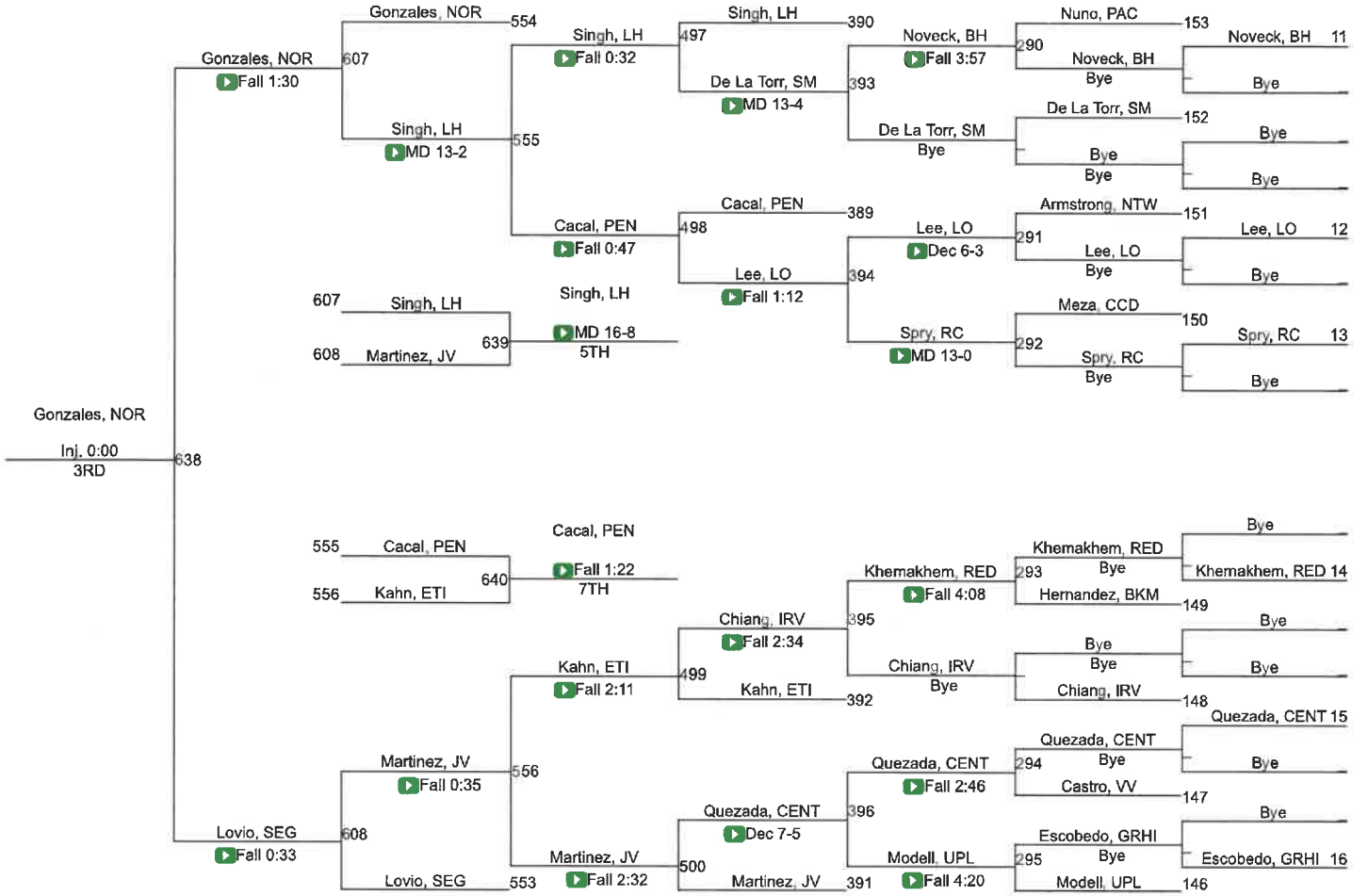

# 2022 CIF-SS Boys Individuals Coastal Division

120

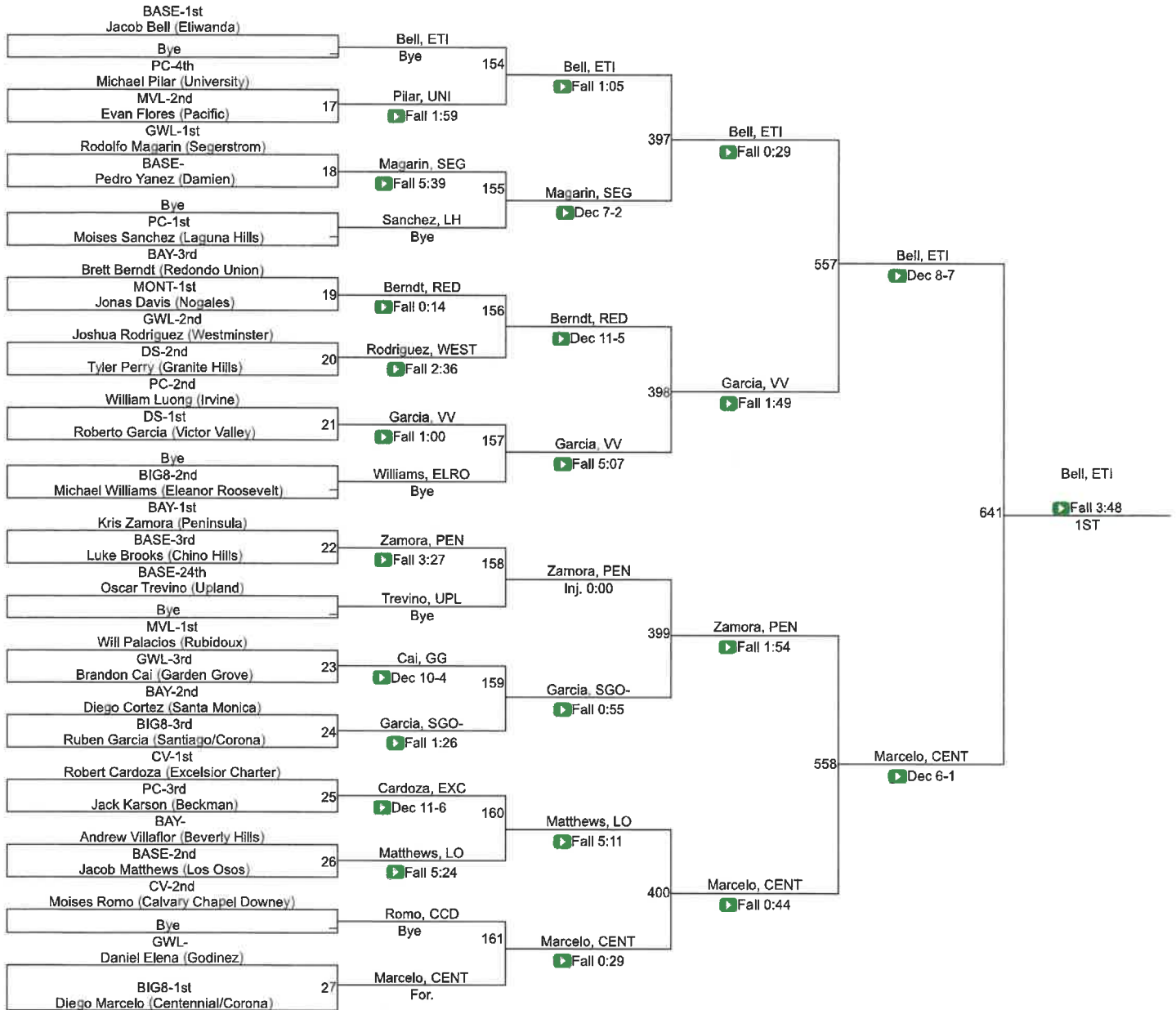



120

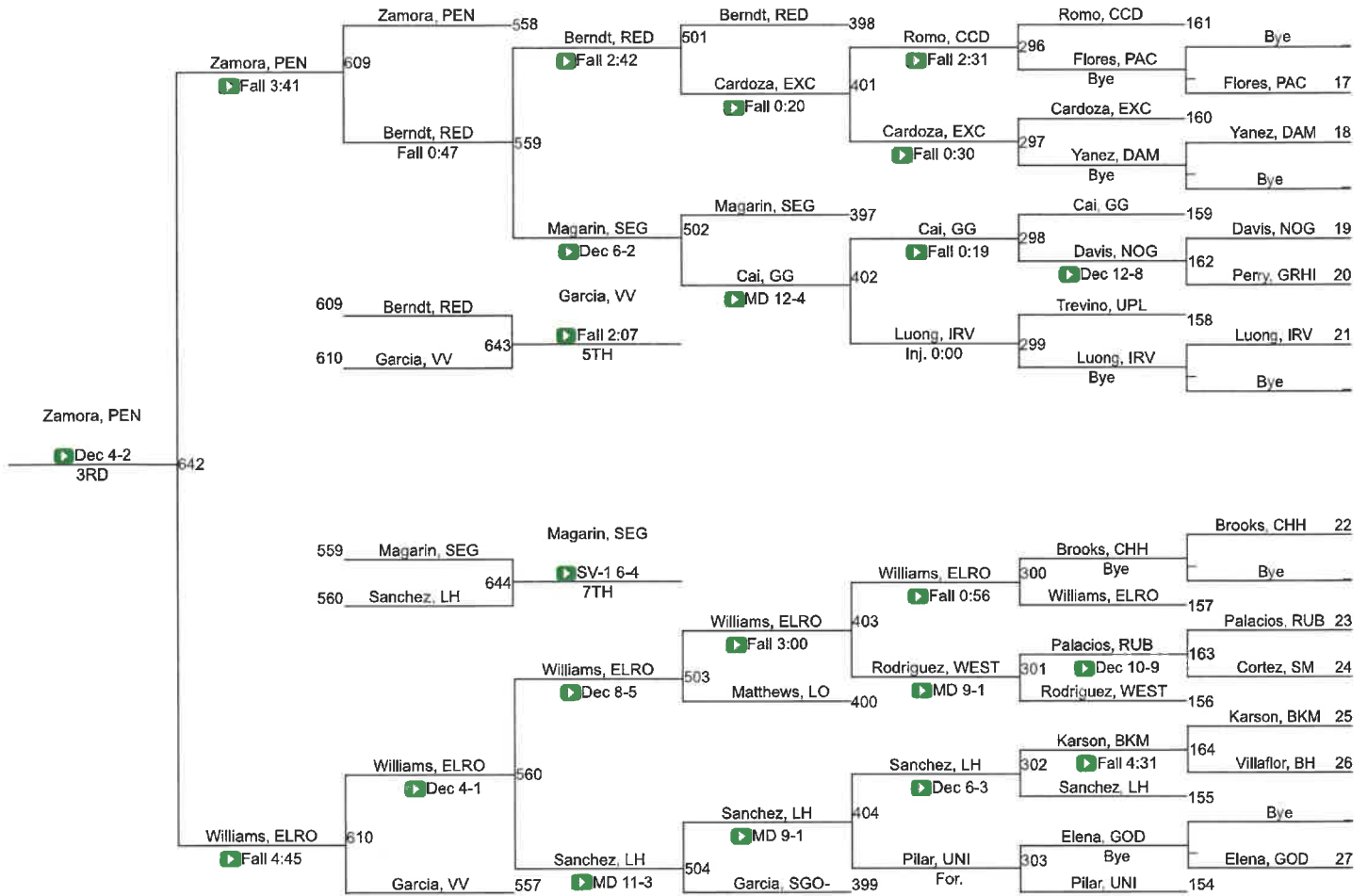

# 2022 CIF-SS Boys Individuals Coastal Division

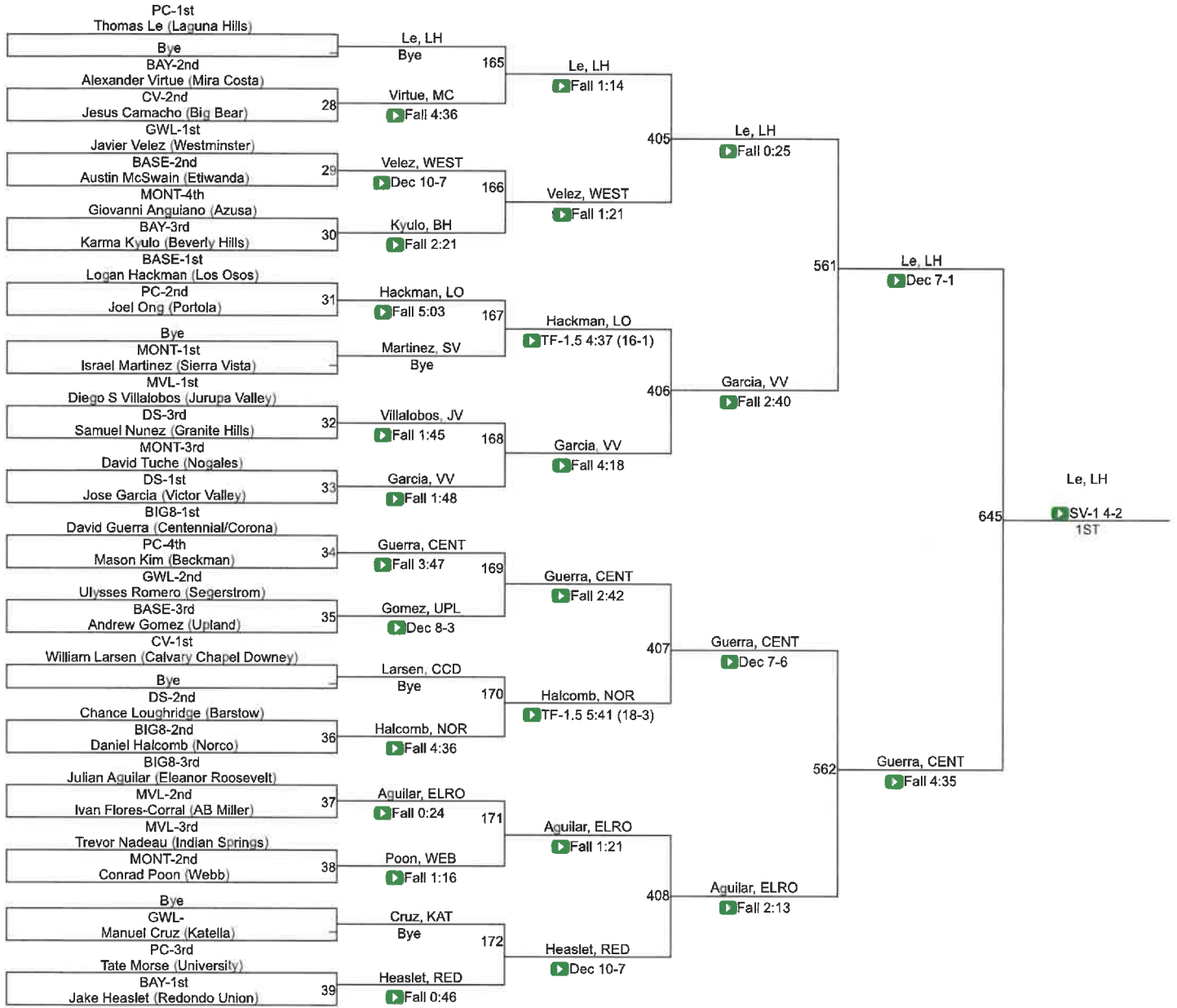

126

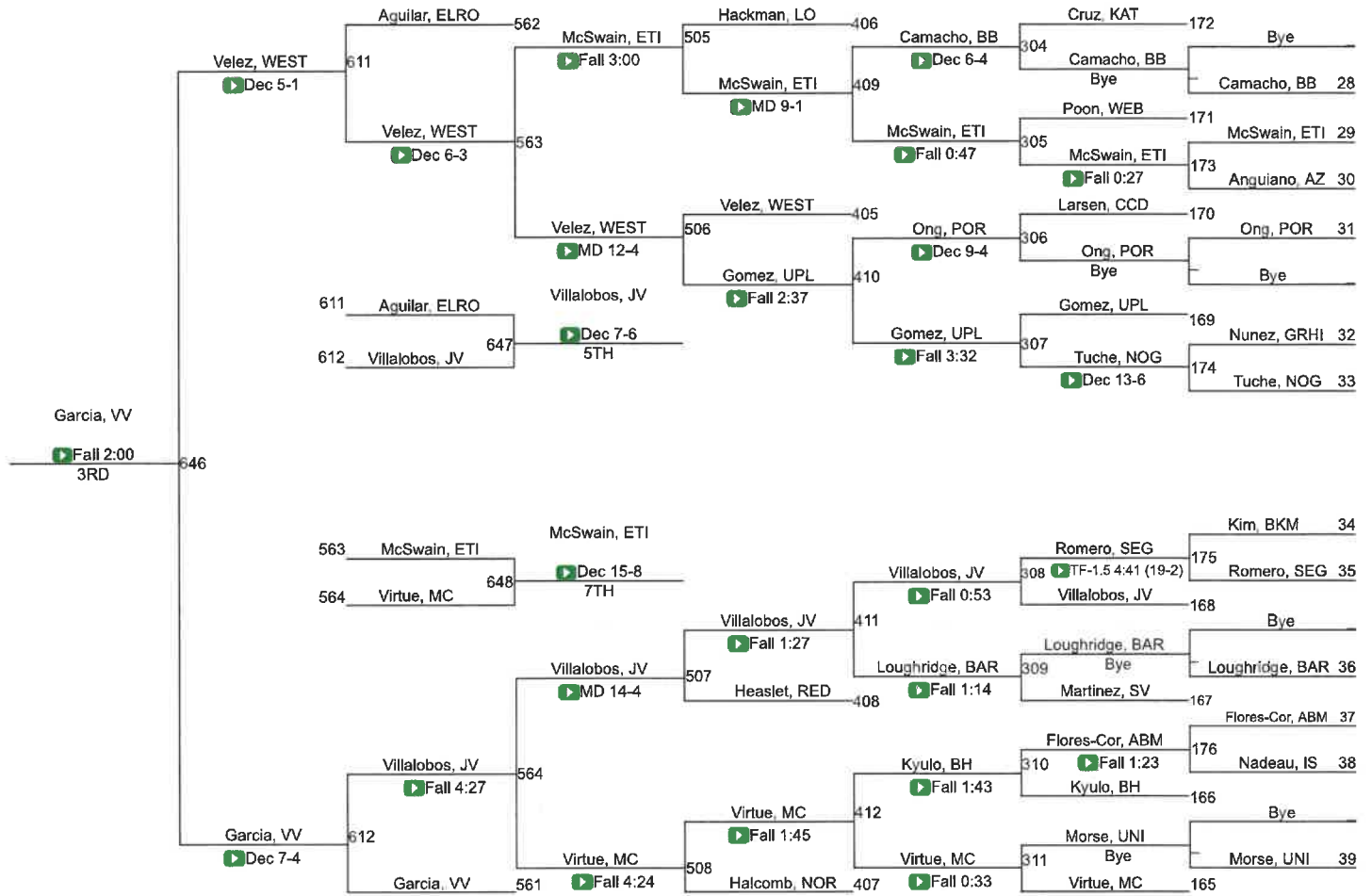

# 2022 CIF-SS Boys Individuals Coastal Division

132

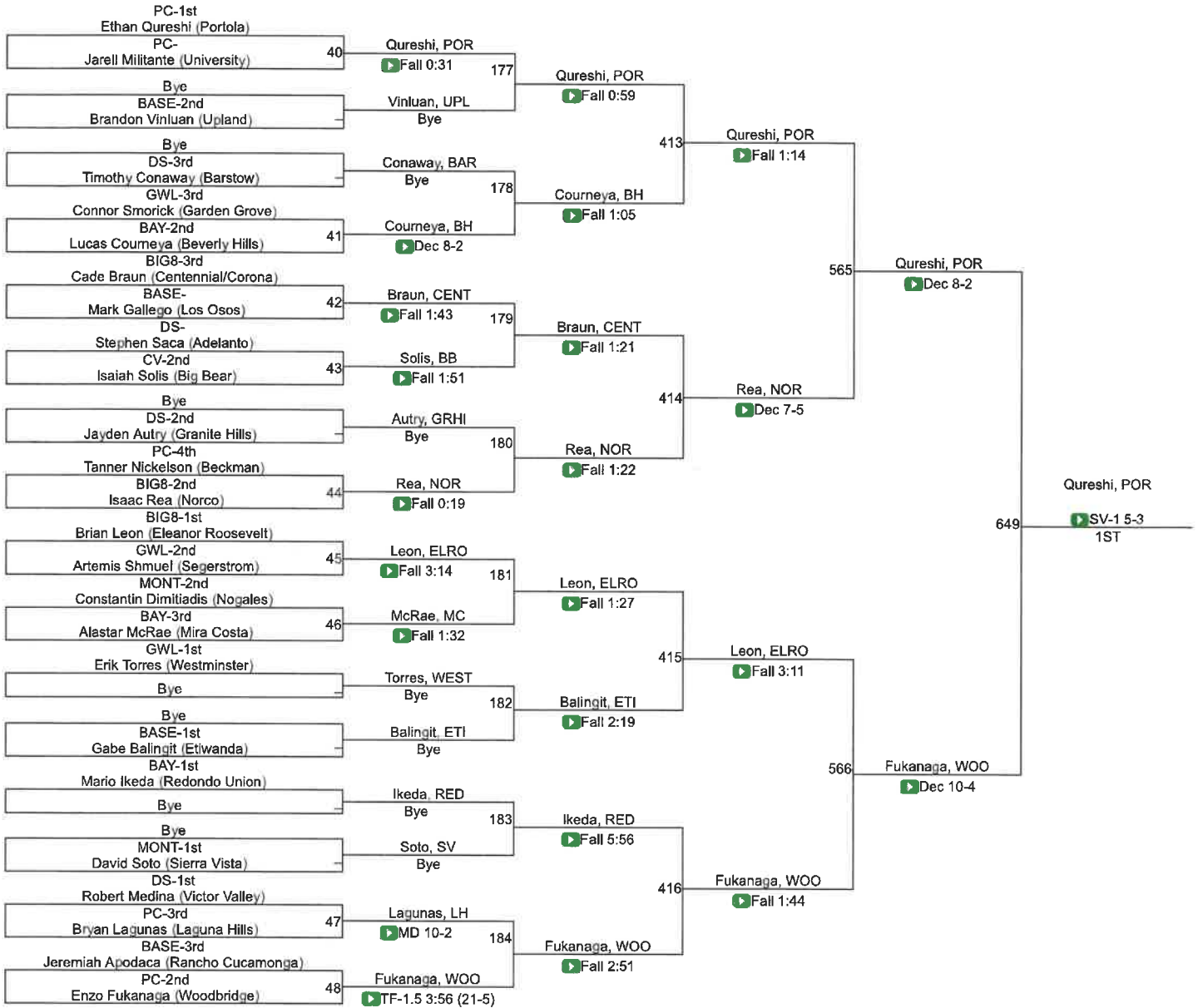

132

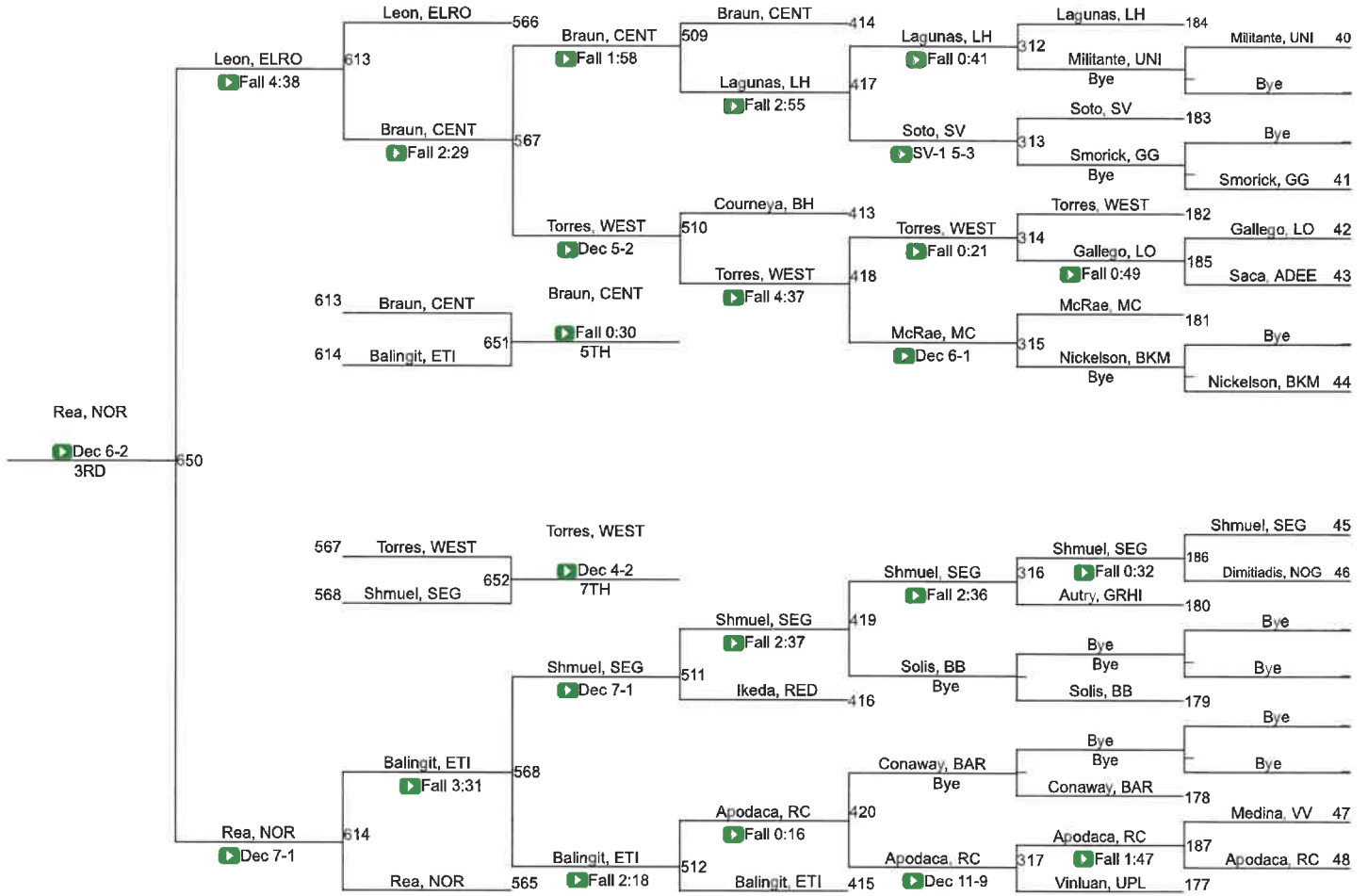

# 2022 CIF-SS Boys Individuals Coastal Division

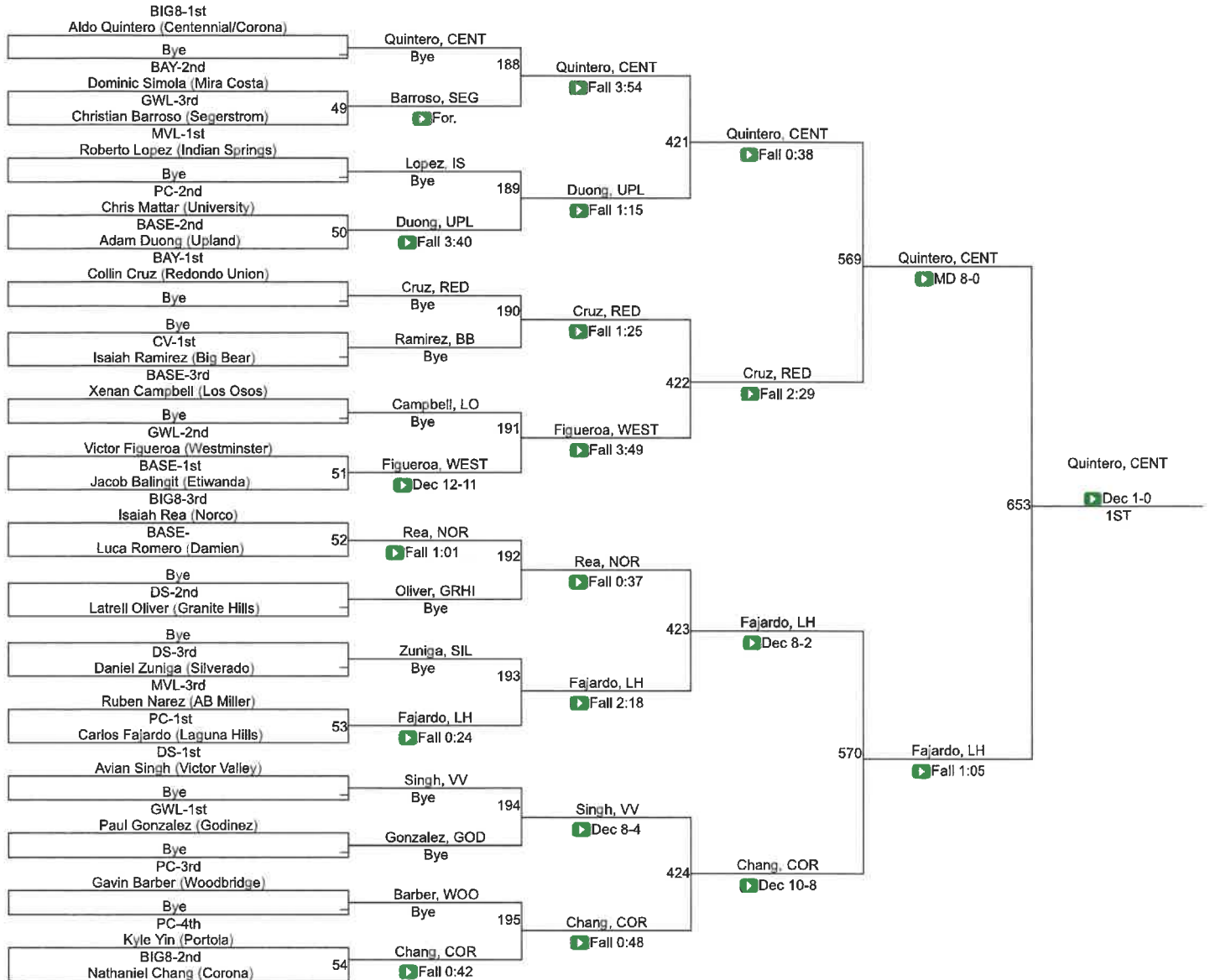

138

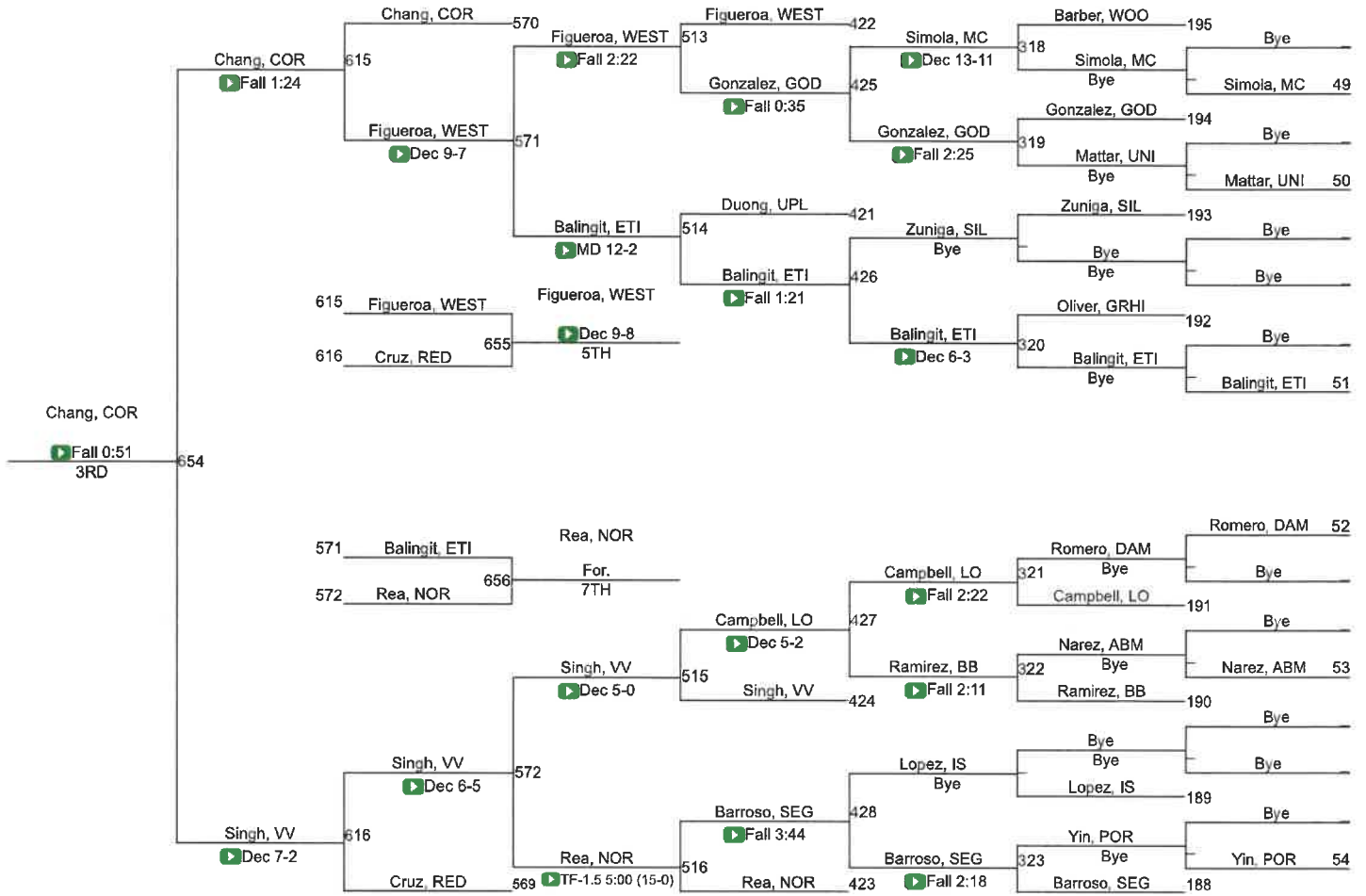



# 2022 CIF-SS Boys Individuals Coastal Division

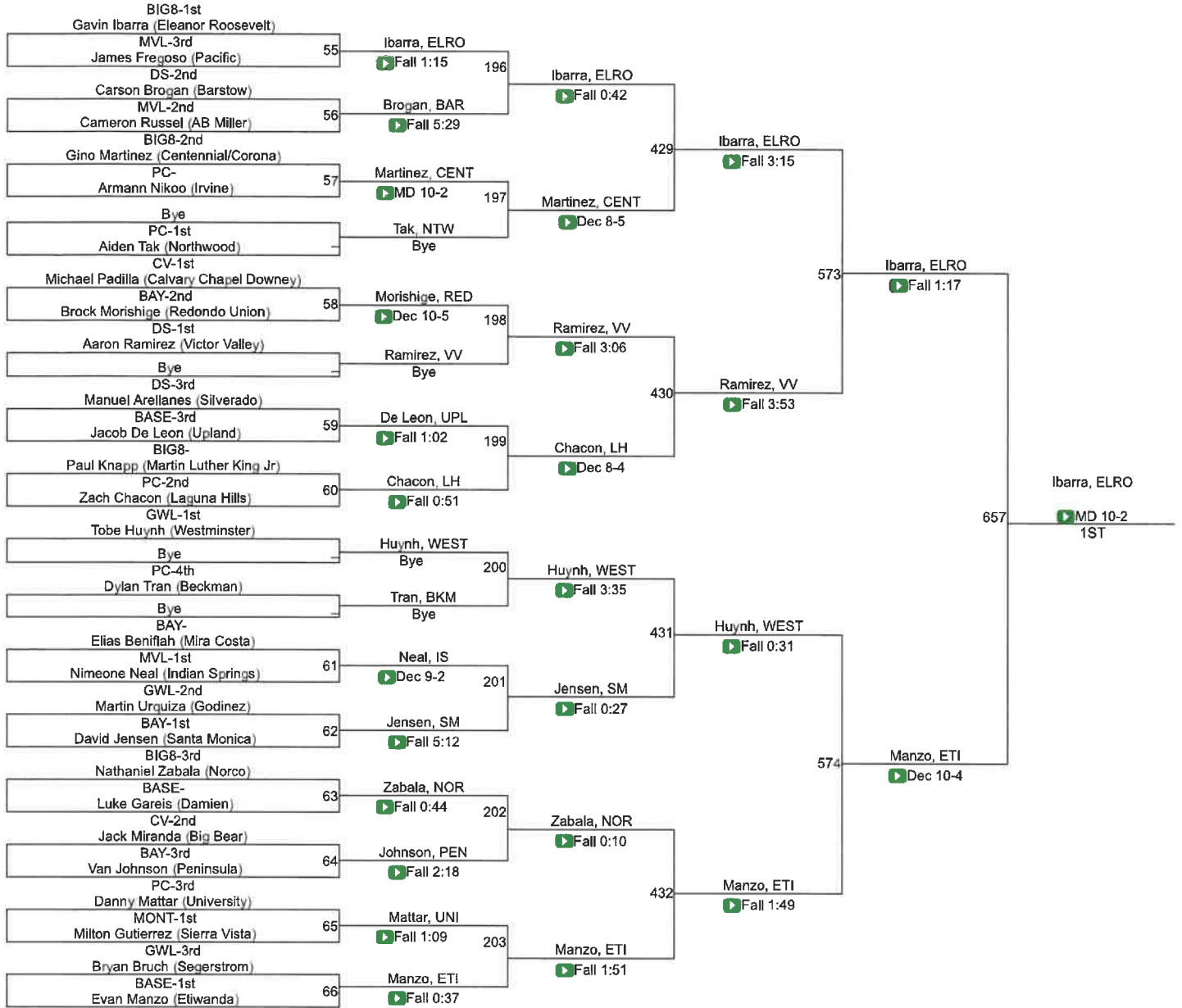

145

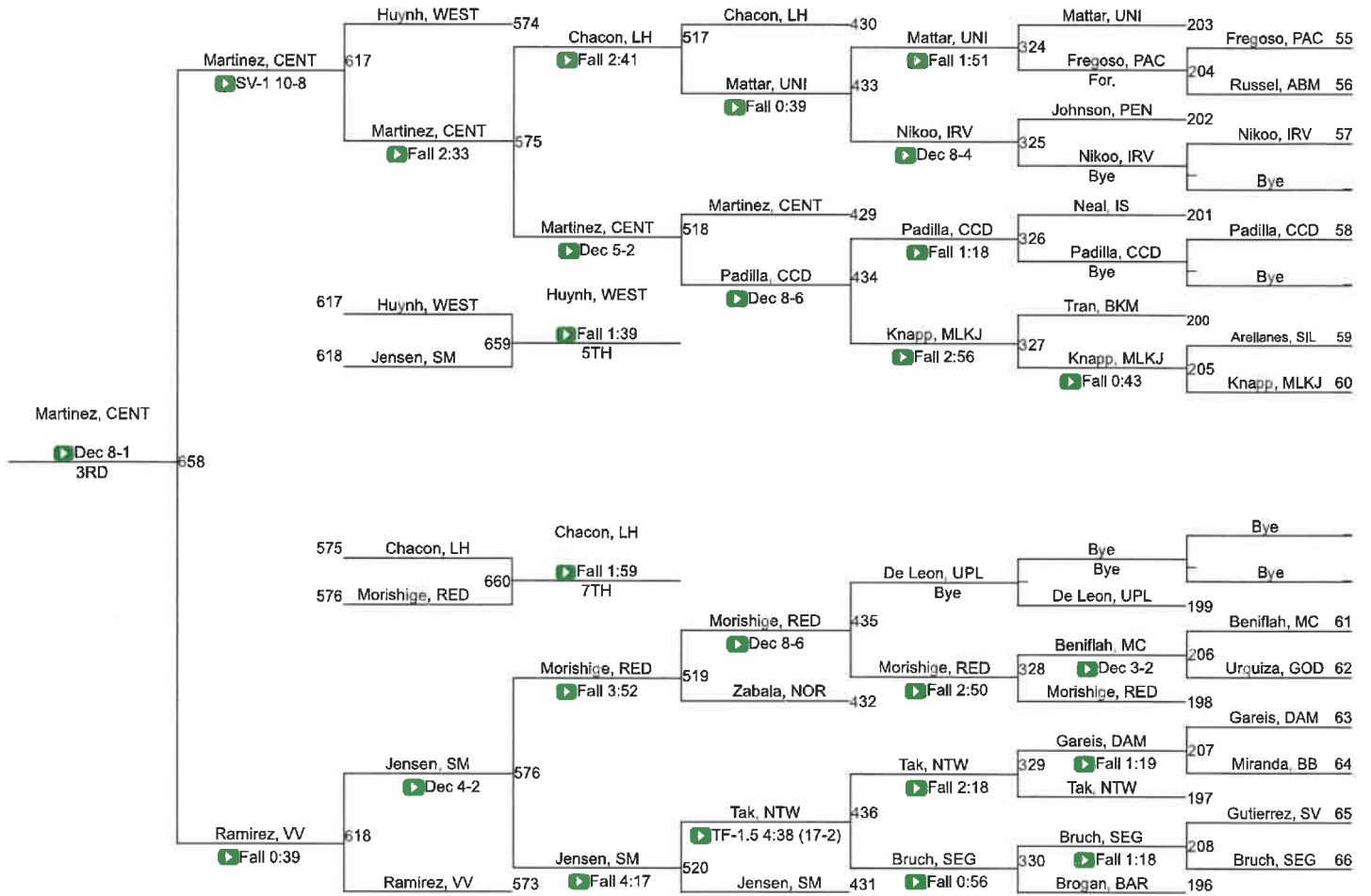

# 2022 CIF-SS Boys Individuals Coastal Division

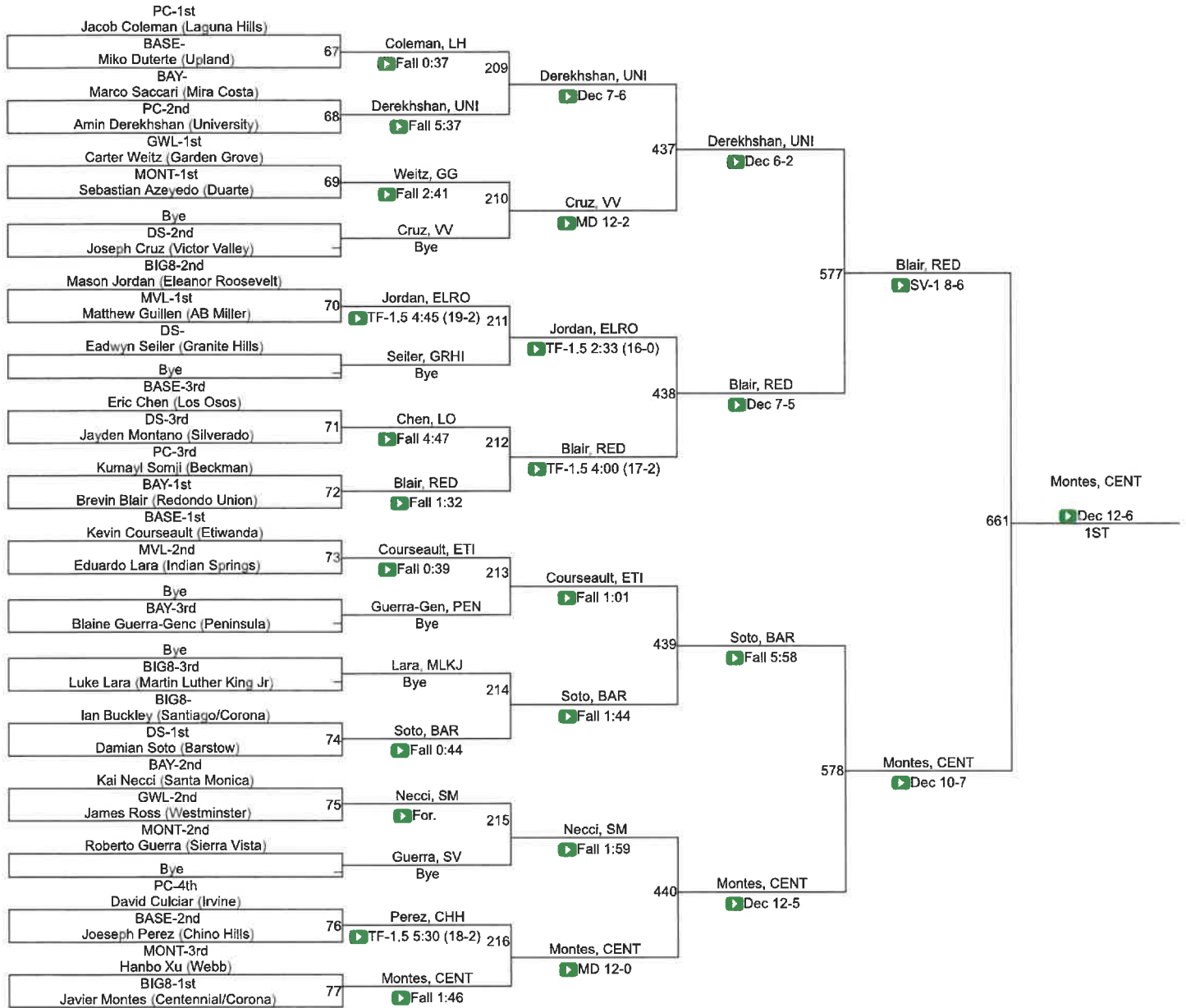

152

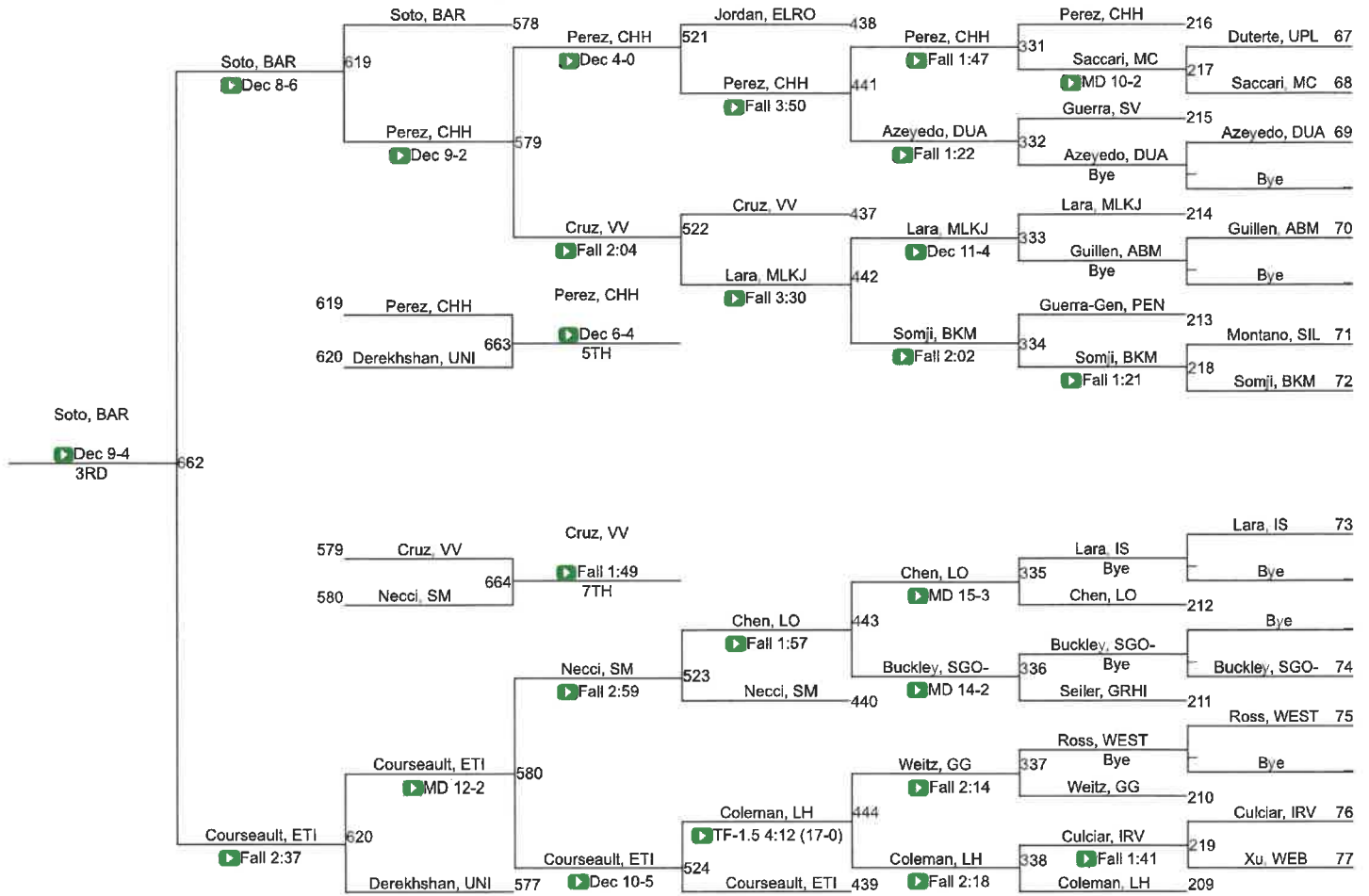

# 2022 CIF-SS Boys Individuals Coastal Division

160

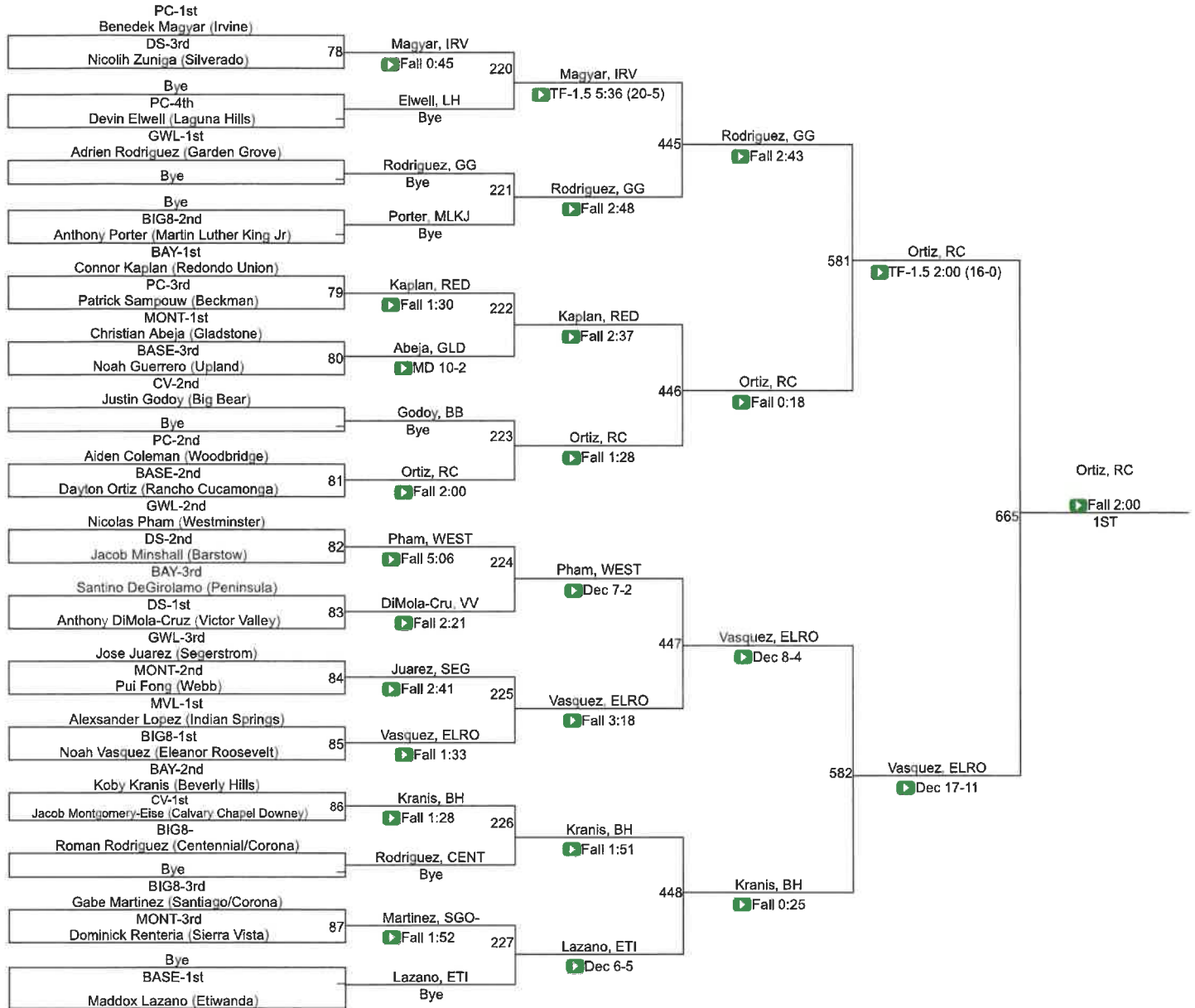



# 2022 CIF-SS Boys Individuals Coastal Division

170

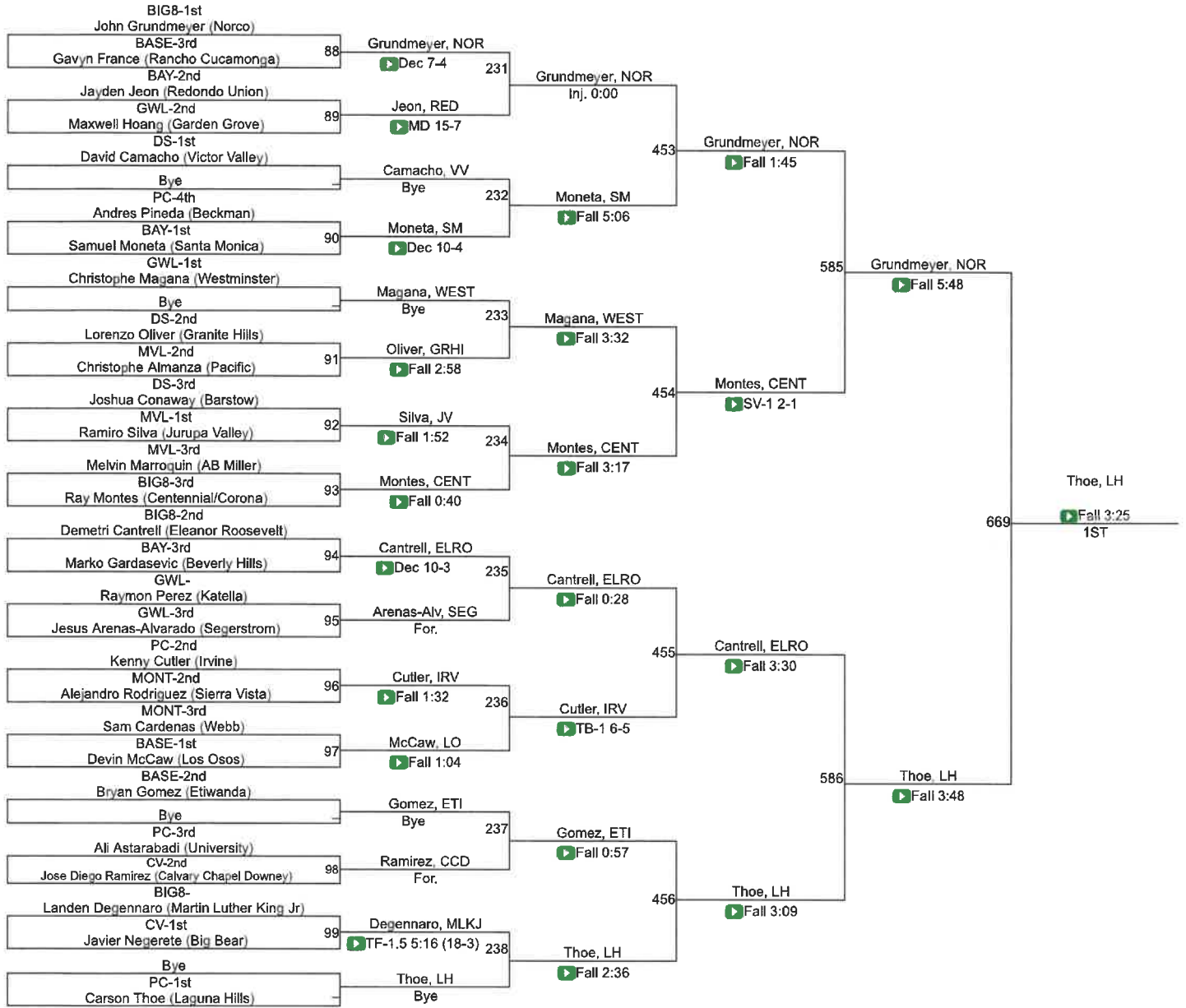



170

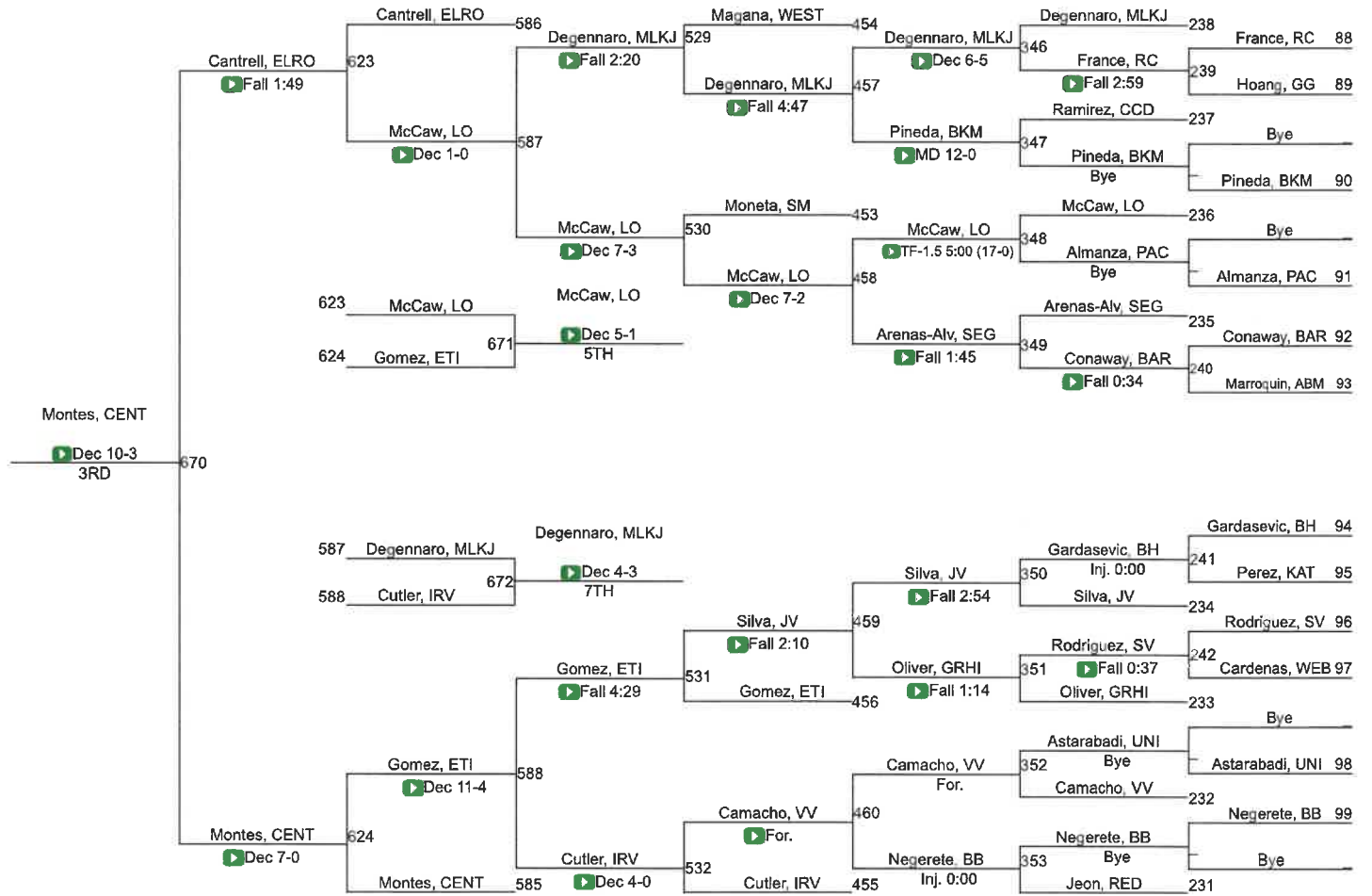

# 2022 CIF-SS Boys Individuals Coastal Division

182

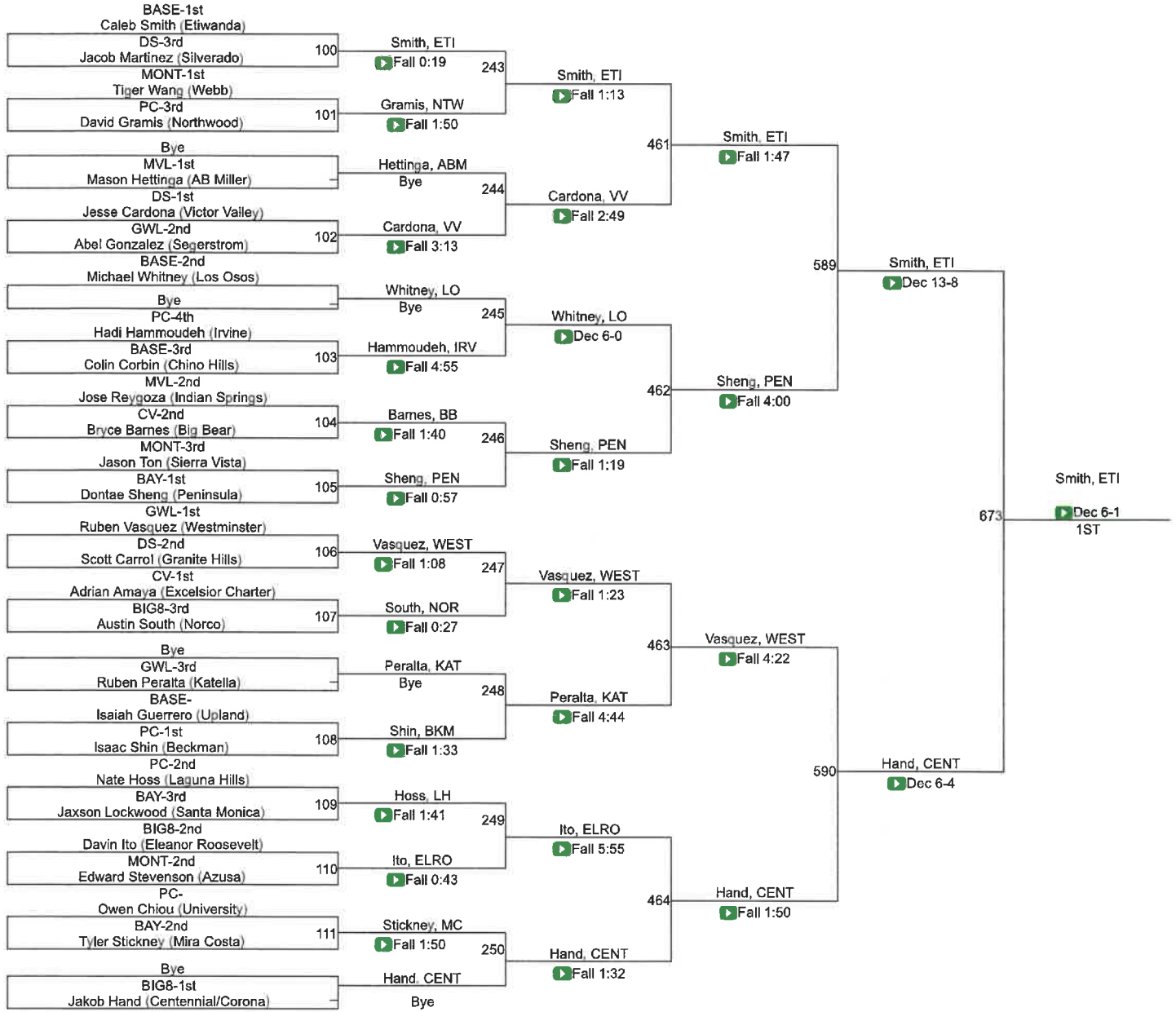

182

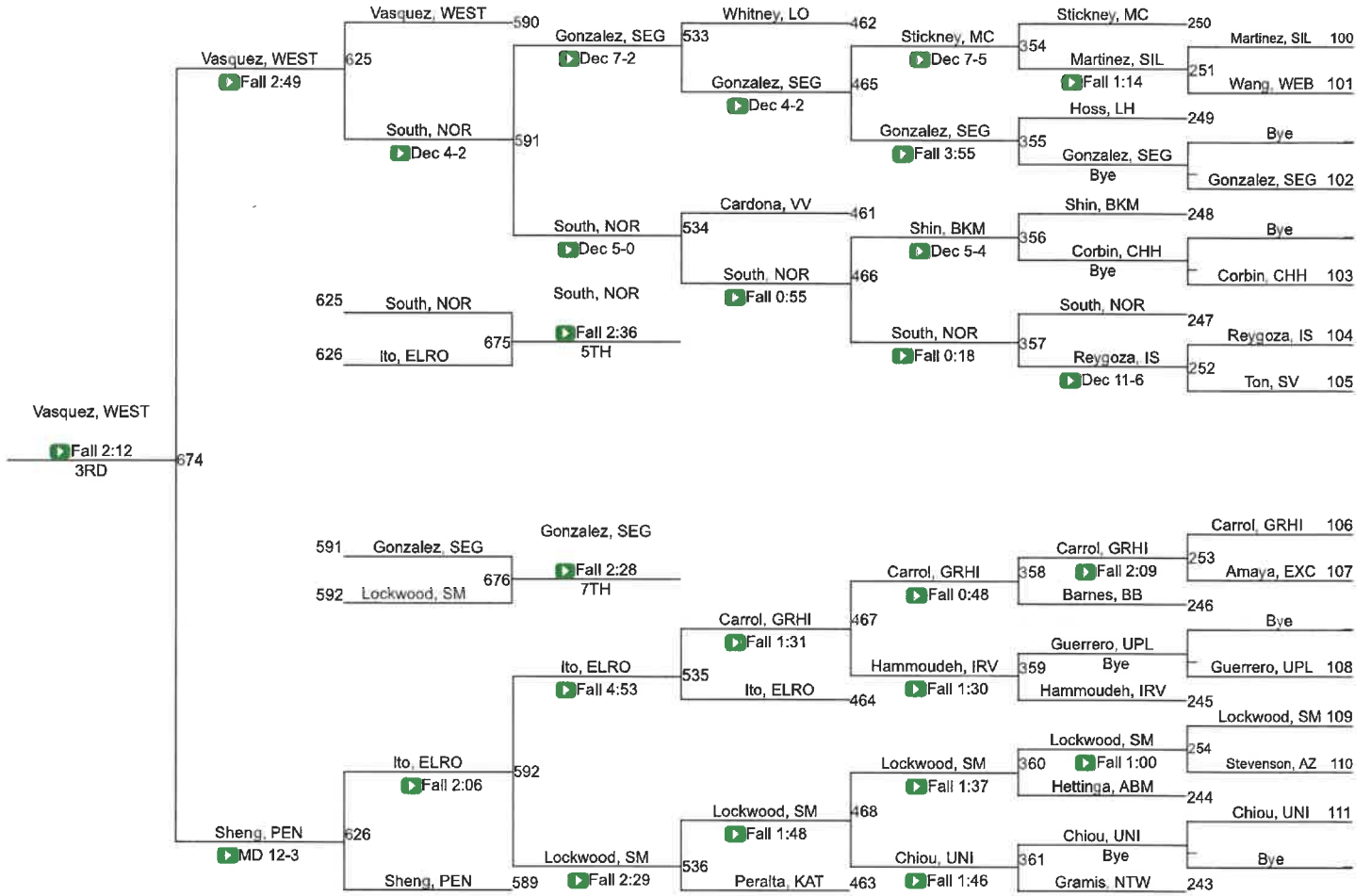

# 2022 CIF-SS Boys Individuals Coastal Division

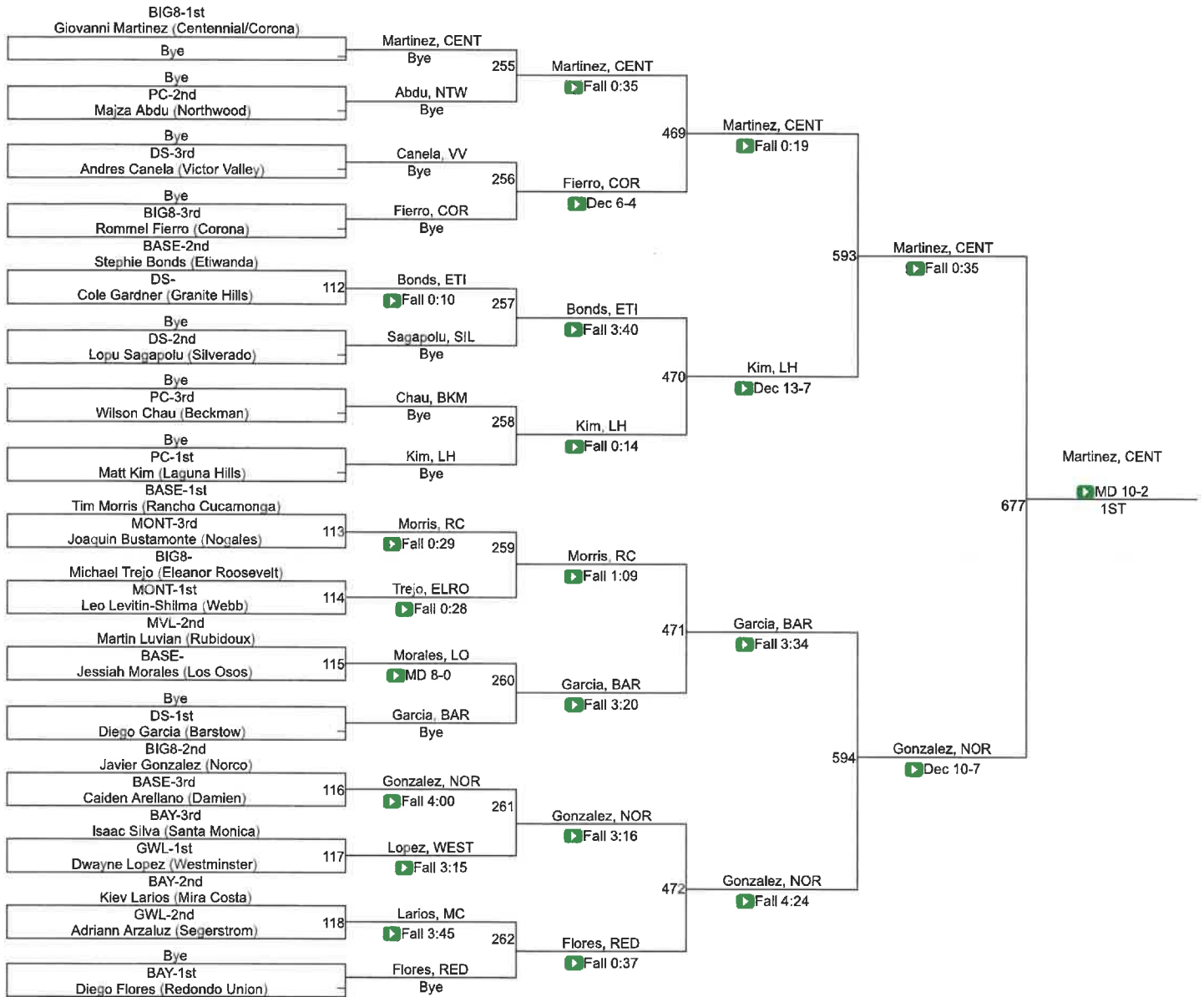

195

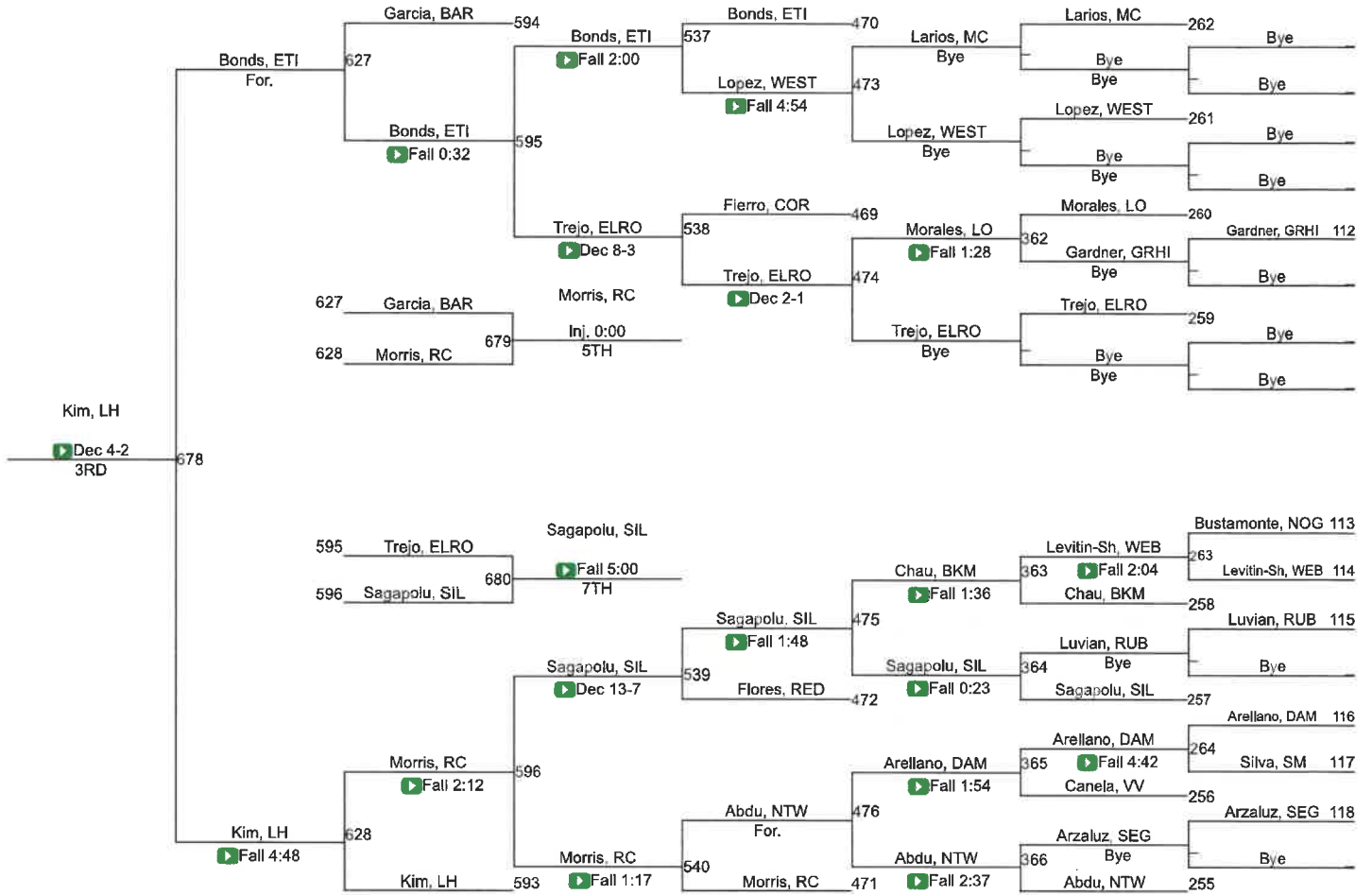

# 2022 CIF-SS Boys Individuals Coastal Division

220

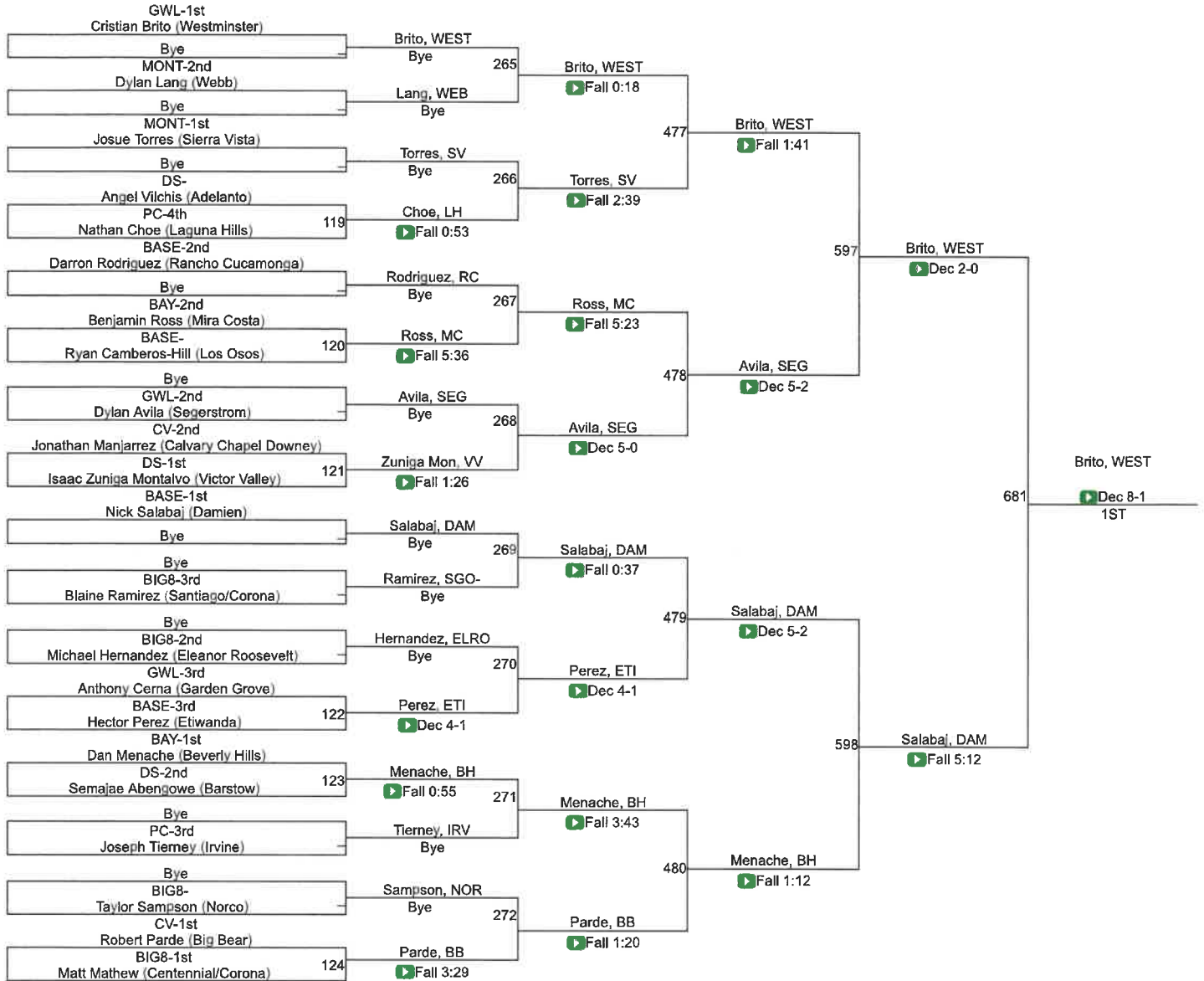

# 220

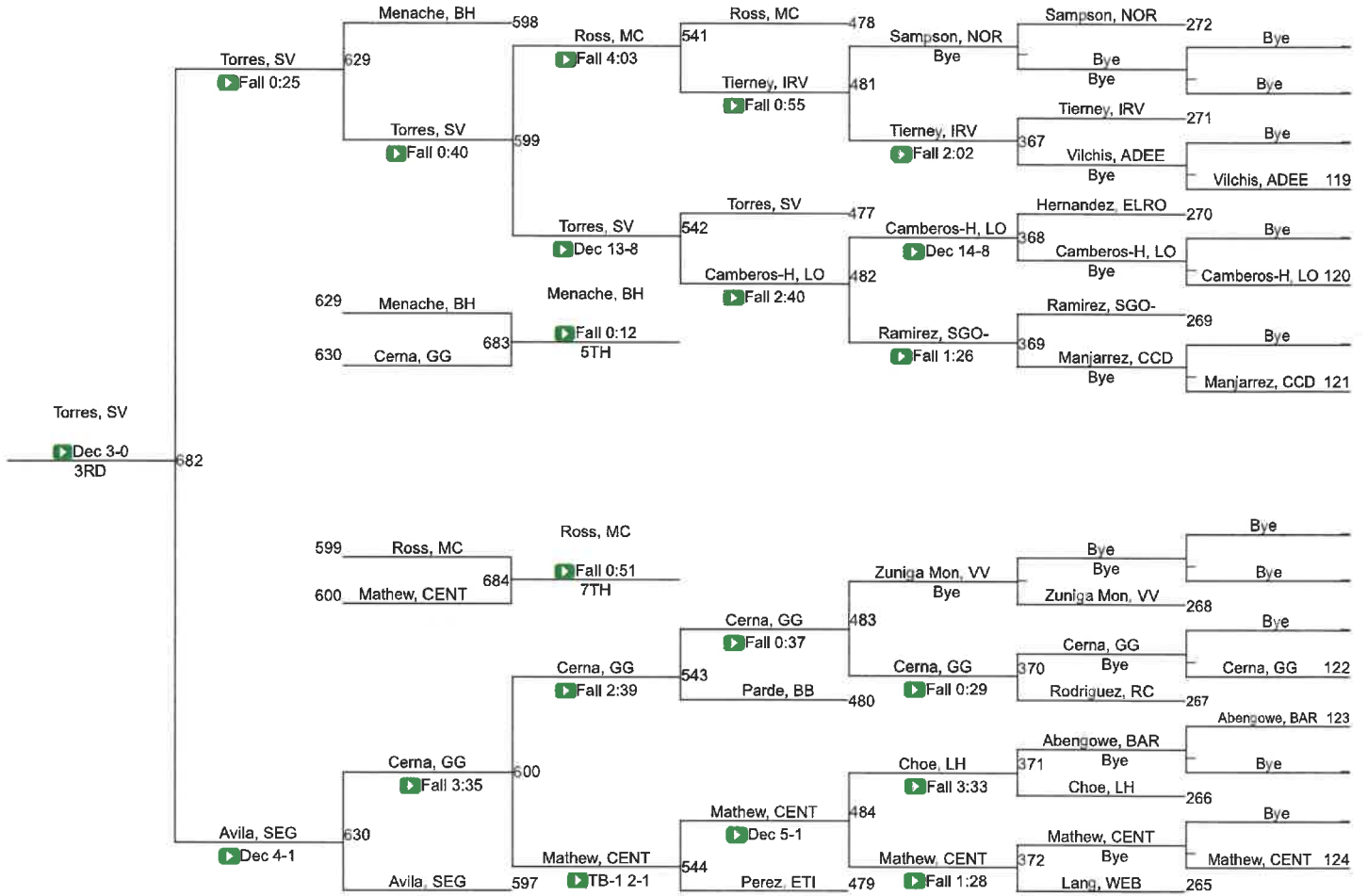



# 2022 CIF-SS Boys Individuals Coastal Division

285

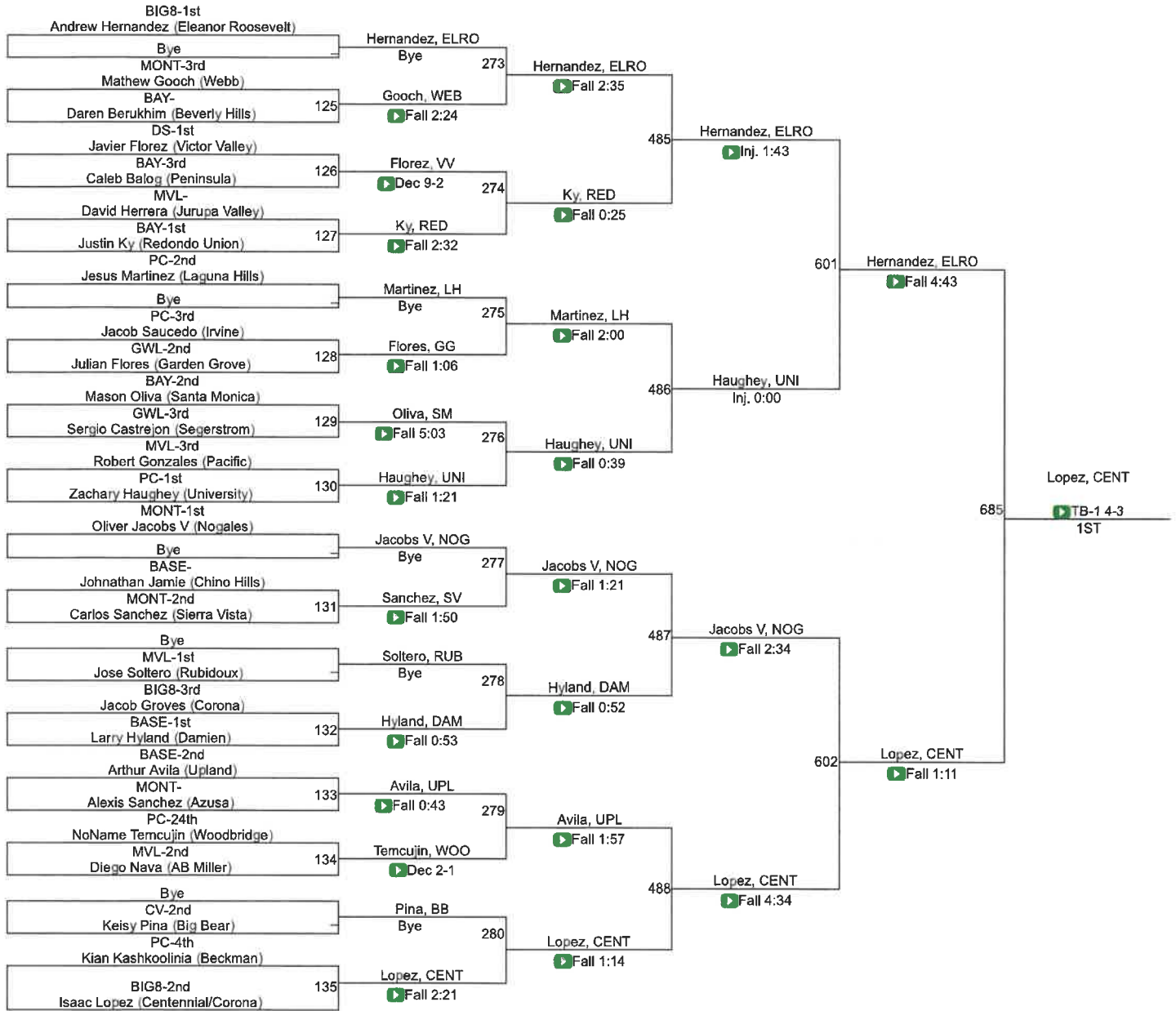

# 285

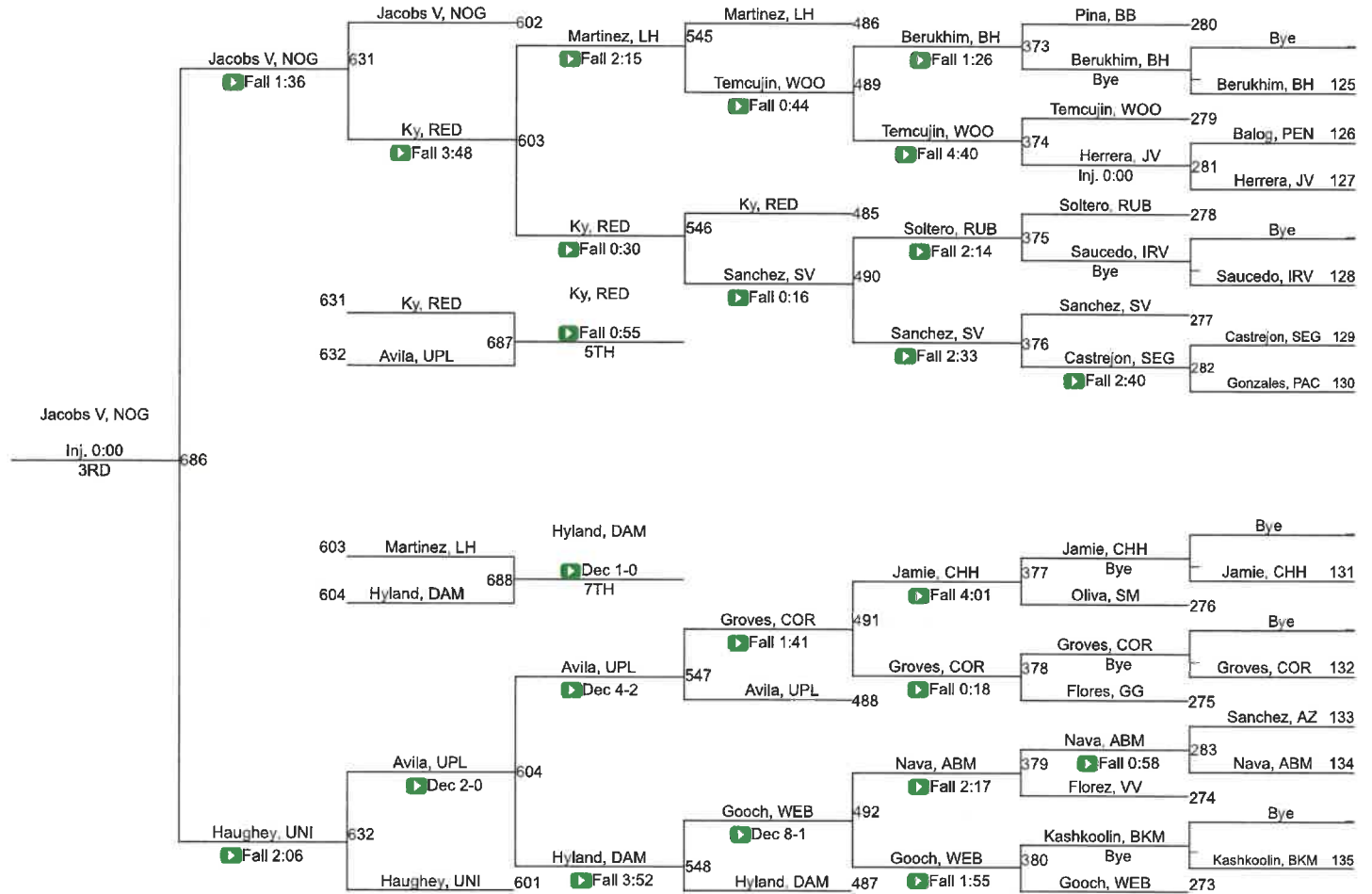

2022 CIF-SS FORD GIRLS SOCCER DIVISION 1 CHAMPIONSHIP

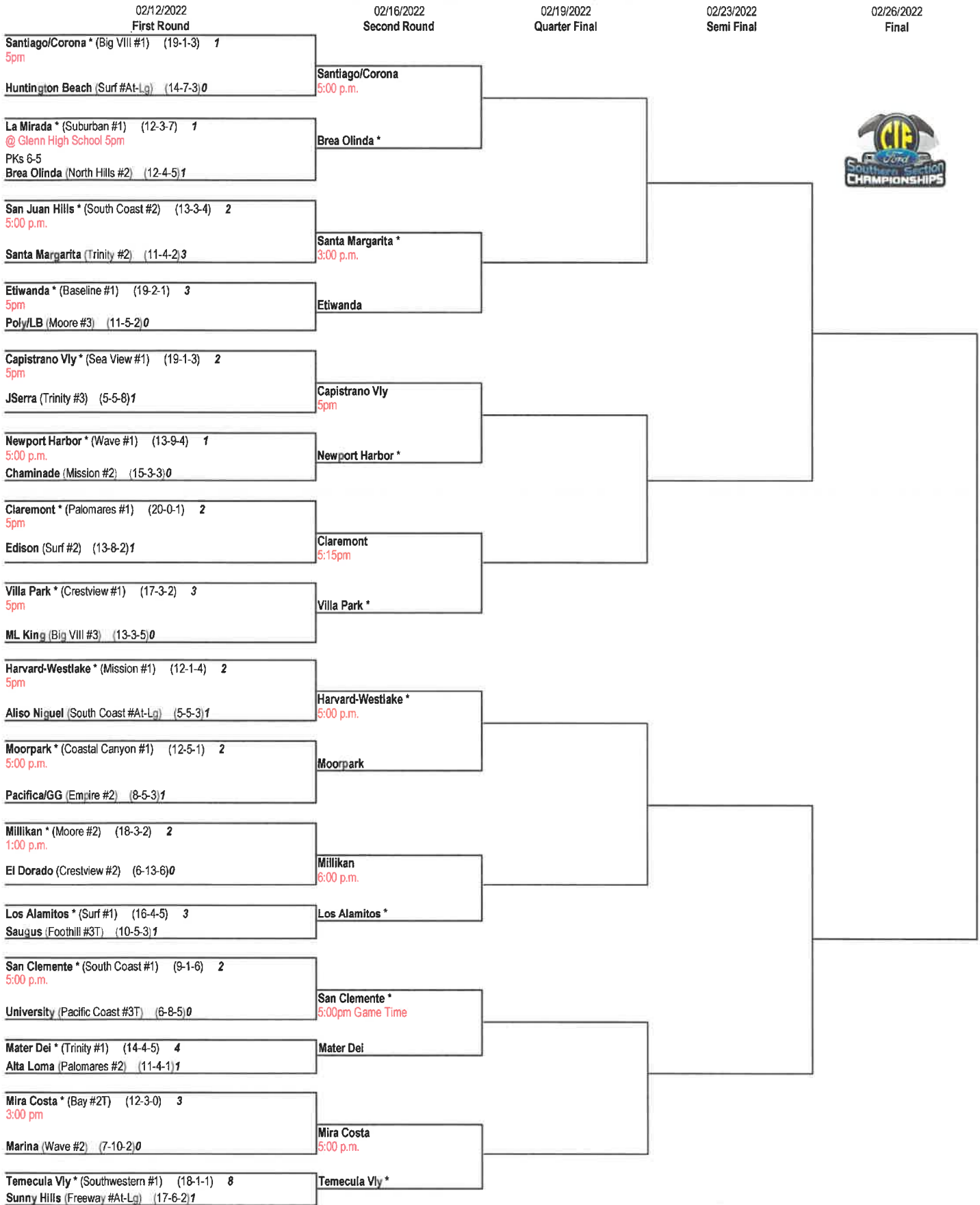

\*DENOTES HOST TEAM This draw sheet was made based upon information available to the CIF-SS as of 2/6/22. We reserve the right to adjust the draw sheet as a result of information which would update any final league standings. All playoff game times (except for the championship finals) are set for 3:00pm or 5:00pm. The HOME TEAM has the option of these two times based on availability of the field and/or if the field has

lights. If an alternate time is necessary mutual consent to the game time change is required by the two schools. All game times are to be confirmed between the opponents and then communicated to the Southern Section office and officials. Coin flips for the second round will be held in advance of the first-round games under the direction of the Commissioner on Friday, February 11, 2022. Pre-Flips for subsequent rounds will be available at [www.cifss.org](http://www.cifss.org) as follows: Quarterfinals on February 14 by 11:00am, Semifinals on February 17 by 11:00am, and Finals on February 21 by 11:00am. Please submit your scores immediately following the game at [CIFSSHOME.ORG](http://CIFSSHOME.ORG). PLEASE REPORT SCORES TO: CIF-SS OFFICE - [www.cifsshome.org](http://www.cifsshome.org); [www.scorebooklive.com](http://www.scorebooklive.com) or [www.maxpreps.com](http://www.maxpreps.com) and YOUR LOCAL NEWSPAPER. Draw results available on our website @ [www.cifss.org](http://www.cifss.org).

2022 CIF-SS FORD GIRLS SOCCER DIVISION 2 CHAMPIONSHIP

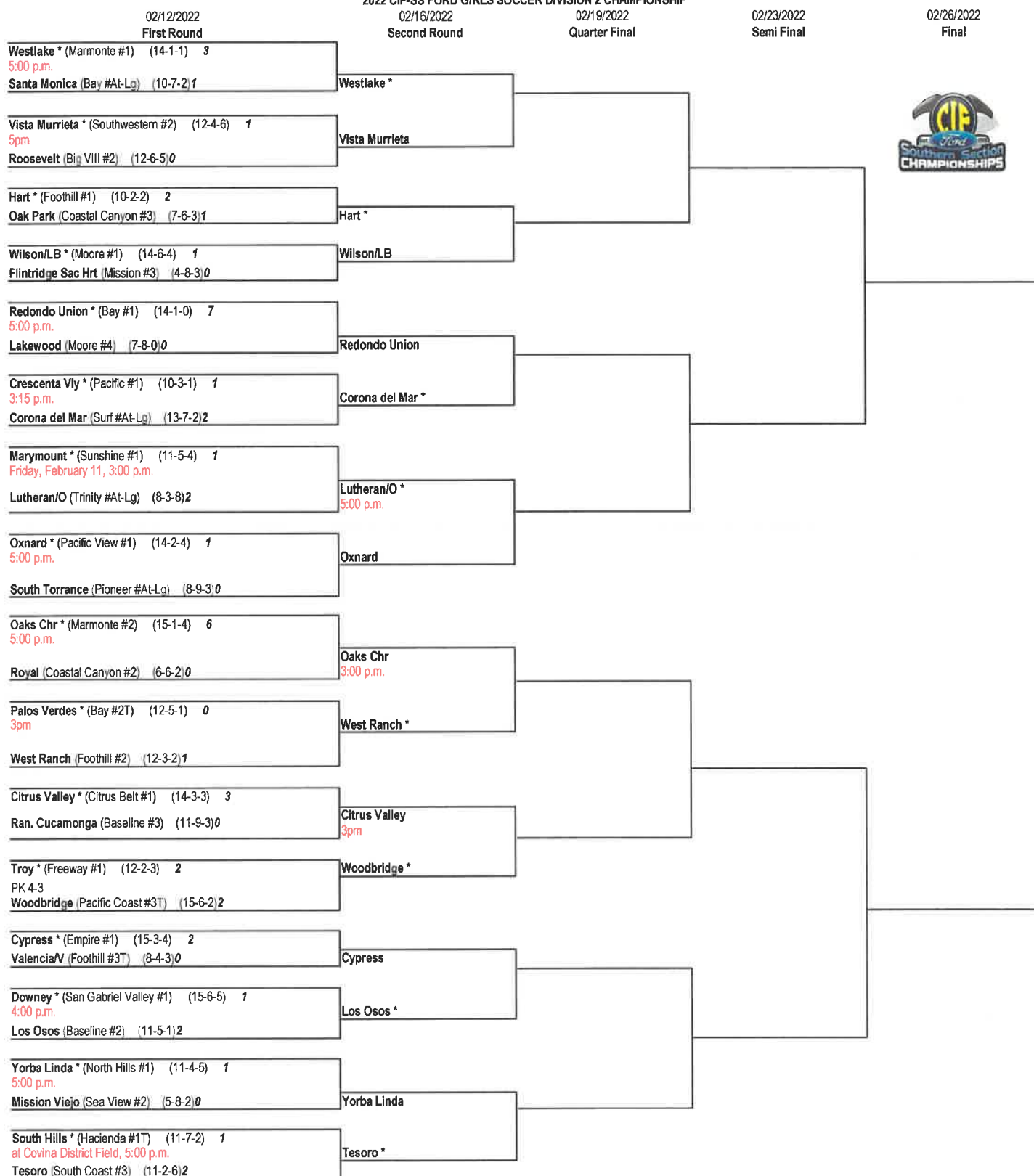

\*DENOTES HOST TEAM This draw sheet was made based upon information available to the CIF-SS as of 2/6/22. We reserve the right to adjust the draw sheet as a result of information which would update any final league standings. All playoff game times (except for the championship finals) are set for 3:00pm or 5:00pm. The HOME TEAM has the option of these two times based on availability of the field and/or if the field has lights. If an alternate time is necessary mutual consent to the game time change is required by the two schools. All game times are to be confirmed between the opponents and then communicated to the Southern Section office and officials. Coin flips for the second round will be held in advance of the first-round games under the direction of the Commissioner on Friday, February 11, 2022. Pre-Flips for subsequent rounds will be available at [www.cifss.org](http://www.cifss.org) as follows: Quarterfinals on February 14 by 11:00am, Semifinals on February 17 by 11:00am, and Finals on February 21 by 11:00am. Please submit your scores immediately following the game at [CIFSSHOME.ORG](http://CIFSSHOME.ORG). PLEASE REPORT SCORES TO: CIF-SS OFFICE - [www.cifsshome.org](http://www.cifsshome.org); [www.scorebooklive.com](http://www.scorebooklive.com) or [www.maxpreps.com](http://www.maxpreps.com) and YOUR LOCAL NEWSPAPER. Draw results available on our website @ [www.cifss.org](http://www.cifss.org).

# CIF SS Boys Individuals-Eastern Division

## Temecula Valley High School

February 11-12, 2022



### Lower Weight Outstanding Wrestler

Aidan Munoz  
Temecula Valley HS  
113 Pounds

### Upper Weight Outstanding Wrestler

Hector Haro  
Cathedral City HS  
220 Pounds

Placers			152 Pounds			Team Score Final		
<b>106 Pounds</b>			<b>152 Pounds</b>			1	Temecula Valley	374
1st	Kyle Baldonado	Temecula Valley	1st	Mark Takara	Temecula Valley	2	Calvary Chapel (Santa Ana)	301
2nd	Jimmy Romero	Cypress	2nd	Devyn Che	Calvary Chapel (Santa Ana)	3	San Clemente	184.5
3rd	Brandon Ryan	Murrieta Valley	3rd	Billy Dean	Tesoro	4	Trabuco Hills	137.5
4th	Joseph Zuniga	Trabuco Hills	4th	Luciano Benenati	Aliso Niguel	5	Cypress	134
5th	Santino Nonaca	San Clemente	5th	Tyler Thienngern	Cypress	6	Chaparral	124
6th	Issac Rodriguez	Tahquitz	6th	Jason Escalante	Santa Ana	7	Aliso Niguel	119.5
7th	Ahad Sohail	Capistrano Valley H S	7th	Matt Valdez	San Clemente	8	Tesoro	115
8th	ERNIE VIGIL	Pioneer (Whittier)	8th	Tyler Aughenbaugh	Chaparral	9	Capistrano Valley H S	112
<b>113 Pounds</b>			<b>160 Pounds</b>			10	Cathedral City	92.5
1st	Aidan Munoz	Temecula Valley	1st	Manuel Gaitan	Temecula Valley	11	West Valley (Hemet)	79
2nd	Dylan Stark	Cypress	2nd	Luke Gayer	Calvary Chapel (Santa Ana)	12	Cerritos	75.5
3rd	Milkey Ladkani	Tesoro	3rd	Nathan Nichols	Aliso Niguel	13	Santa Ana	73.5
4th	Diego Garcia Perez	Trabuco Hills	4th	Vance Frabasilio	San Clemente	14	Vista Murrieta	67.5
5th	James Gauntlett	San Jacinto	5th	Victor Rodarte	Tesoro	15	Murrieta Valley	51
6th	JANG HAYDEN	Cerritos	6th	EMILIO CEJA	Cerritos	16	Costa Mesa	50
7th	Logan Rubio	Tustin	7th	Adam Cintron	Murrieta Mesa	17	Great Oak	49
8th	Lazaro Lopez	Santa Ana	8th	Gabriel Flores	Cathedral City	17	Murrieta Mesa	49
<b>120 Pounds</b>			<b>170 Pounds</b>			19	Estancia	46
1st	Ethan Perryman	Temecula Valley	1st	Evan Gilbert	Calvary Chapel (Santa Ana)	20	Valencia (Placentia)	45
2nd	Allan Hendricks	Calvary Chapel (Santa Ana)	2nd	Matt York	Temecula Valley	21	Heritage (Romoland)	44
3rd	Russell Wang	Capistrano Valley H S	3rd	Michael McGettigan	Tesoro	22	Tustin	43.5
4th	CHRIS ESPINOZA	Cerritos	4th	Juan Segura	Capistrano Valley H S	23	Coachella Valley	38
5th	Onelo Lorberter	Chaparral	5th	Indiana Fightmaster	San Clemente	24	El Toro	35
6th	Dane Curran	Costa Mesa	6th	Farid Sawaya	Valencia (Placentia)	24	Indio	35
7th	Andrew Lopez	Cypress	7th	Logan Witten	Trabuco Hills	26	John Glenn	34
8th	Trent Fricke	El Toro	8th	KOEN BLANK	Great Oak	27	Mission Viejo	28.5
<b>126 Pounds</b>			<b>182 Pounds</b>			28	Desert Hot Springs	28
1st	Yoshiya Funakoshi	Calvary Chapel (Santa Ana)	1st	Isaiah Morales	Cathedral City	28	San Jacinto	28
2nd	Nathan Perryman	Temecula Valley	2nd	Nico Turturo	Temecula Valley	28	San Jacinto	28
3rd	Justin Herrera	Chaparral	3rd	Victor Franklin	Vista Murrieta	30	Citrus Hill	26
4th	Isaac Mendoza	El Toro	4th	Daniel Dominguez	Mission Viejo	31	Notre Dame (Riverside)	25
5th	Vincenzo Benenati	Aliso Niguel	5th	Ray Gulmatico	Calvary Chapel (Santa Ana)	31	Valley View Hs	25
6th	Matthew Catalano	Vista Murrieta	6th	George Lewis	West Valley (Hemet)	33	Tahquitz	22
7th	Craig Phoenix	Capistrano Valley H S	7th	Robert Maley	San Clemente	34	Artesia	21
8th	Isaac Deloa-Romero	Citrus Hill	8th	Benjamin Setum	Pacifica (Garden Grove)	35	Dana Hills	20
<b>132 Pounds</b>			<b>195 Pounds</b>			35	Pioneer (Whittier)	20
1st	Devin Avedissian	Temecula Valley	1st	Jetro Preciado	Calvary Chapel (Santa Ana)	37	Pacifica (Garden Grove)	17
2nd	Joaquin Arroyo	Calvary Chapel (Santa Ana)	2nd	Cole Robertson	San Clemente	38	John F Kennedy	15
3rd	Benjamin Hernandez	San Clemente	3rd	Marcelo Juarez Aparici	Santa Ana	39	Orange	14
4th	Trevor Wagstaff	Estancia	4th	Matt Porras Diamond	Temecula Valley	40	Pomona	13
5th	Gabriel Canela	Chaparral	5th	Jacob Follero	Tesoro	41	Yuca Valley	11
6th	Robert Harris	Aliso Niguel	6th	Frye Zeke	Murrieta Valley	42	Perris	10
7th	Eli Kruger	Cypress	7th	Mauro Corona	Coachella Valley	43	Desert Mirage	8
8th	Daniel Altimirano	John Glenn	8th	Noah Bode	Vista Murrieta	44	Orange Vista	6
<b>138 Pounds</b>			<b>220 Pounds</b>			44	Santiago (Garden Grove)	6
1st	Jack Estevez	Calvary Chapel (Santa Ana)	1st	Hector Haro	Cathedral City	46	La Puente	4
2nd	Abel Gaitan	Temecula Valley	2nd	Caleb Madrid	Temecula Valley	47	Bassett	0
3rd	Zach Maxwell	Estancia	3rd	Tyler Redfield	Calvary Chapel (Santa Ana)	47	Edgewood	0
4th	Andrew Asbury	Trabuco Hills	4th	Vaughn Taylor	Chaparral	47	Ganesh	0
5th	Dominic Morales	San Clemente	5th	Fernando Llanos	San Clemente			
6th	Eduardo Espinoza	West Valley (Hemet)	6th	David Calix	Costa Mesa			
7th	Daniel Kington	Aliso Niguel	7th	Peter Solis	Notre Dame (Riverside)			
8th	Jessie Martinez	Tustin	8th	Alex Marquez	Aliso Niguel			
<b>145 Pounds</b>			<b>285 Pounds</b>					
1st	Alec Peralta	Temecula Valley	1st	Luke Meyer	Capistrano Valley H S			
2nd	Koa Ruiz	Calvary Chapel (Santa Ana)	2nd	Henry Sturm	Trabuco Hills			
3rd	Garrett Boyd	San Clemente	3rd	Dib Sawaya	Valencia (Placentia)			
4th	Jon Paino	Chaparral	4th	Aaron Jones	West Valley (Hemet)			
5th	Noah Zuniga	Trabuco Hills	5th	STEVEN WHELEN	Great Oak			
6th	Cameron Glabb	Costa Mesa	6th	Raul Mejia	Santa Ana			
7th	Jorge Gonzalez	Capistrano Valley H S	7th	SALVADOR BUENABA	Pioneer (Whittier)			
8th	Aiden Smiley	Heritage (Romoland)	8th	Travis Bodholdt	Cypress			





# 106

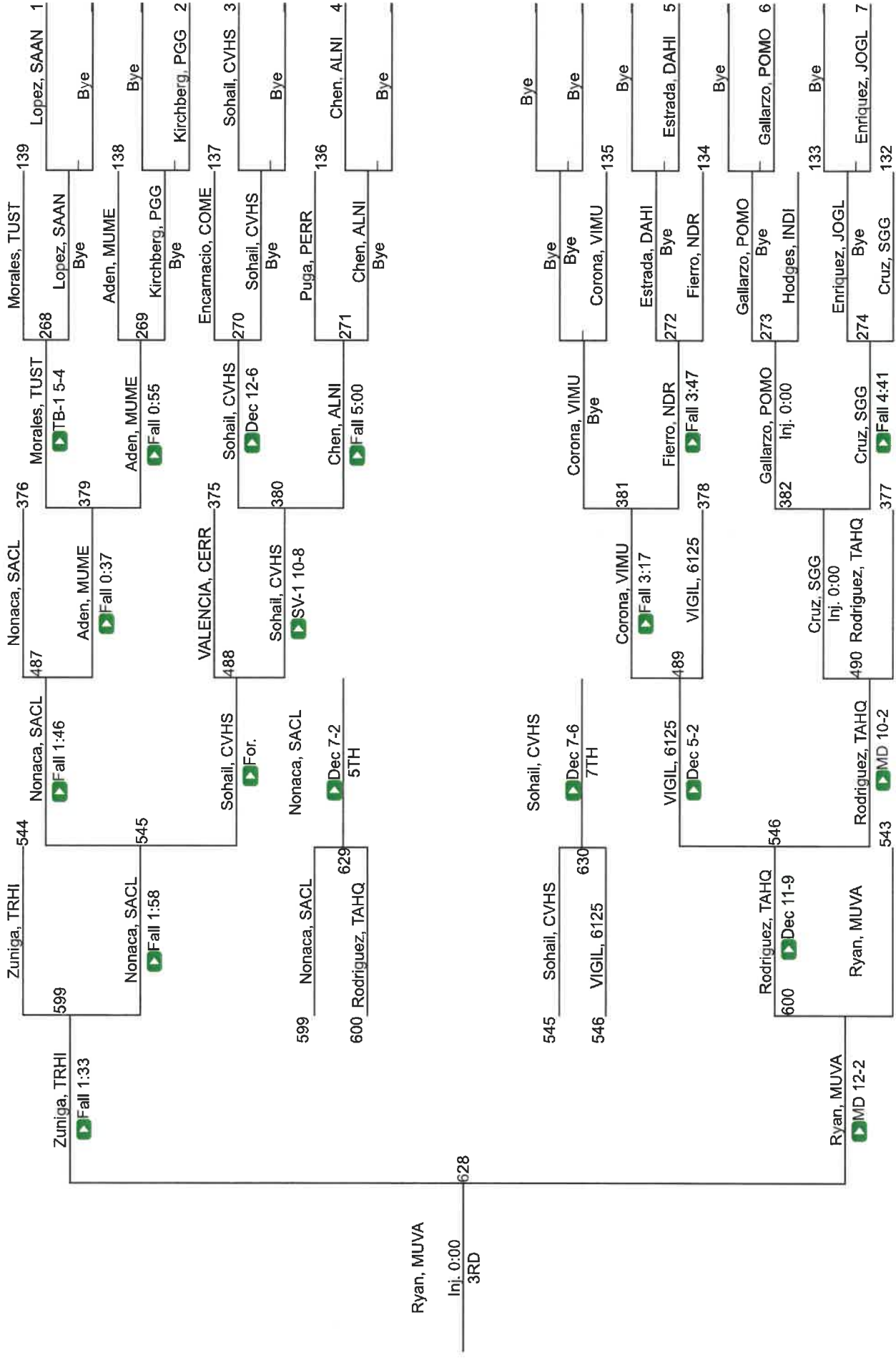























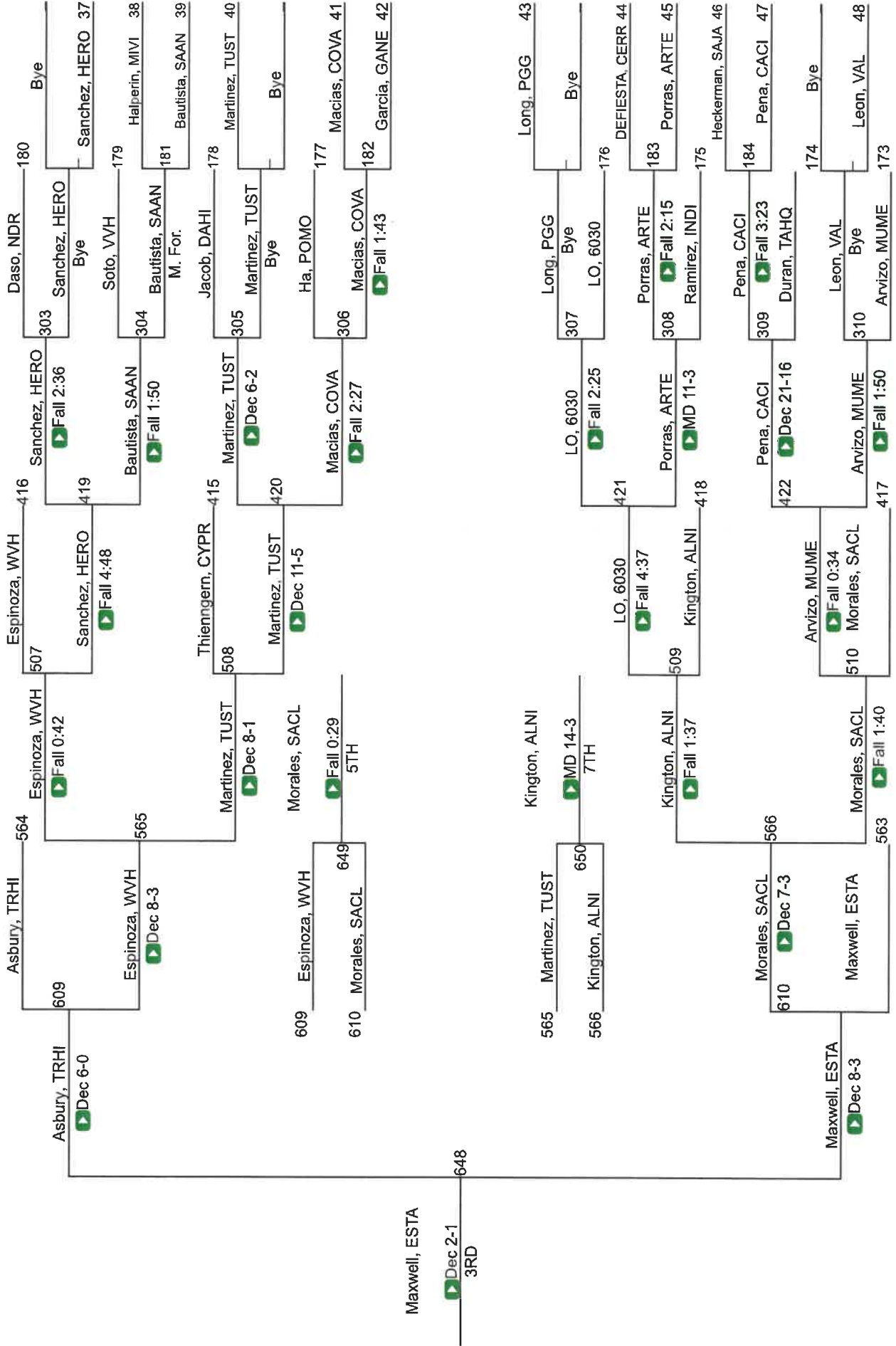



# 145

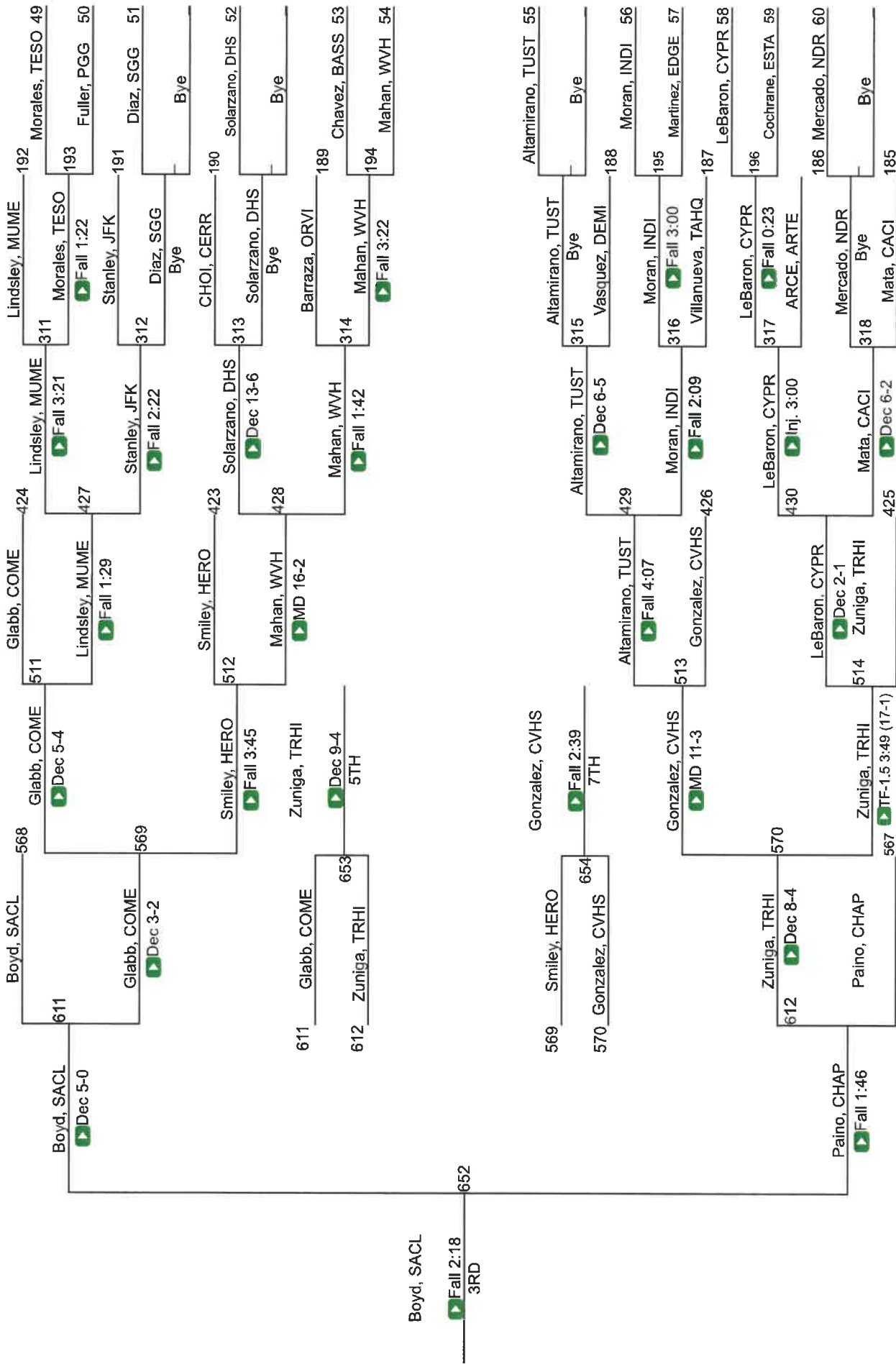

























# 2022 CIF-SS Boys Individuals Eastern Division

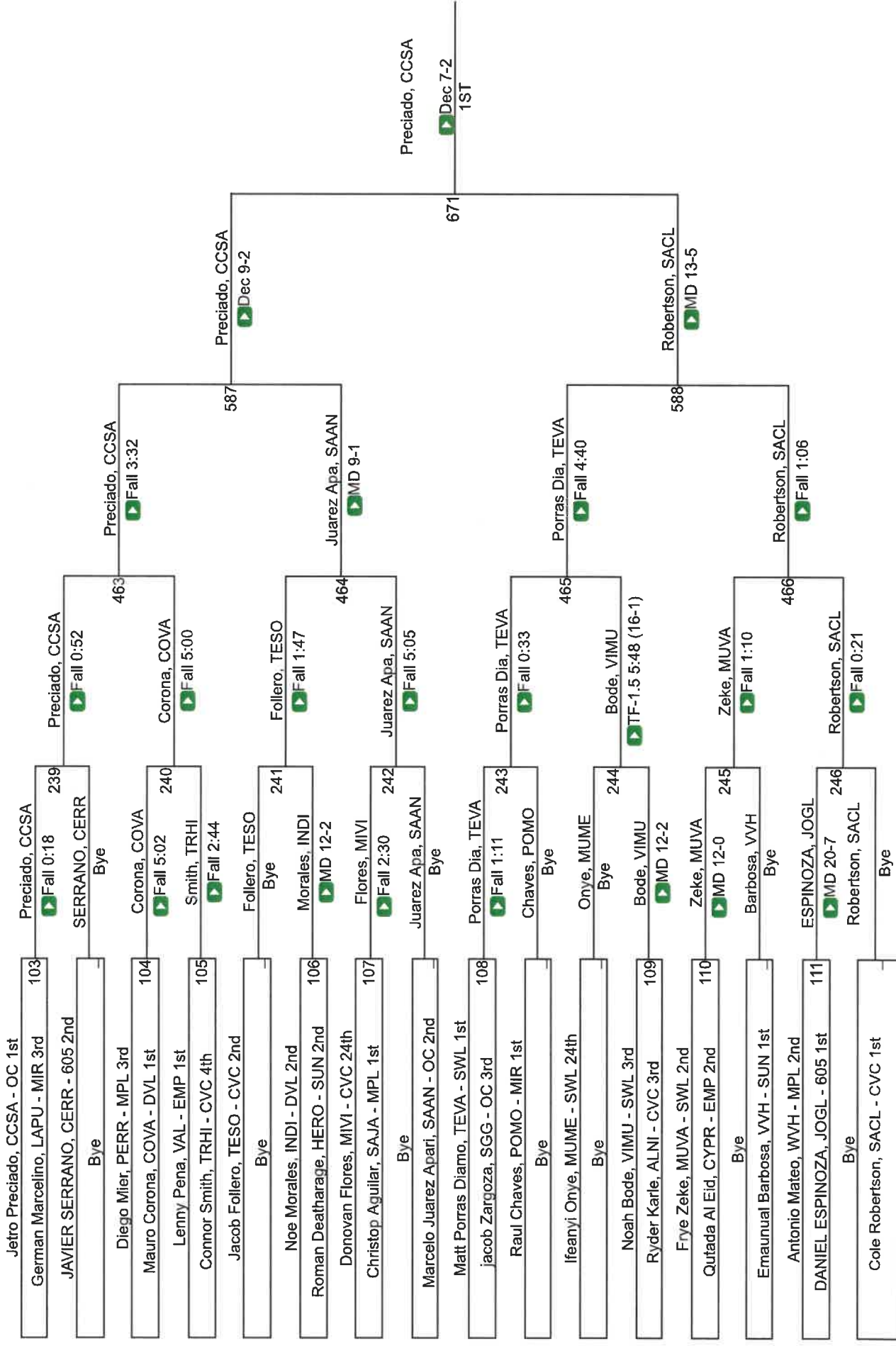







# 2022 CIF-SS Boys Individuals Eastern Division

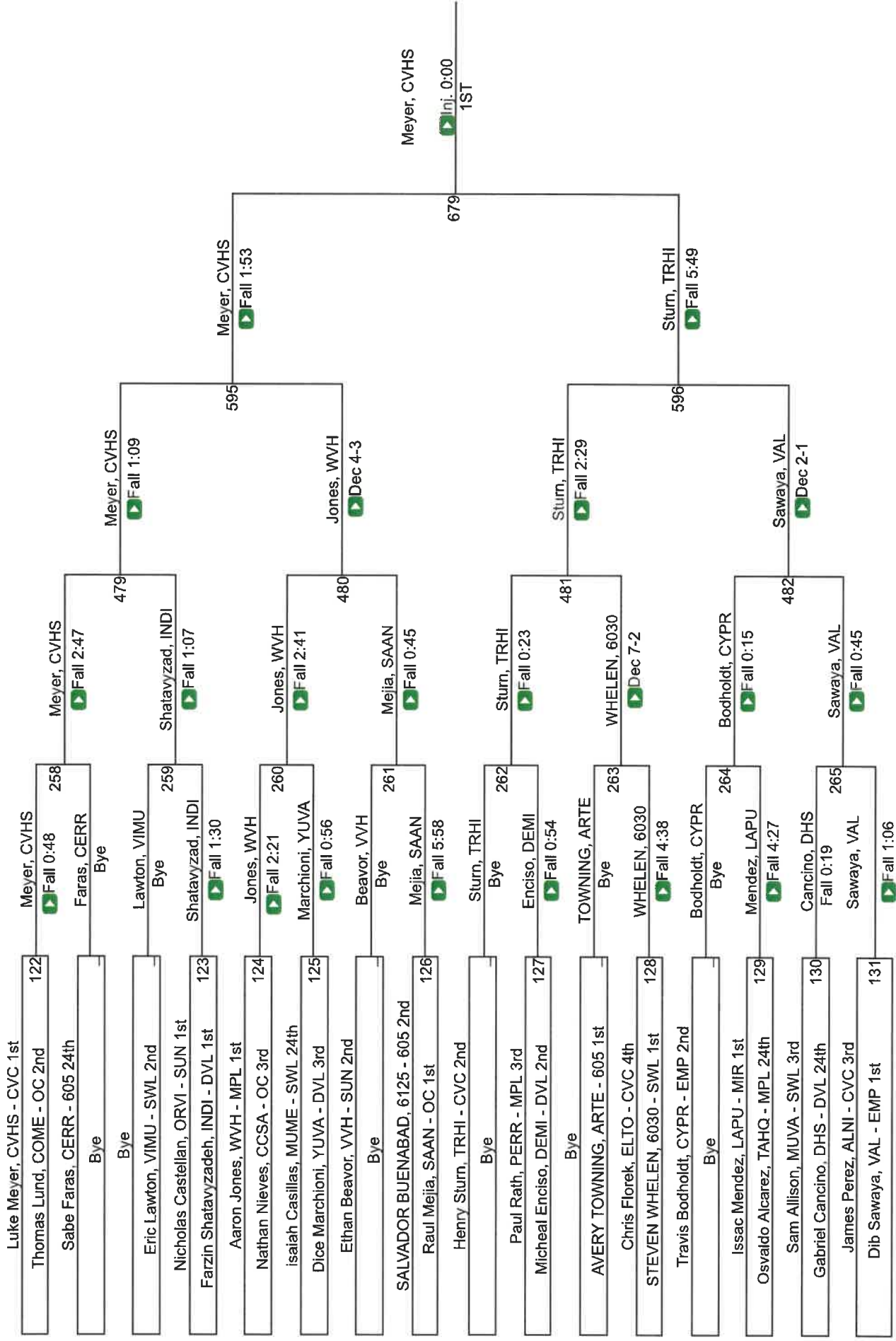





# 2022 CIF Inland Division WRESTLING CHAMPIONSHIPS Ayala High School - FEB. 11th & 12th



## MVP LOWER WEIGHT

Barreto, Fernando (12)  
132 LBS.  
Walnut  
5 FALLS

## MVP UPPER WEIGHT

Elliot, Seth (12)  
285 LBS.  
Millikan  
5 FALLS

### Placers

#### 106 LBS.

1st	Ramirez, Ronnie (9)	WAL	Walnut
2nd	Ruvalcaba, Isaac (12)	HIL	Hillcrest
3rd	Montoya, Christian (10)	SHL	South Hills
4th	MILLER, JOEY (11)	ELS	Elsinore
5th	Itchon, Nathan (9)	LBP	LB Poly
6th	CORCUERA, DARIUS (11)	PVY	Paloma Valley
7th	Ruvalcaba, Andrew (11)	MTB	Montebello
8th	Tang, Thien (12)	CLA	CLAREMONT

#### 113 LBS.

1st	Carranza, Arturo (12)	ARL	Arlington
2nd	Garcia, Christian (9)	WAL	Walnut
3rd	FLETES, DAVID (10)	CS	Canyon Springs
4th	Fernando, Cameron (12)	LC	La Canada
5th	Wallis, Charlie (11)	AL	alta loma
6th	RUIZ, BENJAMIN (10)	LAK	Lakeside
7th	Garcia, Dylan (9)	BON	Bonita
8th	Sandoval, Eduardo (10)	LBP	LB Poly

#### 120 LBS.

1st	MURILLO, RICHARD (10)	CS	Canyon Springs
2nd	Laverde, Gavin (11)	MIK	Millikan
3rd	Flores, Elijah (11)	WAL	Walnut
4th	RHODES, LARRY (10)	HEM	Hemet
5th	Lavery, Jeremy (12)	LBP	LB Poly
6th	Stearns, Jacob (12)	AL	alta loma
7th	Alcantar, Michael (11)	FIL	Fillmore
8th	Garcia, Andrew (10)	HIL	Hillcrest

#### 126 LBS.

1st	PERERYA, ANTHONY (12)	LAK	Lakeside
2nd	Laverde, Diego (12)	MIK	Millikan
3rd	Neeley, Ian (11)	WAL	Walnut
4th	Fernandez, Tristan (9)	BON	Bonita
5th	MIER, CHRISTIAN (11)	PVY	Paloma Valley
6th	Macamady, Bentley (10)	BD	Diamond Bar
7th	ORNELAS, CHRISTIAN (10)	CS	Canyon Springs
8th	CASTANON, ISAAC (12)	HEM	Hemet

#### 132 LBS.

1st	Barreto, Fernando (12)	WAL	Walnut
2nd	WELLS, JUSTIN (11)	LAK	Lakeside
3rd	ARREY, KRIS (11)	RP	Riverside Poly
4th	Winters, Samuel (12)	MIK	Millikan
5th	Lazcano, Ezekiel (12)	HUE	Hueneme
6th	DELGADO, SETH (12)	PVY	Paloma Valley
7th	Wong, Ryan (12)	BD	Diamond Bar
8th	JEONG, BEN (12)	TC	Temescal Canyon

#### 138 LBS.

1st	BENAVIDEZ, ELIJAH (11)	PVY	Paloma Valley
2nd	Castillo, Alister (11)	MIK	Millikan
3rd	RHODES, DAKOTA (12)	HEM	Hemet
4th	Perdomo, Jonathon (12)	ROM	Romona
5th	Christenson, Joseph (11)	LBP	LB Poly
6th	Kim, Jonah (11)	LC	La Canada
7th	Gomez Guerrero, Timothy (12)	HIL	Hillcrest
8th	Burnett, Charles (12)	MTB	Montebello

#### 145 LBS.

1st	Mikalo, Alex (12)	LC	La Canada
2nd	Lovato, Alexander (11)	MIK	Millikan
3rd	Yoshitake, Ryder (10)	SMO	San Marino
4th	Vasquez, Aaron (12)	SHL	South Hills
5th	Contreras, Joseph (10)	WAL	Walnut
6th	Hughes, Elijah (12)	JWN	J.W. North
7th	Parra, Cole (9)	BON	Bonita
8th	DOERING, CHRISTIAN (11)	HEM	Hemet

#### 152 LBS.

1st	Jauguui, Dominic (12)	AYA	Ayala
2nd	Lima, Kydyn (12)	MIK	Millikan
3rd	BROWN, BRANDON (12)	PVY	Paloma Valley
4th	Meza, Derrick (12)	WAL	Walnut
5th	Seio, Patrick (12)	SHL	South Hills
6th	Ocampo, Eli (12)	LKW	Lakewood
7th	Garcia, Chandler (12)	HIL	Hillcrest
8th	Lugo, Isaiah (11)	MTB	Montebello

#### 160 LBS.

1st	Pallares, Jake (12)	MIK	Millikan
2nd	Ishida, Junya (12)	LC	La Canada
3rd	Baker, Daniel (12)	SCH	Schurr
4th	Lewis, Chet (12)	SHL	South Hills
5th	Brown, Marquize (11)	GLD	Glendora
6th	Suhrob, Daniel (12)	PVY	Paloma Valley
7th	Lopez, Ramiro (12)	SGG	SAN GORGONIO
8th	Casey, Sean (11)	AL	alta loma

#### 168 LBS.

1st	ABACHERI, HARRISON (12)	JWN	J.W. North
2nd	MAJOR, JAVON (9)	PVY	Paloma Valley
3rd	Gomez, Ash (12)	MIK	Millikan
4th	GRANADO, JONATHAN (12)	TC	Temescal Canyon
5th	Foster, Broderick (11)	HIL	Hillcrest
6th	Ho, Brian (12)	CNY	Colony
7th	Fabio, Grant (12)	BON	Bonita
8th	Sous, Douchai (12)	LBW	LB Wilson

#### 182 LBS.

1st	BROWN, SAMUEL (12)	CS	Canyon Springs
2nd	GREGG, ETHAN (12)	HEM	Hemet
3rd	DIAZ, DANIEL (11)	PVY	Paloma Valley
4th	Rodriguez, Marco (11)	SCH	Schurr
5th	Race, Eric (12)	AL	alta loma
6th	Castaneda, Javier (11)	ROM	Romona
7th	Quirino, Freddie (11)	HIL	Hillcrest
8th	KAVEN, Ryan (10)	MIK	Millikan

#### 195 LBS.

1st	Gomez, Nathan (12)	MIK	Millikan
2nd	Martinez, Joseph (12)	ROM	Romona
3rd	Chavez, Gabriel (11)	HIL	Hillcrest
4th	Makdonado, Adrian (12)	CNY	Colony
5th	FERNANDEZ, ANDREW (12)	CS	Canyon Springs
6th	SOHRAB, BEN (11)	PVY	Paloma Valley
7th	ROMERO, BRYAN (11)	JWN	J.W. North
8th	Massef, Colin (9)	SMA	St. Monica Academy

#### 220 LBS.

1st	Arrington, Ryan (12)	SMO	San Marino
2nd	Jones, Cordae (12)	LBW	LB Wilson
3rd	Gomez, Jesus (12)	HIL	Hillcrest
4th	Borrego, Damian (12)	SP	Santa Paula
5th	FLORES, SIMON (10)	PVY	Paloma Valley
6th	OHI, MANI (11)	LAK	Lakeside
7th	Violette, Achilles (10)	PAT	Patriot
8th	Vargas, Victor (12)	CNY	Colony

#### 285 LBS.

1st	Elliot, Seth (12)	MIK	Millikan
2nd	Grimaldi, Andrew (12)	GLD	Glendora
3rd	TARASCIO, TJ (11)	JWN	J.W. North
4th	Fuentes, Angel (11)	ROM	Romona
5th	Jimenez, Michael (12)	FIL	Fillmore
6th	CASTRO, JOSE (12)	TC	Temescal Canyon
7th	Emeterio, Frank (9)	WAL	Walnut
8th	GOMEZ, ALFONSO (11)	HEM	Hemet

### Team Score

	Q
1 Millikan	10 292.0
2 Paloma Valley	6 229.5
3 Walnut	7 203.5
4 Hillcrest	4 153.0
5 La Canada	3 118.0
6 Canyon Springs	4 116.5
7 Hemet	3 110.0
8 Bonita	1 104.0
9 J.W. North	2 103.5
10 Lakeside	2 101.0
11 South Hills	4 101.0
12 Romona	3 87.5
13 alta loma	2 84.5
14 LB Poly	3 84.0
15 San Marino	2 68.0
16 Colony	1 66.0
17 Schurr	2 63.0
18 Temescal Canyon	1 62.5
19 Diamond Bar	0 62.5
20 Glendora	2 60.0
21 LB Wilson	1 58.0
22 CLAREMONT	0 56.5
23 Ayala	1 56.0
24 Arlington	1 50.0
25 Elsinore	1 43.0
26 Fillmore	1 47.0
27 Riverside Poly	1 42.0
28 Santa Paula	1 35.0
29 Patriot	0 33.0
30 Montebello	0 31.0
31 Lakewood	0 30.0
32 Hueneme	1 28.0
33 Grand Terrace	0 26.0
34 SAN GORGONIO	0 26.0
35 Rowland	0 21.0
36 Nordhoff	0 18.0
37 Mark Keppel	0 18.0
38 Alhambra	0 15.0
39 Hoover	0 15.0
40 RIALTO	0 15.0
41 Bell Gardens	0 14.0
42 San Gabriel	0 11.0
43 Aquinas	0 10.0
44 La Sierra	0 8.0
45 St. Monica Academy	0 8.0
46 Norte Vista	0 3.0
47 Monrovia	0 3.0
48 Fontana	0 3.0
49 Wilson	0 1.0
50 Cabrillo	0 0.0
51 Compton	0 0.0
52 Jordan	0 0.0
53 Rancho Verde	0 0.0
54 School 54	0 0.0
55 School 55	0 0.0
56 School 56	0 0.0
57 School 57	0 0.0
58 School 58	0 0.0
59 School 59	0 0.0
60 School 60	0 0.0
61 School 61	0 0.0
62 School 62	0 0.0

















2022 CIF Inland Division  
145 LBS.

Weight Class :

Mykalo, Alex (12)	LC	Mykalo, Alex (12)	LC	Mykalo, Alex (12)	LC		
Hernandez, Leo (10)	HUE	F	1,35	4.0			
Hamza, Ismael ( )	BD	Hamza, Ismael ( )	BD				
BURNS, WILL (10)	RP	F	:52	4.0			
Smith, Cale (10)	GLD	Smith, Cale (10)	GLD				
BYE							
Moore, Dylan (10)	MON	RIVERA, JACOB (11)	PVY				
RIVERA, JACOB (11)	PVY	F	2,25	4.0			
Vasquez, Aaron ( )	SHL	Vasquez, Aaron ( )	SHL				
Martinez, Ruben ( )	ARL	7	2	2.0			
Tolentino, Nathan (10)	ALH	Tolentino, Nathan (10)	ALH				
Leon, Bryan (11)	FON	12	8	2.0			
Rosales, Jacob (9)	AYA	HANCOCK, JOHN (10)	LAK				
HANCOCK, JOHN (10)	LAK	11	6	2.0			
BYE							
Yoshitake, Ryder (10)	SMO	Yoshitake, Ryder (10)	SMO				
Parra, Cole (9)	BON	Parra, Cole (9)	BON				
Hernandez, Leonardo (11)	RIA	9	2	2.0			
BYE							
Hughes, Elijah (12)	JWN	Hughes, Elijah (12)	JWN				
Bozoff, Michael ( )	LBW	DOERING, CHRISTIAN (11)	HEM				
DOERING, CHRISTIAN (11)	HEM	F	:49	4.0			
Godoy, Gerardo (11)	NV	Miguel, Joao (11)	SCH				
Miguel, Joao (11)	SCH	F	:59	4.0			
Contreras, Joseph ( )	WAL	Contreras, Joseph ( )	WAL				
BYE							
Ruiz, Adrian (10)	CNY	Ruiz, Adrian (10)	CNY				
Herrera, Enrique (11)	HIL	11	7	2.0			
Del Manzano, Diego (9)	NRD	Del Manzano, Diego (9)	NRD				
Ebisvya, Brandon ( )	WIL	F	3:34	4.0			
Campos, Sergio (9)	SGG	Lovato, Alexander (11)	MIK				
Lovato, Alexander (11)	MIK	F		4.0			
Hernandez, Leo (10)	HUE	Hernandez, Leo (10)	HUE				
BURNS, WILL (10)	RP	9	7	1.0			
BYE		HANCOCK, JOHN (10)	LAK				
Moore, Dylan (10)	MON	HANCOCK, JOHN (10)	LAK				
Martinez, Ruben ( )	ARL	5	1	1.0			
Leon, Bryan (11)	FON	MOORE, DYLAN (10)	MON				
Rosales, Jacob (9)	AYA	0.0					
Hernandez, Leonardo (12)	RIA	Tolentino, Nathan (10)	ALH				
BYE		F	3:14	3.0			
Bozoff, Michael ( )	LBW	Contreras, Joseph ( )	WAL				
Godoy, Gerardo (11)	NV	Contreras, Joseph ( )	WAL				
BYE							
Herrera, Enrique (11)	HIL	Smith, Cale (10)	GLD				
Ebisvya, Brandon ( )	WIL	F		3.0			
Campos, Sergio (9)	SGG	Smith, Cale (10)	GLD				
		F	5:55	3.0			
		Hamza, Ismael ( )	BD				
		TF	18-3	2.5			
		DOERING, CHRISTIAN (11)	HEM				
		DOERING, CHRISTIAN (11)	HEM				
		11	6	2.0			
		Yoshitake, Ryder (10)	SMO				
		Yoshitake, Ryder (10)	SMO				
		Bozoff, Michael ( )	LBW				
		Godoy, Gerardo (11)	NV				
		F	5:35	3.0			
		Ruiz, Adrian (10)	CNY				
		F	:38	3.0			
		Vasquez, Aaron ( )	SHL				
		14	5	3.0			
		Herrera, Enrique (11)	HIL				
		0.0					
		Miguel, Joao (11)	SCH				
		F	5:44	4.0			
		Parra, Cole (9)	BON				
		F	4:45	3.0			
		Parra, Cole (9)	BON				
		F	3:14	4.0			
		RIVERA, JACOB (11)	PVY				
		Hughes, Elijah (12)	JWN				
		DOERING, CHRISTIAN (11)	HEM				
		Parra, Cole (9)	BON				
		9	1	2.0			
		Hughes, Elijah (12)	JWN				
		5	4	2.0			
		Contreras, Joseph (10)	WAL				
		Contreras, Joseph (10)	WAL				
		12	3	4.0			
		Yoshitake, Ryder (10)	SMO				
		F	3:50	4.0			
		Vasquez, Aaron (12)	SHL				
		5	0	3.0			
		Vasquez, Aaron (12)	SHL				
		F	1:03	7.0			
		Hughes, Elijah (12)	JWN				
		7th					
		Contreras, Joseph (10)	WAL				
		5th					
		Contreras, Joseph (10)	WAL				

1st	Mykalo, Alex (12)	La Canada
2nd	Lovato, Alexander (11)	Millikan
3rd	Yoshitake, Ryder (10)	San Marino
4th	Vasquez, Aaron (12)	South Hills
5th	Contreras, Joseph (10)	Walnut
6th	Hughes, Elijah (12)	J.W. North
7th	Parra, Cole (9)	Bonita
8th	DOERING, CHRISTIAN (11)	Hemet

















**2022 CIF Inland Division  
285 LBS.**

Weight Class :

Elliot, Seth (12) MIK	Elliot, Seth (12) MIK	Elliot, Seth (12) MIK	
Munoz, Max (12) MTB	f 1:03 4.0	F 1:44 4.0	
FLORES, CHRIS (11) PVY	FLORES, CHRIS (11) PVY		
Lpez, Diego () SHL	F 2:50 4.0		
GOMEZ, ALFONSO (11) HEM	GOMEZ, ALFONSO (11) HEM	Elliot, Seth (12) MIK	
BYE	0.0	F ;25 7.0	
Cruz, Elvis (11) MON	Montalvo, Luis (12) SP	GOMEZ, ALFONSO (11) HEM	
Montalvo, Luis (12) SP	F 3:21 4.0	3 1 4.0	
CASTRO, JOSE (12) TC	CASTRO, JOSE (12) TC	Elliot, Seth (12) MIK	
Emeterio, Frank () WAL	F 1:06 4.0	F ;59 13.0	
BYE	0.0		
Gutierrez, Robert (12) AL	Gutierrez, Robert (12) AL	CASTRO, JOSE (12) TC	
EIshahawi, Anwar (11) SMO	Espinosa, Ryan (12) ALH	F 1:48 4.0	
Espinosa, Ryan (12) ALH	F 1:59 4.0	TARASCIO, TJ (11) JWN	
BYE	0.0	F ;22 7.0	
TARASCIO, TJ (11) JWN	TARASCIO, TJ (11) JWN	F 1:04 6.0	
Roman, Gerardo () ROW	Roman, Gerardo () ROW		
Pena, Nathan (9) FON	F 1:08 4.0	Elliot, Seth (12) MIK	
MARTINEZ, MATTHEW CS	Martinez, Joseph (11) BG	F ;26 6.0	
Martinez, Joseph (11) BG	7 2 2.0	1st	
Lozano, Luis (11) RIA	Bowman, Aaron (12) CNY	Martinez, Joseph (11) BG	
Bowman, Aaron (12) CNY	F 1:21 4.0	6 2 2.0	
Fuentes, Angel (11) ROM	Fuentes, Angel (11) ROM		
Orloff, Dorian (12) LBW	Fuentes, Angel (11) ROM	F 1:19 7.0	
Orloff, Dorian (12) LBW	F 1:29 4.0	F 2:42 4.0	
Grimaldi, Andrew (12) GLD	Grimaldi, Andrew (12) GLD		
BYE	0.0	Fuentes, Angel (11) ROM	
Ceron, Efrain (11) HIL	Ceron, Efrain (11) HIL	F 1:12 13.0	
Hartouniyas, Alex (11) HOO	5 3 2.0	F 1:02 6.0	
Gomez, Cristian () ARL	Gomez, Cristian () ARL		
Green, Bryan (9) LC	F 5:33 4.0	Grimaldi, Andrew (12) GLD	
Jimenez, Michael (12) FIL	Jimenez, Michael (12) FIL	F 2:55 7.0	
Torres, Santiago (12) SGG	F 3:55 4.0		
Munoz, Max (12) MTB	Munoz, Max (12) MTB		
Lpez, Diego () SHL	F 2:23 3.0	Grimaldi, Andrew (12) GLD	
BYE	0.0	F 1:02 6.0	
Cruz, Elvis (11) MON	0.0	5 3 2.0	
Emeterio, Frank () WAL	0.0	Gomez, Cristian () ARL	
BYE	0.0	F 5:33 4.0	
EIshahawi, Anwar (11) SMO	Montalvo, Luis (12) SP	Jimenez, Michael (12) FIL	
BYE	0.0	F 5:13 4.0	
Pena, Nathan (9) FON	FLORES, CHRIS (11) PVY		
MARTINEZ, MATTHEW (12) CS	FLORES, CHRIS (11) PVY	Jimenez, Michael (12) FIL	
Lozano, Luis (11) RIA	FLORES, CHRIS (11) PVY	F 5:13 4.0	
Orloff, Dorian (12) LBW	Orloff, Dorian (12) LBW		
BYE	0.0	Jimenez, Michael (12) FIL	
Hartouniyas, Alex (11) HOO	0.0	F 5:33 4.0	
Green, Bryan (9) LC	Bowman, Aaron (12) CNY		
Torres, Santiago (12) SGG	Torres, Santiago (12) SGG	Emeterio, Frank (9) WAL	
Roman, Gerardo () ROW	Roman, Gerardo () ROW	F ;33 3.0	
Roman, Gerardo () ROW	F ;31 3.0	F 2:30 5.0	
		Fuentes, Angel (11) ROM	
		F 2:47 7.0	
		Emeterio, Frank (9) WAL	
		F 3:41 3.0	
		Jimenez, Michael (12) FIL	
		F 1:38 4.0	
		CASTRO, JOSE (12) TC	
		F 1:38 4.0	

1st	Elliot, Seth (12)	Millikan
2nd	Grimaldi, Andrew (12)	Glendora
3rd	TARASCIO, TJ (11)	J.W. North
4th	Fuentes, Angel (11)	Romona
5th	Jimenez, Michael (12)	Fillmore
6th	CASTRO, JOSE (12)	Temescal Canyon
7th	Emeterio, Frank (9)	Walnut
8th	GOMEZ, ALFONSO (11)	Hemet



# 2022 CIF Northern Division WRESTLING CHAMPIONSHIPS

## Shadow Hills High School - FEB. 11th & 12th



### MVP LOWER WEIGHT

**BEAU MANTANONA**  
138 LBS. - PALM DESERT HS  
5 FALLS

### MVP UPPER WEIGHT

**CALEB VAN BUSKIRK**  
220 LBS. - PALM DESERT HS  
5 FALLS

### Placers

#### 106 LBS.

1st	Valdez, Paulo (9)	HES	HESPERIA
2nd	Ramirez, Jr., Eric (11)	PD	Palm Desert
3rd	Orosco, Jason (12)	APV	APPLE VALLEY
4th	Morales, Alex (11)	ST	South Torrance
5th	Andrade, Sebastian (11)	PAR	Paramount
6th	Tan, Kelvin (8)	RMI	Rancho Mirage
7th	KRUGER-NIELSEN, RYAN ( )	SUL	SULTANA
8th	CANNON, BRENT ( )	SER	SERRANO

#### 113 LBS.

1st	Guillermo, Ethan (11)	PD	Palm Desert
2nd	Hernandez, Hector (10)	HES	HESPERIA
3rd	Pedroza, Rylan (9)	BUE	Buena
4th	Delgado Gael (10)	WAR	Warren
5th	Halstead, Noah (10)	LAN	Lancaster
6th	Tapia, Cervando (11)	OX	Oxnard
7th	Felix-Lopez, Jose (9)	DOW	Downey
8th	Delgado, Gabriel (11)	ARR	Arroyo

#### 120 LBS.

1st	Valdez, Matthias (11)	HES	HESPERIA
2nd	WELLS, JORDEN ( )	SUL	SULTANA
3rd	Lopez, Andrew (12)	WAR	Warren
4th	Tan, Kyle (12)	RMI	Rancho Mirage
5th	Obregon, Edwin (11)	LAN	Lancaster
6th	Eibert, Chris (12)	VEN	Ventura
7th	Bornstein, Alex (12)	ST	South Torrance
8th	Valencia, Steven (11)	QH	Quartz Hill

#### 126 LBS.

1st	Mantanona, Brock (10)	PD	Palm Desert
2nd	Valdez, Ricardo (12)	HES	HESPERIA
3rd	Estrada, Robert (12)	HIG	Highland
4th	DIAZ, ANDREW ( )	SUL	SULTANA
5th	Jasso, Diego (12)	ST	South Torrance
6th	Baretto, Michael (12)	WT	West Torrance
7th	Henderson, Kion (12)	RMI	Rancho Mirage
8th	Wong, Wilson (12)	EMT	El Monte

#### 132 LBS.

1st	ROY EVAN ( )	BUR	BURROUGHS
2nd	Guillermo, Dylan (10)	PD	Palm Desert
3rd	Lons, Finn (11)	ARR	Arroyo
4th	Caballero, Christian (12)	SH	Shadow Hills
5th	Boniste, Jaden (10)	PAR	Paramount
6th	JABLONSKI, THOMAS ( )	SUL	SULTANA
7th	Arbues, Derek (12)	PCA	Pacifica
8th	Delgado, Caleb (9)	SRA	Santa Rosa Academy

#### 138 LBS.

1st	Mantanona, Beau (11)	PD	Palm Desert
2nd	Obregon, Heric (11)	LAN	Lancaster
3rd	Cruz, Larry (11)	ARR	Arroyo
4th	Newman, Charley (12)	BUE	Buena
5th	Nunez, Felicitio (10)	SH	Shadow Hills
6th	HERNANDEZ, ISAAC ( )	OH	OAK HILLS
7th	Munzula, Francisco (12)	LQ	La Quinta
8th	Cordoba, Caleb (12)	GAB	Gabriellino

#### 152 LBS.

1st	JEONG, JULIAN ( )	OH	OAK HILLS
2nd	Sepanlou, Evan (10)	QH	Quartz Hill
3rd	Quentin, Pierre (12)	ST	South Torrance
4th	VanBuskirk, Luke (10)	PD	Palm Desert
5th	Yu, Justin (12)	WT	West Torrance
6th	Chac, David (12)	EMT	El Monte
7th	Alonso, Jay (12)	RM	Rio Mesa
8th	Arellano, Lucas (11)	LQ	La Quinta

#### 160 LBS.

1st	Miller, John (11)	BUE	Buena
2nd	Guzman, Trylan (12)	LAW	Lawndale
3rd	BENTZ, DYLAN ( )	OH	OAK HILLS
4th	Morris, Noah (12)	PD	Palm Desert
5th	Castro, Roger (12)	EMT	El Monte
6th	Cortez, Isiah (12)	WAR	Warren
7th	MARTIN-ALFONSO, ALEX ( )	SER	SERRANO
8th	Mort, Jacob (12)	PAL	Palmdale

#### 170 LBS.

1st	Hanna, Tyler (12)	ST	South Torrance
2nd	McCown, Erik (11)	PD	Palm Desert
3rd	Guerra, Rafael (12)	DOW	Downey
4th	CHAFFEE, BLAKE ( )	SER	SERRANO
5th	Koslow, Warren (12)	MAR	Marshall
6th	GABRIEL, SHEA ( )	OH	OAK HILLS
7th	Castillo, Ivan (12)	LAW	Lawndale
8th	Araoz, Crispin (12)	RM	Rio Mesa

#### 182 LBS.

1st	CHAFFEE, TANNER ( )	SER	SERRANO
2nd	Gonzalez, Isaac (12)	WAR	Warren
3rd	Zeman, Zerek (12)	OX	Oxnard
4th	Castellanos, Isiah (12)	BUE	Buena
5th	Swan, Bronson (11)	PD	Palm Desert
6th	Stevenson, Frankie (10)	HES	HESPERIA
7th	Fernandez, Isaiiah (12)	DOW	Downey
8th	Flores, Elijah (12)	VEN	Ventura

#### 195 LBS.

1st	Kling, Sonny (10)	PD	Palm Desert
2nd	Medina, Jacob (12)	WAR	Warren
3rd	Fenlon, Konrad (10)	RM	Rio Mesa
4th	ROBLES, JOSEPH ( )	SUL	SULTANA
5th	Halstead, Nickolas (12)	LAN	Lancaster
6th	Sanchez, Eric (12)	ARR	Arroyo
7th	Duenas, Oscar (10)	MAR	Marshall
8th	HERNANDEZ, JACOB ( )	OH	OAK HILLS

#### 220 LBS.

1st	VanBuskirk, Caleb (12)	PD	Palm Desert
2nd	Solz, Anthony (12)	RM	Rio Mesa
3rd	REED, JAMES ( )	APV	APPLE VALLEY
4th	Mota, Max (12)	LQ	La Quinta
5th	Osuna, Santiaño (12)	LAW	Lawndale
6th	DELEON, ANTHONY ( )	SER	SERRANO
7th	KING, CHARLES ( )	OH	OAK HILLS
8th	Fajardo, Jeffrey (12)	WAR	Warren

#### Team Score

1	Palm Desert	13	361.0
2	Warren	5	175.0
3	HESPERIA	4	152.0
4	OAK HILLS	3	149.0
5	Downey	3	147.0
6	South Torrance	5	147.0
7	Buena	4	133.0
8	SERRANO	3	125.0
9	Arroyo	2	105.0
10	Lancaster	4	99.0
11	SULTANA	3	93.0
12	Rio Mesa	2	92.0
13	La Quinta	2	90.0
14	APPLE VALLEY	2	85.0
15	Shadow Hills	2	77.0
16	Ventura	0	70.0
17	Lawndale	2	64.0
18	Paramount	2	60.0
19	Quartz Hill	1	57.0
20	Oxnard	1	56.0
21	West Torrance	1	53.0
22	El Monte	1	53.0
23	Rancho Mirage	1	50.0
24	Highland	1	48.0
25	BURROUGHS	1	48.0
26	Channel Islands	1	42.0
27	Santa Rosa Academy	0	38.0
28	Marshall	1	32.0
29	Gabriellino	0	30.0
30	Littlerock	0	24.0
31	North Torrance	0	22.0
32	Palmdale	0	20.0
33	Palm Springs	0	18.0
34	Pacifica	0	18.0
35	Hamilton	0	17.0
36	Eastside	0	16.0
37	Knight	0	14.0
38	Mountain View	0	11.0
39	Nuvview Bridge	0	11.0
40	Dominguez	0	10.0
41	Antelope Valley	0	10.0
42	California School of the	0	4.0
43	South El Monte	0	3.0
44	Gahr	0	0.0
45	Rosemead	0	0.0
46	Torrance	0	0.0
47	Xavier Prep	0	0.0
48	School 48	0	0.0
49	School 49	0	0.0
50	School 50	0	0.0
51	School 51	0	0.0
52	School 52	0	0.0
53	School 53	0	0.0
54	School 54	0	0.0
55	School 55	0	0.0
56	School 56	0	0.0
57	School 57	0	0.0
58	School 58	0	0.0
59	School 59	0	0.0
60	School 60	0	0.0
61	School 61	0	0.0
62	School 62	0	0.0

2022 CIF Northern Division

Weight Class : 106 LBS.

Valdez, Paulo (9)	HES	Valdez, Paulo (9)	HES	Valdez, Paulo (9)	HES	
Delgado, Ismael (12)	WAR	F :47	4.0	F :54	4.0	
BYE						
Torres, Alex (10)	CI	Torres, Alex (10)	CI			
			0.0			
Santiago, Mason (9)	NT	Santiago, Mason (9)	NT	Valdez, Paulo (9)	HES	
Smith, Connor (9)	HAM	F 3:55	4.0	F 3:11	7.0	
BYE						
Barnette, Joseph (11)	DOW	Barnette, Joseph (11)	DOW			
			0.0			
Andrade, Sebastian (11)	PAR	Andrade, Sebastian (11)	PAR			
BYE			0.0			
BYE						
Hutton, Jonel (9)	OX	Hutton, Jonel (9)	OX			
			0.0			
Brown, Nate (10)	SRA	Brown, Nate (10)	SRA	Morales, Alex (11)	ST	
Long, Lucas (9)	ARR	F :47	4.0	F 12 10	5.0	
BYE						
Morales, Alex (11)	ST	Morales, Alex (11)	ST			
			0.0			
Ramirez, Jr., Eric (11)	PD	Ramirez, Jr., Eric (11)	PD			
Ayad, Roger (9)	WT	F 1:09	4.0			
BYE						
KRUGER-NIELSEN, RYAN	SUL	KRUGER-NIELSEN, RYAN	SUL			
			0.0			
Leija, Jonathan (9)	GAH	Leija, Jonathan (9)	GAH			
BYE			0.0			
Zelaya, Herberth (10)	EAS	Tan, Kelvin (9)	RMI			
Tan, Kelvin (9)	RMI	F 1:26	4.0			
CANNON, BRENT ( )	SER	CANNON, BRENT ( )	SER			
BYE			0.0			
BYE						
Hinojosa, Blaze (11)	LQ	Hinojosa, Blaze (11)	LQ			
			0.0			
Hernandez, Matt (9)	RM	Hernandez, Matt (9)	RM			
BYE			0.0			
Dylan, Carlos (9)	SH	Orosco, Jason (12)	APV			
Orosco, Jason (12)	APV	F 1:52	4.0			
Delgado, Ismael (12)	WAR	Delgado, Ismael (12)	WAR			
BYE			0.0			
Long, Lucas (9)	ARR	F 2:51	4.0			
Smith, Connor (9)	HAM	Smith, Connor (9)	HAM			
BYE			0.0			
BYE						
Hutton, Jonel (9)	OX	Hutton, Jonel (9)	OX			
			0.0			
BYE						
BYE						
Santiago, Mason (9)	NT	Santiago, Mason (9)	NT			
			0.0			
Brown, Nate (10)	SRA	Brown, Nate (10)	SRA			
BYE			0.0			
Torres, Alex (10)	CI	F 2:44	3.0			
Ayad, Roger (9)	WT	Ayad, Roger (9)	WT			
BYE			0.0			
BYE						
Hernandez, Matt (9)	RM	F 1:55	3.0			
Zelaya, Herberth (10)	EAS	Zelaya, Herberth (10)	EAS			
			0.0			
Hinojosa, Blaze (11)	LQ	F 1:17	3.0			
BYE						
BYE						
Leija, Jonathan (9)	GAH	Leija, Jonathan (9)	GAH			
BYE			0.0			
Dylan, Carlos (9)	SH	Dylan, Carlos (9)	SH			
			0.0			
KRUGER-NIELSEN, RYAN	SUL	KRUGER-NIELSEN, RYAN	SUL			
			5 1 1.0			
Barnette, Joseph (11)	DOW	Barnette, Joseph (11)	DOW			
CANNON, BRENT ( )	SER	CANNON, BRENT ( )	SER			
KRUGER-NIELSEN, RYAN ( )	SUL	KRUGER-NIELSEN, RYAN ( )	SUL			
7th		7th				
5th		5th				
3rd		3rd				
1st		1st				
8th		8th				
6th		6th				
4th		4th				
3rd		3rd				
2nd		2nd				
1st		1st				













2022 CIF Northern Division

Weight Class : 145 LBS.

Alonso, David (10)	PD	Alonso, David (10)	PD	Alonso, David (10)	PD	Alonso, David (10)	PD		
BYE			0.0	F	:38	6.0			
Summers, Kamari (11)	EAS	Killian, Jack (11)	WT						
Killian, Jack (11)	WT	F	1:34	4.0					
Root, McCarley (12)	MAR	Root, McCarley (12)	MAR						
BYE			0.0						
Coello, Matthew (11)	HIG	Toscano, Jose (12)	PS						
Toscano, Jose (12)	PS	F	:58	4.0					
TAMAYO DOMINIC ( )	OH	TAMAYO DOMINIC ( )	OH						
Aguilera, Nathaniel (10)	BUE	F	5:06	4.0					
BYE									
Macias, Robert (12)	QH	Macias, Robert (12)	QH						
Tan, Logan (12)	GAB	Tan, Logan (12)	GAB						
BYE			0.0						
Thompson, Erik (9)	LAW	Tan, Logan (12)	GAB						
Boos, Ethan (11)	LAN	Boos, Ethan (11)	LAN						
Boos, Ethan (11)	LAN	14	1	3.0					
Burke, Timothy (11)	CI	Burke, Timothy (11)	CI						
BYE			0.0						
Tousant, John (10)	DOM	Burke, Timothy (11)	CI						
Rivera, Edgar (11)	SH	F	:44	6.0					
FORTNEY, JACOB ( )	BUR	Tousant, John (10)	DOM						
Brandt, Nydle (10)	VEN	F	5:06	4.0					
BYE									
Ju, Kaydon (11)	ST	Brandt, Nydle (10)	VEN						
Ju, Kaydon (11)	ST	F	3:20	4.0					
Carpenter, Tyler (12)	DOW	Ju, Kaydon (11)	ST						
Marquez, Rafael (12)	HAM	F	0.0						
Rojas, Marlon (11)	SEL	Carpenter, Tyler (12)	DOW						
Carrasco, Jose (12)	KNI	F	2:53	4.0					
Garcia, Lelan (9)	ARR	Rojas, Marlon (11)	SEL						
Medina, Hector (11)	OX	F	1:01	4.0					
Gamaz, Jonathan (12)	HES	Carrasco, Jose (12)	KNI						
Irigoyen, Joe (12)	WAR	F	1:17	4.0					
BYE									
Summers, Kamari (11)	EAS	Garcia, Lelan (9)	ARR						
Boos, Ethan (11)	LAN	Medina, Hector (11)	OX						
Boos, Ethan (11)	LAN	F	1:59	4.0					
Coello, Matthew (11)	HIG	Gamaz, Jonathan (12)	HES						
Coello, Matthew (11)	HIG	0.0							
Aguilera, Nathaniel (10)	BUE	Irigoyen, Joe (12)	WAR						
BYE		F	2:29	4.0					
BYE									
Thompson, Erik (9)	LAW	Marquez, Rafael (12)	HAM						
BYE		F	3:45	3.0					
Rivera, Edgar (11)	SH	Rojas, Marlon (11)	SEL						
Rivera, Edgar (11)	SH	0.0							
FORTNEY, JACOB ( )	BUR	Brandt, Nydle (10)	VEN						
BYE		F	4:03	3.0					
Marquez, Rafael (12)	HAM	Garcia, Lelan (9)	ARR						
Marquez, Rafael (12)	HAM	Gamaz, Jonathan (12)	HES						
Rojas, Marlon (11)	SEL	F	2:48	3.0					
Brandt, Nydle (10)	VEN	Tousant, John (10)	DOM						
Garcia, Lelan (9)	ARR	F	4:47	3.0					
Gamaz, Jonathan (12)	HES								
Gamaz, Jonathan (12)	HES	Tousant, John (10)	DOM						
Tousant, John (10)	DOM	F	2:03	3.0					
Tousant, John (10)	DOM								
Tousant, John (10)	DOM	Carrasco, Jose (12)	KNI						
Tousant, John (10)	DOM	F	1:14	3.0					
Tousant, John (10)	DOM								
Tousant, John (10)	DOM	Tan, Logan (12)	GAB						
Tousant, John (10)	DOM	F	2:53	4.0					
Tousant, John (10)	DOM								
Tousant, John (10)	DOM	Tan, Logan (12)	GAB						
Tousant, John (10)	DOM	F	3:58	3.0					
Tousant, John (10)	DOM								
Tousant, John (10)	DOM	Marquez, Rafael (12)	HAM						
Tousant, John (10)	DOM	F	4:14	3.0					
Tousant, John (10)	DOM								
Tousant, John (10)	DOM	Marquez, Rafael (12)	HAM						
Tousant, John (10)	DOM	F	2:34	4.0					
Tousant, John (10)	DOM								
Tousant, John (10)	DOM	Toscano, Jose (12)	PS						
Tousant, John (10)	DOM	F	2:34	4.0					
Tousant, John (10)	DOM								
Tousant, John (10)	DOM	Toscano, Jose (12)	PS						
Tousant, John (10)	DOM	F	5:22	4.0					
Tousant, John (10)	DOM								
Tousant, John (10)	DOM	TAMAYO DOMINIC ( )	OH						
Tousant, John (10)	DOM	F	1:58	13.0					
Tousant, John (10)	DOM								
Tousant, John (10)	DOM	TAMAYO DOMINIC ( )	OH						
Tousant, John (10)	DOM	8	3	2.0					
Tousant, John (10)	DOM								
Tousant, John (10)	DOM	TAMAYO DOMINIC ( )	OH						
Tousant, John (10)	DOM	F	3:16	7.0					
Tousant, John (10)	DOM								
Tousant, John (10)	DOM	TAMAYO DOMINIC ( )	OH						
Tousant, John (10)	DOM	F	3:16	7.0					
Tousant, John (10)	DOM								
Tousant, John (10)	DOM	Tan, Logan (12)	GAB						
Tousant, John (10)	DOM	9	6	4.0					
Tousant, John (10)	DOM								
Tousant, John (10)	DOM	TAMAYO DOMINIC ( )	OH						
Tousant, John (10)	DOM	4	1	4.0					
Tousant, John (10)	DOM								
Tousant, John (10)	DOM	TAMAYO DOMINIC ( )	OH						
Tousant, John (10)	DOM	1st							
Tousant, John (10)	DOM								
Tousant, John (10)	DOM	Burke, Timothy (11)	CI						
Tousant, John (10)	DOM	F	2:03	7.0					
Tousant, John (10)	DOM								
Tousant, John (10)	DOM	Irigoyen, Joe (12)	WAR						
Tousant, John (10)	DOM	F	3:01	13.0					
Tousant, John (10)	DOM								
Tousant, John (10)	DOM	Irigoyen, Joe (12)	WAR						
Tousant, John (10)	DOM	11	1	6.0					
Tousant, John (10)	DOM								
Tousant, John (10)	DOM	Irigoyen, Joe (12)	WAR						
Tousant, John (10)	DOM	F	1:26	4.0					
Tousant, John (10)	DOM								
Tousant, John (10)	DOM	Irigoyen, Joe (12)	WAR						
Tousant, John (10)	DOM	F	1:26	4.0					
Tousant, John (10)	DOM								
Tousant, John (10)	DOM	Irigoyen, Joe (12)	WAR						
Tousant, John (10)	DOM	F	1:26	4.0					
Tousant, John (10)	DOM								
Tousant, John (10)	DOM	Irigoyen, Joe (12)	WAR						
Tousant, John (10)	DOM	F	1:26	4.0					
Tousant, John (10)	DOM								
Tousant, John (10)	DOM	Irigoyen, Joe (12)	WAR						
Tousant, John (10)	DOM	F	1:26	4.0					
Tousant, John (10)	DOM								
Tousant, John (10)	DOM	Irigoyen, Joe (12)	WAR						
Tousant, John (10)	DOM	F	1:26	4.0					
Tousant, John (10)	DOM								
Tousant, John (10)	DOM	Irigoyen, Joe (12)	WAR						
Tousant, John (10)	DOM	F	1:26	4.0					
Tousant, John (10)	DOM								
Tousant, John (10)	DOM	Irigoyen, Joe (12)	WAR						
Tousant, John (10)	DOM	F	1:26	4.0					
Tousant, John (10)	DOM								
Tousant, John (10)	DOM	Irigoyen, Joe (12)	WAR						
Tousant, John (10)	DOM	F	1:26	4.0					
Tousant, John (10)	DOM								
Tousant, John (10)	DOM	Irigoyen, Joe (12)	WAR						
Tousant, John (10)	DOM	F	1:26	4.0					
Tousant, John (10)	DOM								
Tousant, John (10)	DOM	Irigoyen, Joe (12)	WAR						
Tousant, John (10)	DOM	F	1:26	4.0					
Tousant, John (10)	DOM								
Tousant, John (10)	DOM	Irigoyen, Joe (12)	WAR						
Tousant, John (10)	DOM	F	1:26	4.0					
Tousant, John (10)	DOM								
Tousant, John (10)	DOM	Irigoyen, Joe (12)	WAR						
Tousant, John (10)	DOM	F	1:26	4.0					
Tousant, John (10)	DOM								
Tousant, John (10)	DOM	Irigoyen, Joe (12)	WAR						
Tousant, John (10)	DOM	F	1:26	4.0					
Tousant, John (10)	DOM								
Tousant, John (10)	DOM	Irigoyen, Joe (12)	WAR						
Tousant, John (10)	DOM	F	1:26	4.0					
Tousant, John (10)	DOM								
Tousant, John (10)	DOM	Irigoyen, Joe (12)	WAR						
Tousant, John (10)	DOM	F	1:26	4.0					
Tousant, John (10)	DOM								
Tousant, John (10)	DOM	Irigoyen, Joe (12)	WAR						
Tousant, John (10)	DOM	F	1:26	4.0					
Tousant, John (10)	DOM								
Tousant, John (10)	DOM	Irigoyen, Joe (12)	WAR						
Tousant, John (10)	DOM	F	1:26	4.0					
Tousant, John (10)	DOM								
Tousant, John (10)	DOM	Irigoyen, Joe (12)	WAR						
Tousant, John (10)	DOM	F	1:26	4.0					
Tousant, John (10)	DOM								







2022 CIF Northern Division

Weight Class : 182 LBS.

CHAFFEE TANNER ( ) SER		CHAFFEE TANNER ( ) SER		CHAFFEE TANNER ( ) SER		CHAFFEE TANNER ( ) SER		CHAFFEE TANNER ( ) SER		CHAFFEE TANNER ( ) SER		CHAFFEE TANNER ( ) SER																	
Guerrero, Ricky (11)	MVV	F	:56	4.0	CHAFFEE TANNER ( )	F	5:37	4.0	CHAFFEE TANNER ( )	F	3:03	7.0	CHAFFEE TANNER ( )	F	3:54	13.0													
Faust, Jordan (11)	ANV	Fernandez, Isaiah (12)	DOW	4.0	Flores, Brandon (12)	EMT	0.0	Flores, Elijah (12)	VEN	F	3:30	4.0	CHAFFEE TANNER ( )	F	3:54	13.0													
Fernandez, Isaiah (12)	DOW	F	:59	4.0	BYE		0.0	Ramirez, Nehemiah (11)	SH	19	4	3.0	CHAFFEE TANNER ( )	F	3:54	13.0													
Flores, Brandon (12)	EMT	Flores, Brandon (12)	EMT	0.0	Swan, Bronson (11)	PD	0.0	Swan, Bronson (11)	PD	11	1	5.0	CHAFFEE TANNER ( )	F	3:54	13.0													
BYE				0.0	BYE		0.0	LEON, ZACKARY ( )	APV				CHAFFEE TANNER ( )	F	3:54	13.0													
Flores, Elijah (12)	VEN	Flores, Elijah (12)	VEN	3.0	LEON, ZACKARY ( )	APV		Rogers, Ethan (10)	WT	F	:41	4.0	Castellanos, Isiah (12)	BUE	F	1:10	7.0												
Ramirez, Nehemiah (11)	SH	19	4	3.0	Rogers, Ethan (10)	WT	F	:41	4.0	Castellanos, Isiah (12)	BUE	F	:26	4.0	Castellanos, Isiah (12)	BUE	F	4:24	4.0										
Swan, Bronson (11)	PD	Swan, Bronson (11)	PD	0.0	Castellanos, Isiah (12)	BUE	F	:26	4.0	Baltazar, Alfredo (9)	CSDR	F	:26	4.0	Castellanos, Isiah (12)	BUE	F	4:24	4.0										
BYE				0.0	Baltazar, Alfredo (9)	CSDR	F	:26	4.0	Berkeley, Charles (11)	HIG	Stevenson, Frankie (10)	HES	F	1:08	4.0	Castellanos, Isiah (12)	BUE	F	4:24	4.0								
LEON, ZACKARY ( )	APV	LEON, ZACKARY ( )	APV	4.0	Berkeley, Charles (11)	HIG	Stevenson, Frankie (10)	HES	F	1:08	4.0	Ramirez, Benjamin (12)	ARR	Ramirez, Benjamin (12)	ARR	F	:40	4.0	Castellanos, Isiah (12)	BUE	F	4:24	4.0						
Rogers, Ethan (10)	WT	F	:41	4.0	Stevenson, Frankie (10)	HES	F	1:08	4.0	Ramirez, Benjamin (12)	ARR	F	:40	4.0	Ramirez, Benjamin (12)	ARR	F	1:52	4.0	Castellanos, Isiah (12)	BUE	F	4:24	4.0					
Castellanos, Isiah (12)	BUE	Castellanos, Isiah (12)	BUE	4.0	Ramirez, Benjamin (12)	ARR	F	1:52	4.0	BYE				4.0	Zeman, Zerek (12)	OX	F	1:15	7.0	CHAFFEE TANNER ( )	F	5	3	4.0					
Baltazar, Alfredo (9)	CSDR	F	:26	4.0	BYE			4.0	Gil, German (10)	PAR			0.0	Zeman, Zerek (12)	OX	F	1:15	7.0	CHAFFEE TANNER ( )	F	5	3	4.0						
Berkeley, Charles (11)	HIG	Stevenson, Frankie (10)	HES	4.0	Gil, German (10)	PAR		0.0	Galvan, Ryan (10)	SRA	Rivera, Carlos (12)	LAW	14	8	2.0	Zeman, Zerek (12)	OX	F	5:26	6.0	CHAFFEE TANNER ( )	F	5	3	4.0				
Stevenson, Frankie (10)	HES	F	1:08	4.0	Galvan, Ryan (10)	SRA	Rivera, Carlos (12)	LAW	14	8	2.0	Zeman, Zerek (12)	OX	F	5:26	6.0	Zeman, Zerek (12)	OX	F	5:26	6.0	CHAFFEE TANNER ( )	F	5	3	4.0			
Ramirez, Benjamin (12)	ARR	Ramirez, Benjamin (12)	ARR	4.0	Rivera, Carlos (12)	LAW	14	8	2.0	BYE				6.0	Zeman, Zerek (12)	OX	F	5:26	6.0	CHAFFEE TANNER ( )	F	5	3	4.0					
Guzman, Anthony (10)	KNI	F	:40	4.0	BYE			0.0	Zeman, Zerek (12)	OX	Zeman, Zerek (12)	OX			0.0	Zeman, Zerek (12)	OX	F	5:26	6.0	CHAFFEE TANNER ( )	F	5	3	4.0				
BYE				4.0	Zeman, Zerek (12)	OX		0.0	Esposito, Matt (10)	ST	Gonzalez, Jorge (12)	CI	F	1:08	4.0	Gonzalez, Isaac (12)	WAR	F	4:49	13.0	CHAFFEE TANNER ( )	F	5	3	4.0				
Gil, German (10)	PAR	Gil, German (10)	PAR	0.0	Esposito, Matt (10)	ST	Gonzalez, Jorge (12)	CI	F	1:08	4.0	Gonzalez, Jorge (12)	CI	F	1:08	4.0	Gonzalez, Isaac (12)	WAR	F	4:49	13.0	CHAFFEE TANNER ( )	F	5	3	4.0			
Galvan, Ryan (10)	SRA	Rivera, Carlos (12)	LAW	2.0	Gonzalez, Jorge (12)	CI	Def	4.0	BYE				4.0	Gonzalez, Isaac (12)	WAR	F	5:56	6.0	Gonzalez, Isaac (12)	WAR	F	:50	7.0	CHAFFEE TANNER ( )	F	5	3	4.0	
Rivera, Carlos (12)	LAW	14	8	2.0	Trosper, William (12)	RMI		0.0	Trosper, William (12)	RMI			0.0	Gonzalez, Isaac (12)	WAR	F	5:56	6.0	Gonzalez, Isaac (12)	WAR	F	:50	7.0	CHAFFEE TANNER ( )	F	5	3	4.0	
BYE				2.0	Cano, Marvin (12)	MAR	Mejia, William (12)	LIT	0.0	BYE			0.0	Gonzalez, Isaac (12)	WAR	F	5:56	6.0	Gonzalez, Isaac (12)	WAR	F	:50	7.0	CHAFFEE TANNER ( )	F	5	3	4.0	
Zeman, Zerek (12)	OX	Zeman, Zerek (12)	OX	0.0	Mejia, William (12)	LIT	F	:48	4.0	Trosper, William (12)	RMI			0.0	Gonzalez, Isaac (12)	WAR	F	5:56	6.0	Gonzalez, Isaac (12)	WAR	F	:50	7.0	CHAFFEE TANNER ( )	F	5	3	4.0
Esposito, Matt (10)	ST	Gonzalez, Jorge (12)	CI	4.0	BYE			4.0	Gonzalez, Isaac (12)	WAR	F	5:56	6.0	Gonzalez, Isaac (12)	WAR	F	5:56	6.0	Gonzalez, Isaac (12)	WAR	F	:50	7.0	CHAFFEE TANNER ( )	F	5	3	4.0	
Gonzalez, Jorge (12)	CI	F	1:08	4.0	Trosper, William (12)	RMI		0.0	Gonzalez, Isaac (12)	WAR	F	5:56	6.0	Gonzalez, Isaac (12)	WAR	F	5:56	6.0	Gonzalez, Isaac (12)	WAR	F	:50	7.0	CHAFFEE TANNER ( )	F	5	3	4.0	
BYE				4.0	Cano, Marvin (12)	MAR	Mejia, William (12)	LIT	0.0	Gonzalez, Isaac (12)	WAR	F	5:56	6.0	Gonzalez, Isaac (12)	WAR	F	5:56	6.0	Gonzalez, Isaac (12)	WAR	F	:50	7.0	CHAFFEE TANNER ( )	F	5	3	4.0
Trosper, William (12)	RMI	Trosper, William (12)	RMI	0.0	Mejia, William (12)	LIT	F	:48	4.0	Gonzalez, Isaac (12)	WAR	F	5:56	6.0	Gonzalez, Isaac (12)	WAR	F	5:56	6.0	Gonzalez, Isaac (12)	WAR	F	:50	7.0	CHAFFEE TANNER ( )	F	5	3	4.0
Cano, Marvin (12)	MAR	Mejia, William (12)	LIT	4.0	BYE			4.0	Gonzalez, Isaac (12)	WAR	F	5:56	6.0	Gonzalez, Isaac (12)	WAR	F	5:56	6.0	Gonzalez, Isaac (12)	WAR	F	:50	7.0	CHAFFEE TANNER ( )	F	5	3	4.0	
Mejia, William (12)	LIT	F	:48	4.0	Gonzalez, Isaac (12)	WAR	F	5:56	6.0	Gonzalez, Isaac (12)	WAR	F	5:56	6.0	Gonzalez, Isaac (12)	WAR	F	5:56	6.0	Gonzalez, Isaac (12)	WAR	F	:50	7.0	CHAFFEE TANNER ( )	F	5	3	4.0
BYE				4.0	Gonzalez, Isaac (12)	WAR	F	5:56	6.0	Gonzalez, Isaac (12)	WAR	F	5:56	6.0	Gonzalez, Isaac (12)	WAR	F	5:56	6.0	Gonzalez, Isaac (12)	WAR	F	:50	7.0	CHAFFEE TANNER ( )	F	5	3	4.0
Gonzalez, Isaac (12)	WAR	Gonzalez, Isaac (12)	WAR	0.0	Gonzalez, Isaac (12)	WAR	F	5:56	6.0	Gonzalez, Isaac (12)	WAR	F	5:56	6.0	Gonzalez, Isaac (12)	WAR	F	5:56	6.0	Gonzalez, Isaac (12)	WAR	F	:50	7.0	CHAFFEE TANNER ( )	F	5	3	4.0

- 1st CHAFFEE TANNER ( ) SERRANO
- 2nd Gonzalez, Isaac (12) Warren
- 3rd Zeman, Zerek (12) Oxnard
- 4th Castellanos, Isiah (12) Buena
- 5th Swan, Bronson (11) Palm Desert
- 6th Stevenson, Frankie (10) HESPERIA
- 7th Fernandez, Isaiah (12) Downey
- 8th Flores, Elijah (12) Ventura







2022 CIF Northern Division

Weight Class : 285 LBS.

Herrera, Daniel (10) PD	Herrera, Daniel (10) PD	Herrera, Daniel (10) PD	Herrera, Daniel (10) PD	
BYE	0,0	F 1:57 6.0		
Smith, Keyshawn (10) PAR	Smith, Keyshawn (10) PAR			
WALSH, PRESTON ( ) OH	F :36 4.0			
Perez, Pedro (12) SEL	Alford, Jayden (11) NT			
Alford, Jayden (11) NT	F 5:12 4.0			
BYE				
Moreno, Jose (11) SH	Moreno, Jose (11) SH			
	0,0	F 2:39 6.0		
FRANCO, ANGELO ( ) SER	FRANCO, ANGELO ( ) SER			
BYE	0,0			
Klauminzer, Kasey (10) SRA	Del Villar, Agustin (12) LAN			
Del Villar, Agustin (12) LAN	F :43 4.0			
Delgado, Juan (11) RMI	Delgado, Juan (11) RMI			
BYE	0,0			
Caram, Matt (11) QH	Garcia, Anthony (12) RM			
Garcia, Anthony (12) RM	F 2:31 4.0			
Patterson, Jackson (12) ST	Patterson, Jackson (12) ST			
Velez, Andrew (9) MAR	F :31 4.0			
Opolka, Adrian (11) VEN	Opolka, Adrian (11) VEN			
Venezas, Sonny (11) HIG	F 3:24 4.0			
Rodriguez, Pedro (12) CI	Rodriguez, Pedro (12) CI			
BYE	0,0			
ARIAS, XAVIER ( ) APV	Zendejas, Jose (11) LQ			
Zendejas, Jose (11) LQ	F 3:15 4.0			
Huerta, Matthew (11) WAR	Huerta, Matthew (11) WAR			
BYE	0,0			
Arambola, David (9) BUE	Flores, Raymond (10) MVW			
Flores, Raymond (10) MVW	F :40 4.0			
Blakely, Jordan (12) EAS	Blakely, Jordan (12) EAS			
Mercado, Daniel (12) ARR	F :30 4.0			
Soto, Dezmen (12) CSDR	Moreno, Adan (12) DOW			
Moreno, Adan (12) DOW	F 1:20 4.0			
BYE				
WALSH, PRESTON ( ) OH	WALSH, PRESTON ( ) OH			
0,0	0,0			
Perez, Pedro (12) SEL	Delgado, Juan (11) RMI			
0,0	F :50 4.0			
BYE				
Del Villar, Agustin (12) LAN	Del Villar, Agustin (12) LAN			
0,0	F :16 3.0			
BYE				
Klauminzer, Kasey (10) SRA	Klauminzer, Kasey (10) SRA			
0,0	0,0			
Alford, Jayden (11) NT	F :55 4.0			
BYE				
Caram, Matt (11) QH	Caram, Matt (11) QH			
0,0	0,0			
Smith, Keyshawn (10) PAR	5 2 2.0			
Velez, Andrew (9) MAR	Venezas, Sonny (11) HIG			
0,0	F 1:19 3.0			
BYE	Blakely, Jordan (12) EAS			
0,0	F :37 3.0			
ARIAS, XAVIER ( ) APV	ARIAS, XAVIER ( ) APV			
0,0	0,0			
Flores, Raymond (10) MVW	F 1:33 4.0			
BYE				
Arambola, David (9) BUE	Rodriguez, Pedro (12) CI			
0,0	7 0 1.0			
Mercado, Daniel (12) ARR	Rodriguez, Pedro (12) CI			
0,0	9 4 1.0			
Soto, Dezmen (12) CSDR	Mercado, Daniel (12) ARR			
0,0	F 4:55 3.0			
Opolka, Adrian (11) VEN	Opolka, Adrian (11) VEN			
1 0 1.0	1 0 1.0			
BYE				
Del Villar, Agustin (12) LAN	Del Villar, Agustin (12) LAN			
F :31 3.0	F :31 3.0			
Huerta, Matthew (11) WAR	Huerta, Matthew (11) WAR			
F 2:47 4.0	F 2:47 4.0			
Zendejas, Jose (11) LQ	Zendejas, Jose (11) LQ			
F 1:18 5.0	F 1:18 5.0			
FRANCO, ANGELO ( ) SER	FRANCO, ANGELO ( ) SER			
F 2:58 7.0	F 2:58 7.0			
FRANCO, ANGELO ( ) SER	FRANCO, ANGELO ( ) SER			
F 2:58 4.0	F 2:58 4.0			
3rd	3rd			
Rodriguez, Pedro (12) CI	Rodriguez, Pedro (12) CI			
6 4 3.0	6 4 3.0			
Patterson, Jackson (12) ST	Patterson, Jackson (12) ST			
F 1:58 7.0	F 1:58 7.0			
Moreno, Jose (11) SH	Moreno, Jose (11) SH			
Huerta, Matthew (11) WAR	Huerta, Matthew (11) WAR			
ARIAS, XAVIER ( ) APV	ARIAS, XAVIER ( ) APV			
F 4:00 3.0	F 4:00 3.0			
Rodriguez, Pedro (12) CI	Rodriguez, Pedro (12) CI			
F :50 4.0	F :50 4.0			

- 1st Herrera, Daniel (10) Palm Desert
- 2nd Moreno, Adan (12) Downey
- 3rd FRANCO, ANGELO ( ) SERRANO
- 4th Patterson, Jackson (12) South Torrance
- 5th Zendejas, Jose (11) La Quinta
- 6th Rodriguez, Pedro (12) Channel Islands
- 7th ARIAS, XAVIER ( ) APPLE VALLEY
- 8th Huerta, Matthew (11) Warren

# 2022 CIF SOUTHERN DIVISION WRESTLING CHAMPIONSHIPS

## Carter High School - February 11th & 12th



### CO-MVP LOWER WEIGHT

MARCUS MEDINA 138 LBS- SERVITE HS 4 FALLS 1 TECH FALL	JOSEPH DURAN 145 LBS- COLTON HS 4 FALLS
--	---

### MVP UPPER WEIGHT

NICCO RUIZ  
152 LBS- ST. JOHN BOSCO  
5 FALLS

#### Placers

##### 106 LBS.

1st Poe, Elijah (10)	SRV	Servite
2nd Casas, Elias (9)	CAJ	Cajon
3rd Carrillo, Mason (10)	ROY	Royal
4th Cruz, Isaiah (10)	MAY	Mayfair
5th Dominguez, Jacob (11)	SM	arcos (Santa Barbara)
6th Mason, Anthony (10)	LM	La Mirada
7th Lazaro, Paulino (10)	WES	Western
8th Dye, Austin (9)	SBR	Santa Barbara

##### 113 LBS.

1st Lucio, Anthony (10)	SRV	Servite
2nd McLaughlin, Jake (12)	MD	Mater Dei
3rd Solis, Luis (11)	CAR	Carter
4th Reyes, JoseAngel (12)	MAY	Mayfair
5th Medel, Eddie (12)	WES	Western
6th Lopez, Jordan (11)	REV	Redlands East Valley
7th Gutierrez, Ian (10)	YUC	Yucaipa
8th Pearce, Cody (11)	DP	Dos Pueblos

##### 120 LBS.

1st Johnson, Thomas (9)	SY	Santa Ynez
2nd Grimmerger, Ethan (12)	SRV	Servite
3rd Ponce, Ricardo (10)	REV	Redlands East Valley
4th Gonzalez, Isaac (9)	WES	Western
5th Andrews, Lojan (11)	MOO	Moorpark
6th Maeda, Brennan (12)	SMG	Santa Margarita
7th Alfaro, Arturo (11)	CAM	Camarillo
8th Ramirez, Jose (11)	CLT	Colton

##### 126 LBS.

1st Cholakyian, Grigor (10)	SJB	St. John Bosco
2nd Serizawa, Dustin (12)	OL	Orange Lutheran
3rd Gonzales, Emilio (11)	CAM	Camarillo
4th Mojonier, Troy (12)	SY	Santa Ynez
5th Daugherty, Kieran (11)	YUC	Yucaipa
6th Newman, Alex (10)	SRV	Servite
7th Perez, David (11)	CAR	Carter
8th Garcia, Carlos (11)	MAG	Magnolia

##### 132 LBS.

1st Antonio, Joseph (9)	SJB	St. John Bosco
2nd Paschia, Lucas (12)	VALV	Valencia/Valencia
3rd Zuniga, Anthony (11)	CAR	Carter
4th Robledo, Elijah (10)	MAY	Mayfair
5th O'Neil, Cooper (12)	ROY	Royal
6th Simons, Daniel (11)	CAM	Camarillo
7th McIntosh, Benjamin (10)	RDL	Redlands
8th Thompson, Peter (10)	OL	Orange Lutheran

##### 138 LBS.

1st Medina, Marcus (12)	SRV	Servite
2nd Avila, Bryant (12)	CAR	Carter
3rd Tellez, Yazir (10)	SJB	St. John Bosco
4th Lopez, Andrew (12)	CAJ	Cajon
5th DeWitt, Xander (11)	YUC	Yucaipa
6th Hansen, Aidan (12)	ROY	Royal
7th Irwin, Edward (12)	OL	Orange Lutheran
8th Maldonado, Isaiah (10)	MAY	Mayfair

##### 145 LBS.

1st Duran, Joseph (12)	CLT	Colton
2nd Segura, Noah (12)	SRV	Servite
3rd Mendoza, Sammy (12)	YUC	Yucaipa
4th Lobo, Dominic (12)	OL	Orange Lutheran
5th Otero, Sean (10)	NWK	Norwalk
6th Tolento, Robert (12)	CAR	Carter
7th Allen, Dominic (12)	MAY	Mayfair
8th Belton, Jeremiah (12)	SJB	St. John Bosco

##### 152 LBS.

1st Ruiz, Nicco (11)	SJB	St. John Bosco
2nd Freeland, Aidan (12)	FMT	Fairmont SJC
3rd Hernandez, Mason (10)	CV	Citrus Valley
4th Voce, Jeremiah (12)	RIM	Rim of the World
5th Dunwoody, Lance (11)	OL	Orange Lutheran
6th Khaloufi, Kadin (12)	REV	Redlands East Valley
7th Echerisim, Bryan (12)	NWK	Norwalk
8th Valdez, Josh (11)	SRV	Servite

##### 160 LBS.

1st Aranda, Oscar (12)	SJB	St. John Bosco
2nd Barajas, Julian (11)	MAY	Mayfair
3rd Estrada, Joseph (12)	YUC	Yucaipa
4th Fryer, Jonah (12)	NWK	Norwalk
5th Torres, Juan (12)	SM	arcos (Santa Barbara)
6th Madriajal, Nicholas (11)	ROY	Royal
7th Dervartanian, Joseph (11)	OL	Orange Lutheran
8th Parra, Angel (11)	SBR	Santa Barbara

##### 170 LBS.

1st Munoz, Alex (11)	VALV	Valencia/Valencia
2nd Martindale, Nathaniel (12)	YUC	Yucaipa
3rd Galicia, Abraham (12)	SJB	St. John Bosco
4th Maldonado, Francisco (12)	MAY	Mayfair
5th Gurovich, Daniel (11)	CAM	Camarillo
6th Camacho, Kevin (11)	REV	Redlands East Valley
7th Campbell, Connor (12)	RDL	Redlands
8th Orozco, Juan (12)	WES	Western

##### 182 LBS.

1st Ayala, Mark (11)	SJB	St. John Bosco
2nd Costa, Diego (10)	YUC	Yucaipa
3rd Fulgentes, William (12)	ROY	Royal
4th McWilliams, Max (10)	FMT	Fairmont SJC
5th Martinez, Angel (12)	CAB	Cabrillo/Lompoc
6th Bahra, Matthew (9)	LM	La Mirada
7th Sims, Kyle (12)	MOO	Moorpark
8th Flores, James (9)	WES	Western

##### 195 LBS.

1st Thorpe, Brian (12)	SJB	St. John Bosco
2nd MosQueda, Jagger (12)	MD	Mater Dei
3rd Eddy, Aaron (12)	YUC	Yucaipa
4th Orozco-Garcia, Gerardo (12)	WES	Western
5th Barrios, Ricardo (10)	CV	Citrus Valley
6th Portillo, Brandon (12)	SRV	Servite
7th Velasco, Calvin (11)	ROY	Royal
8th Olvera, Emanuel (11)	SM	arcos (Santa Barbara)

##### 220 LBS.

1st Sahakian, Nicholas (9)	SJB	St. John Bosco
2nd Kline, Miles (12)	CAM	Camarillo
3rd Hernandez, Alejandro (12)	WES	Western
4th Fulgentes, Peter (9)	ROY	Royal
5th Webb, Luke (9)	JSA	J Serra
6th Martinez, Emmanuel (11)	BEA	Beaumont
7th Leon, Trevor (11)	CV	Citrus Valley
8th Carroll, Jake (11)	SM	arcos (Santa Barbara)

##### 285 LBS.

1st Horta-Aviles, Michael (12)	WES	Western
2nd Prado, Andrew (12)	MAY	Mayfair
3rd Madriajal, Oskar (11)	SRV	Servite
4th Morales, Andrew (12)	SJB	St. John Bosco
5th Floyd, Caleb (11)	YUC	Yucaipa
6th Lora, Jacob (12)	BLO	Bloomington
7th Rodriguez, Andy (11)	LOM	Lompoc
8th Whitney, Jared (12)	OL	Orange Lutheran

#### Team Score

Q	Score
1	St. John Bosco 288.5
2	Servite 6 214.5
3	Yucaipa 8 197.0
4	Mayfair 6 153.0
5	Western 5 151.0
6	Royal 4 135.0
7	Orange Lutheran 3 113.0
8	Camarillo 3 107.0
9	Carter 3 105.0
10	Redlands East Valley 1 72.0
11	Norwalk 2 72.0
12	San Marcos (Santa Bar) 2 67.0
13	Valencia/Valencia 2 59.0
14	Rim of the World 1 56.0
15	Santa Ynez 2 56.0
16	Citrus Valley 2 56.0
17	Fairmont SJC 2 51.5
18	Mater Dei 2 51.0
19	Colton 1 46.0
20	Cajon 2 44.0
21	Beaumont 0 42.0
22	Moorpark 1 36.0
23	Santa Margarita 0 32.0
24	Santa Barbara 0 30.0
25	La Mirada 0 27.0
26	Redlands 0 27.0
27	J Serra 1 26.0
28	Magnolia 0 23.0
29	Dos Pueblos 0 23.0
30	Cabrillo/Lompoc 1 23.0
31	Eisenhower 0 19.0
32	Bloomington 0 18.0
33	Savanna 0 17.0
34	Lompoc 0 17.0
35	Santa Ana Valley 0 12.0
36	Anaheim 0 8.0
37	Faith Baptist 0 6.0
38	Bellflower 0 4.0
39	Simi Valley 0 1.0
40	Desert Christian 0 0.0
41	Firebaugh 0 0.0
42	School 42 0 0.0
43	School 43 0 0.0
44	School 44 0 0.0
45	School 45 0 0.0
46	School 46 0 0.0
47	School 47 0 0.0
48	School 48 0 0.0
49	School 49 0 0.0
50	School 50 0 0.0
51	School 51 0 0.0
52	School 52 0 0.0
53	School 53 0 0.0
54	School 54 0 0.0
55	School 55 0 0.0
56	School 56 0 0.0
57	School 57 0 0.0
58	School 58 0 0.0
59	School 59 0 0.0
60	School 60 0 0.0
61	School 61 0 0.0
62	School 62 0 0.0

2020 CIF Southern Division

Weight Class : 106 LBS.

Carrillo, Mason (10)	ROY	Carrillo, Mason (10)	ROY	Carrillo, Mason (10)	ROY	Carrillo, Mason (10)	ROY		
BYE			0.0	F	:41	6.0			
BYE		Espinoza, Francisco (1)	DP						
Espinoza, Francisco (1)	DP		0.0						
Venegas, Alexander (9)	EIS	Venegas, Alexander (9)	EIS	Venegas, Alexander (9)	EIS	Venegas, Alexander (9)	EIS		
BYE			0.0	F	5:23	6.0			
BYE		Kulkarni, Om (10)	VAL/V						
Kulkarni, Om (10)	VAL/V		0.0						
Casas, Elias (9)	CAJ	Casas, Elias (9)	CAJ	Casas, Elias (9)	CAJ	Casas, Elias (9)	CAJ	Casas, Elias (9)	CAJ
Osorio, Mauricio (11)	MAG	F	4:00	4.0				DEF	13.0
BYE									
BYE		Dye, Austin (9)	SBR	Dye, Austin (9)	SBR	Dye, Austin (9)	SBR		
Dye, Austin (9)	SBR		0.0	F	1:08	4.0			
Soto, Brandon (11)	CAM	Soto, Brandon (11)	CAM	Soto, Brandon (11)	CAM	Soto, Brandon (11)	CAM		
BYE			0.0						
BYE		Dominguez, Jacob (11)	SM	Dominguez, Jacob (11)	SM	Dominguez, Jacob (11)	SM		
Dominguez, Jacob (11)	SM		0.0	F	5:23	6.0			
Cruz, Isaiah (10)	MAY	Cruz, Isaiah (10)	MAY	Cruz, Isaiah (10)	MAY	Cruz, Isaiah (10)	MAY		
BYE			0.0						
BYE		Sullivan, Camren (9)	CAR	Sullivan, Camren (9)	CAR	Sullivan, Camren (9)	CAR		
Sullivan, Camren (9)	CAR		0.0	11	1	5.0			
Mason, Anthony (10)	LM	Mason, Anthony (10)	LM	Mason, Anthony (10)	LM	Mason, Anthony (10)	LM		
BYE			0.0	5	0	5.0			
BYE		Lazaro, Paulino (10)	WES	Lazaro, Paulino (10)	WES	Lazaro, Paulino (10)	WES		
Lazaro, Paulino (10)	WES		0.0	8	5	4.0			
Pacheco, Matthew (12)	SJB	Pacheco, Matthew (12)	SJB	Pacheco, Matthew (12)	SJB	Pacheco, Matthew (12)	SJB		
BYE			0.0						
BYE		Jackson, Jed (9)	RIM	Jackson, Jed (9)	RIM	Jackson, Jed (9)	RIM		
Jackson, Jed (9)	RIM		0.0	F	3:02	6.0			
Preciado, Julian (1)	NWK	Preciado, Julian (1)	NWK	Preciado, Julian (1)	NWK	Preciado, Julian (1)	NWK		
BYE			0.0						
BYE		Poe, Elijah (10)	SRV	Poe, Elijah (10)	SRV	Poe, Elijah (10)	SRV		
Poe, Elijah (10)	SRV		0.0	F	:49	6.0			
BYE									
BYE		Soto, Brandon (11)	CAM	Soto, Brandon (11)	CAM	Soto, Brandon (11)	CAM		
Soto, Brandon (11)	CAM		0.0						
BYE		Dye, Austin (9)	SBR	Dye, Austin (9)	SBR	Dye, Austin (9)	SBR		
Dye, Austin (9)	SBR		0.0	F	3:03	4.0			
Osorio, Mauricio (11)	MAG	Osorio, Mauricio (11)	MAG	Osorio, Mauricio (11)	MAG	Osorio, Mauricio (11)	MAG		
Osorio, Mauricio (11)	MAG		0.0						
BYE		Kulkarni, Om (10)	VAL/V	Kulkarni, Om (10)	VAL/V	Kulkarni, Om (10)	VAL/V		
Kulkarni, Om (10)	VAL/V		0.0						
BYE		Espinoza, Francisco (1)	DP	Espinoza, Francisco (1)	DP	Espinoza, Francisco (1)	DP		
Espinoza, Francisco (1)	DP		0.0	9	6	1.0			
BYE		Mason, Anthony (10)	LM	Mason, Anthony (10)	LM	Mason, Anthony (10)	LM		
Mason, Anthony (10)	LM		0.0	F	4:22	4.0			
BYE		Preciado, Julian (1)	NWK	Preciado, Julian (1)	NWK	Preciado, Julian (1)	NWK		
Preciado, Julian (1)	NWK		0.0						
BYE		Pacheco, Matthew (12)	SJB	Pacheco, Matthew (12)	SJB	Pacheco, Matthew (12)	SJB		
Pacheco, Matthew (12)	SJB		0.0	7	5	2.0			
BYE		Dominguez, Jacob (11)	SM	Dominguez, Jacob (11)	SM	Dominguez, Jacob (11)	SM		
Dominguez, Jacob (11)	SM		0.0	F	2:10	4.0			
BYE		Lazaro, Paulino (10)	WES	Lazaro, Paulino (10)	WES	Lazaro, Paulino (10)	WES		
Lazaro, Paulino (10)	WES		0.0	5	0	3.0			
BYE		Sullivan, Camren (9)	CAR	Sullivan, Camren (9)	CAR	Sullivan, Camren (9)	CAR		
Sullivan, Camren (9)	CAR		0.0	F	3:38	4.0			
BYE		Venegas, Alexander (9)	EIS	Venegas, Alexander (9)	EIS	Venegas, Alexander (9)	EIS		
Venegas, Alexander (9)	EIS		0.0	F	2:18	4.0			
BYE									
BYE		Poe, Elijah (10)	SRV	Poe, Elijah (10)	SRV	Poe, Elijah (10)	SRV		
Poe, Elijah (10)	SRV		0.0	TF	18-3	6.5			
BYE									
BYE		Mason, Anthony (10)	LM	Mason, Anthony (10)	LM	Mason, Anthony (10)	LM		
Mason, Anthony (10)	LM		0.0	F	:49	5.0			
BYE									
BYE		Carrillo, Mason (10)	ROY	Carrillo, Mason (10)	ROY	Carrillo, Mason (10)	ROY		
Carrillo, Mason (10)	ROY		0.0	F	2:02	7.0			
BYE									
BYE		Dominguez, Jacob (11)	SM	Dominguez, Jacob (11)	SM	Dominguez, Jacob (11)	SM		
Dominguez, Jacob (11)	SM		0.0	F	1:19	4.0			
BYE									
BYE		Lazaro, Paulino (10)	WES	Lazaro, Paulino (10)	WES	Lazaro, Paulino (10)	WES		
Lazaro, Paulino (10)	WES		0.0	5	0	3.0			
BYE		Sullivan, Camren (9)	CAR	Sullivan, Camren (9)	CAR	Sullivan, Camren (9)	CAR		
Sullivan, Camren (9)	CAR		0.0	F	2:18	4.0			
BYE									
BYE		Cruz, Isaiah (10)	MAY	Cruz, Isaiah (10)	MAY	Cruz, Isaiah (10)	MAY		
Cruz, Isaiah (10)	MAY		0.0	9	4	5.0			
BYE									
BYE		Dye, Austin (9)	SBR	Dye, Austin (9)	SBR	Dye, Austin (9)	SBR		
Dye, Austin (9)	SBR		0.0						
BYE		Lazaro, Paulino (10)	WES	Lazaro, Paulino (10)	WES	Lazaro, Paulino (10)	WES		
Lazaro, Paulino (10)	WES		0.0	F	1:18	3.0			
BYE									
BYE		Mason, Anthony (10)	LM	Mason, Anthony (10)	LM	Mason, Anthony (10)	LM		
Mason, Anthony (10)	LM		0.0						
BYE		Dominguez, Jacob (11)	SM	Dominguez, Jacob (11)	SM	Dominguez, Jacob (11)	SM		
Dominguez, Jacob (11)	SM		0.0	4	2	2.0			

1st	Poe, Elijah (10)	Servite
2nd	Casas, Elias (9)	Calton
3rd	Carrillo, Mason (10)	Royal
4th	Cruz, Isaiah (10)	Mayfair
5th	Dominguez, Jacob (11)	Marcos (Santa Barbara)
6th	Mason, Anthony (10)	La Mirada
7th	Lazaro, Paulino (10)	Western
8th	Dye, Austin (9)	Santa Barbara



































# CIF SS Boys Ford Masters Wrestling Meet

Sonora High School (La Habra, CA)

February 18-19, 2022



Lower Weight Outstanding Wrestler

Isaiah Quintero  
El Dorado HS  
106 Pounds

Upper Weight Outstanding Wrestler

Caleb Vanbuskirk  
Palm Desert HS  
220 Pounds

Placers			152 Pounds			160 Pounds			170 Pounds			182 Pounds			195 Pounds			220 Pounds			285 Pounds			Team Score Final			
106 Pounds			152 Pounds			160 Pounds			170 Pounds			182 Pounds			195 Pounds			220 Pounds			285 Pounds			1	243.5	78 La Quinta	6
1st	Isaiah Quintero	El Dorado	1st	Nicco Ruiz	St. John Bosco	1st	Luke Gayer	Calvary Chapel (sa)	1st	Erik Mccown	Palm Desert	1st	Timothy Mcdonnell	Fountain Valley	1st	Sonny Kling	Palm Desert	1st	Caleb Vanbuskirk	Palm Desert	1st	Daniel Herrera	Palm Desert	2	239.5	78 Redondo Union	6
2nd	Ronnie Ramirez	Walnut	2nd	Mark Takara	Temecula Valley	2nd	Manuel Gaitan	Temecula Valley	2nd	Evan Gilbert	Calvary Chapel (sa)	2nd	Ryland Whitworth	Fountain Valley	2nd	Ryland Whitworth	Fountain Valley	2nd	Ryan Arrington	San Marino	2nd	Angelo Franco	Serrano	2	199	78 San Jacinto	6
3rd	Paulo Valdez	Hesperia	3rd	Devyn Che	Calvary Chapel (sa)	3rd	Carlos Centeno	Esperanza	3rd	Carlos Centeno	Esperanza	3rd	Brian Thorpe	St. John Bosco	3rd	Brian Thorpe	St. John Bosco	3rd	Nicholas Sahakian	St. John Bosco	3rd	Andrew Prado	Mayfair	3	190.5	78 Schurr	6
4th	Kyle Baldonado	Temecula Valley	4th	Aidan Freeland	Fairmont Sjc	4th	Tyler Hanna	South Torrance	4th	Tyler Hanna	South Torrance	4th	Jetro Preciado	Calvary Chapel (sa)	4th	Jetro Preciado	Calvary Chapel (sa)	4th	Cristian Brito	Westminster	4th	Raymond Macias	Bishop Amat	4	121	78 West Valley (Hemet)	6
5th	Eric Ramirez Jr.	Palm Desert	5th	Billy Dean	Tesoro	5th	Alex Munoz	Valencia/Valencia	5th	Alex Munoz	Valencia/Valencia	5th	Eugenio Franco	Corona Del Mar	5th	Eugenio Franco	Corona Del Mar	5th	Ryan Escamilla	Marina	5th	Michael Horta-Aviles	Western	5	114.5	85 Cypress	5
6th	Jason Saenz	Eleanor Roosevelt	6th	Kydyn Lima	Millikan	6th	Matt York	Temecula Valley	6th	Diego Costa	Yucaipa	6th	Matt Porras Diamond	Temecula Valley	6th	Javier Gonzalez	Norco	6th	Hector Haro	Cathedral City	6th	Isaac Lopez	Centennial/Corona	6	92	85 Estancia	5
7th	Mason Carrillo	Royal	7th	Dominic Jauregui	Ayala	7th	Abraham Galicia	St. John Bosco	7th	Jakob Hand	Centennial/Corona	7th	Alejandro Hernandez	Western	7th	Giovanni Martinez	Centennial/Corona	7th	Alejandro Hernandez	Western	7th	Isaac Lopez	Centennial/Corona	7	78.5	85 Martin Luther King Jr	5
8th	Marcus Tolentino	Northview	8th	Brandon Brown	Paloma Valley	8th	Rafael Guerra	Downey	8th	Isaac Gonzalez	Warren	8th	Tyler Redfield	Calvary Chapel (sa)	8th	Giovanni Martinez	Centennial/Corona	8th	Tyler Redfield	Calvary Chapel (sa)	8th	Levi Banuelos	Fullerton	8	77.5	85 Murrieta Valley	5
9th	Adrian Jimenez	Marina	9th	Hercules Windrath	Fountain Valley	9th	Jack Simons	El Modena	9th	Ethan Gregg	Hemet	9th	Jagger Mosqueda	Mater Dei	9th	Jagger Mosqueda	Mater Dei	9th	Miles Kline	Camarillo	9th	Adan Moreno	Downey	9	60.5	85 Peninsula	5
113 Pounds			160 Pounds			170 Pounds			182 Pounds			195 Pounds			220 Pounds			285 Pounds			11	59.5	85 Vista Murrieta	5			
1st	Christian Garcia	Walnut	1st	Luke Gayer	Calvary Chapel (sa)	1st	Erik Mccown	Palm Desert	1st	Timothy Mcdonnell	Fountain Valley	1st	Sonny Kling	Palm Desert	1st	Caleb Vanbuskirk	Palm Desert	1st	Daniel Herrera	Palm Desert	11	56.5	91 Apple Valley	4			
2nd	Arturo Carranza	Arlington	2nd	Manuel Gaitan	Temecula Valley	2nd	Evan Gilbert	Calvary Chapel (sa)	2nd	Ryland Whitworth	Fountain Valley	2nd	Ryland Whitworth	Fountain Valley	2nd	Ryan Arrington	San Marino	2nd	Angelo Franco	Serrano	12	55.5	91 Arroyo	4			
3rd	Aidan Munoz	Temecula Valley	3rd	Oscar Aranda	St. John Bosco	3rd	Carlos Centeno	Esperanza	3rd	Brian Thorpe	St. John Bosco	3rd	Brian Thorpe	St. John Bosco	3rd	Nicholas Sahakian	St. John Bosco	3rd	Cristian Brito	Westminster	13	48	91 Burroughs	4			
4th	Ethan Guillermo	Palm Desert	4th	Arian Khosravy	Chaminade College Prep Sch	4th	Tyler Hanna	South Torrance	4th	Tyler Hanna	South Torrance	4th	Jetro Preciado	Calvary Chapel (sa)	4th	Jetro Preciado	Calvary Chapel (sa)	4th	Cristian Brito	Westminster	14	47	91 Chapparal	4			
5th	David Fletes	Canyon Springs	5th	Nathan Nichols	Aliso Niguel	5th	Alex Munoz	Valencia/Valencia	5th	Alex Munoz	Valencia/Valencia	5th	Eugenio Franco	Corona Del Mar	5th	Eugenio Franco	Corona Del Mar	5th	Ryan Escamilla	Marina	15	48	91 Corona	4			
6th	Jake McLaughlin	Mater Dei	6th	Joseph Estrada	Yucaipa	6th	Matt York	Temecula Valley	6th	Diego Costa	Yucaipa	6th	Matt Porras Diamond	Temecula Valley	6th	Javier Gonzalez	Norco	6th	Hector Haro	Cathedral City	16	40	91 Corona	4			
7th	Luis Solis	Carter	7th	Vance Frabasilio	San Clemente	7th	Abraham Galicia	St. John Bosco	7th	Jakob Hand	Centennial/Corona	7th	Alejandro Hernandez	Western	7th	Giovanni Martinez	Centennial/Corona	7th	Alejandro Hernandez	Western	17	39.5	91 Lb Poly	4			
8th	James Gauntlett	San Jacinto	8th	Nathan Cruz	Northview	8th	Rafael Guerra	Downey	8th	Isaac Gonzalez	Warren	8th	Tyler Redfield	Calvary Chapel (sa)	8th	Giovanni Martinez	Centennial/Corona	8th	Tyler Redfield	Calvary Chapel (sa)	18	39	91 Los Alamitos	4			
9th	Anthony Lucio	Servite	9th	Julian Barajas	Mayfair	9th	Jack Simons	El Modena	9th	Ethan Gregg	Hemet	9th	Jagger Mosqueda	Mater Dei	9th	Jagger Mosqueda	Mater Dei	9th	Miles Kline	Camarillo	18	39	91 Mission Viejo	4			
120 Pounds			170 Pounds			182 Pounds			195 Pounds			220 Pounds			285 Pounds			19	38	91 San Dimas	4						
1st	Ethan Perryman	Temecula Valley	1st	Erik Mccown	Palm Desert	1st	Timothy Mcdonnell	Fountain Valley	1st	Sonny Kling	Palm Desert	1st	Caleb Vanbuskirk	Palm Desert	1st	Daniel Herrera	Palm Desert	19	38	91 San Dimas	4						
2nd	Richard Murillo	Canyon Springs	2nd	Evan Gilbert	Calvary Chapel (sa)	2nd	Ryland Whitworth	Fountain Valley	2nd	Ryland Whitworth	Fountain Valley	2nd	Ryan Arrington	San Marino	2nd	Angelo Franco	Serrano	20	38	91 Redlands East Valley	4						
3rd	Romero Sanchez	Esperanza	3rd	Carlos Centeno	Esperanza	3rd	Brian Thorpe	St. John Bosco	3rd	Brian Thorpe	St. John Bosco	3rd	Nicholas Sahakian	St. John Bosco	3rd	Andrew Prado	Mayfair	20	38	91 San Dimas	4						
4th	Allan Hendricks	Calvary Chapel (sa)	4th	Tyler Hanna	South Torrance	4th	Tyler Hanna	South Torrance	4th	Jetro Preciado	Calvary Chapel (sa)	4th	Jetro Preciado	Calvary Chapel (sa)	4th	Eugenio Franco	Corona Del Mar	21	38	91 San Dimas	4						
5th	Elijah Flores	Walnut	5th	Alex Munoz	Valencia/Valencia	5th	Alex Munoz	Valencia/Valencia	5th	Alex Munoz	Valencia/Valencia	5th	Eugenio Franco	Corona Del Mar	5th	Eugenio Franco	Corona Del Mar	22	38	91 San Dimas	4						
6th	Adrian Limon	Northview	6th	Matt York	Temecula Valley	6th	Matt York	Temecula Valley	6th	Diego Costa	Yucaipa	6th	Matt Porras Diamond	Temecula Valley	6th	Javier Gonzalez	Norco	22	38	91 San Dimas	4						
7th	Gavin Laverde	Millikan	7th	Abraham Galicia	St. John Bosco	7th	Abraham Galicia	St. John Bosco	7th	Jakob Hand	Centennial/Corona	7th	Alejandro Hernandez	Western	7th	Giovanni Martinez	Centennial/Corona	23	38	91 San Dimas	4						
8th	Jacob Bell	Etiwanda	8th	Rafael Guerra	Downey	8th	Rafael Guerra	Downey	8th	Isaac Gonzalez	Warren	8th	Tyler Redfield	Calvary Chapel (sa)	8th	Giovanni Martinez	Centennial/Corona	23	38	91 San Dimas	4						
9th	Haden Hermadez	Marina	9th	Jack Simons	El Modena	9th	Jack Simons	El Modena	9th	Ethan Gregg	Hemet	9th	Jagger Mosqueda	Mater Dei	9th	Jagger Mosqueda	Mater Dei	24	38	91 San Dimas	4						
126 Pounds			182 Pounds			195 Pounds			220 Pounds			285 Pounds			22	36.5	91 Segerstrom	4									
1st	Brock Mantanona	Palm Desert	1st	Timothy Mcdonnell	Fountain Valley	1st	Sonny Kling	Palm Desert	1st	Caleb Vanbuskirk	Palm Desert	1st	Daniel Herrera	Palm Desert	22	36.5	91 Segerstrom	4									
2nd	Zeth Romney	Chaminade College Prep Sch	2nd	Ryland Whitworth	Fountain Valley	2nd	Ryland Whitworth	Fountain Valley	2nd	Ryan Arrington	San Marino	2nd	Angelo Franco	Serrano	23	36	104 Channel Islands	3									
3rd	Yoshiya Funakoshi	Calvary Chapel (sa)	3rd	Brian Thorpe	St. John Bosco	3rd	Brian Thorpe	St. John Bosco	3rd	Nicholas Sahakian	St. John Bosco	3rd	Andrew Prado	Mayfair	24	36	104 Channel Islands	3									
4th	Grigor Cholakyan	St. John Bosco	4th	Jetro Preciado	Calvary Chapel (sa)	4th	Jetro Preciado	Calvary Chapel (sa)	4th	Jetro Preciado	Calvary Chapel (sa)	4th	Eugenio Franco	Corona Del Mar	26	33	104 Damien	3									
5th	Anthony Pererya	Lakeside	5th	Eugenio Franco	Corona Del Mar	5th	Eugenio Franco	Corona Del Mar	5th	Eugenio Franco	Corona Del Mar	5th	Eugenio Franco	Corona Del Mar	26	33	104 Damien	3									
6th	Mario Sandoval	Northview	6th	Matt Porras Diamond	Temecula Valley	6th	Matt Porras Diamond	Temecula Valley	6th	Jakob Hand	Centennial/Corona	6th	Javier Gonzalez	Norco	26	33	104 Damien	3									
7th	Nathan Perryman	Temecula Valley	7th	Alejandro Hernandez	Western	7th	Alejandro Hernandez	Western	7th	Jakob Hand	Centennial/Corona	7th	Giovanni Martinez	Centennial/Corona	27	33	104 Glendora	3									
8th	Robert Estrada	Highland	8th	Tyler Redfield	Calvary Chapel (sa)	8th	Tyler Redfield	Calvary Chapel (sa)	8th	Isaac Gonzalez	Warren	8th	Tyler Redfield	Calvary Chapel (sa)	27	33	104 Glendora	3									
9th	Peter Mitchell	Foothill (sa)	9th	Jagger Mosqueda	Mater Dei	9th	Jagger Mosqueda	Mater Dei	9th	Ethan Gregg	Hemet	9th	Jagger Mosqueda	Mater Dei	28	33	104 Glendora	3									
132 Pounds			195 Pounds			220 Pounds			285 Pounds			26	33	104 Glendora	3												
1st	Fernando Barreto	Walnut	1st	Sonny Kling	Palm Desert	1st	Caleb Vanbuskirk	Palm Desert	1st	Daniel Herrera	Palm Desert	26	33	104 Glendora	3												
2nd	Devin Avedissian	Temecula Valley	2nd	Ryland Whitworth	Fountain Valley	2nd	Ryan Arrington	San Marino	2nd	Angelo Franco	Serrano	27	33	104 Hueneme	3												
3rd	Joaquin Arroyo	Calvary Chapel (sa)	3rd	Brian Thorpe	St. John Bosco	3rd	Nicholas Sahakian	St. John Bosco	3rd	Andrew Prado	Mayfair	28	33	104 Hueneme	3												
4th	Joseph Antonio	St. John Bosco	4th	Jetro Preciado	Calvary Chapel (sa)	4th	Jetro Preciado	Calvary Chapel (sa)	4th	Eugenio Franco	Corona Del Mar	28	33	104 Hueneme	3												
5th	Julian Leon	Northview	5th	Eugenio Franco	Corona Del Mar	5th	Eugenio Franco	Corona Del Mar	5th	Eugenio Franco	Corona Del Mar	29	33	104 Hueneme	3												
6th	Kris Arrey	Riverside Poly	6th	Matt Porras Diamond	Temecula Valley	6th	Matt Porras Diamond	Temecula Valley	6th	Jakob Hand	Centennial/Corona	30	28.5	104 Laguna Beach	3												
7th	Sean Solis	Fountain Valley	7th	Alejandro Hernandez	Western	7th	Alejandro Hernandez	Western	7th	Jakob Hand	Centennial/Corona	31	28	104 Los Osos	3												
8th	Justin Wells	Lakeside	8th	Tyler Redfield	Calvary Chapel (sa)	8th	Tyler Redfield	Calvary Chapel (sa)	8th	Isaac Gonzalez	Warren	31	28	104 Los Osos	3												
9th	Ethan Qureshi	Portola	9th	Jagger Mosqueda	Mater Dei	9th	Jagger Mosqueda	Mater Dei	9th	Ethan Gregg	Hemet	31	28	104 Los Osos	3												
138 Pounds			220 Pounds			285 Pounds			31	28	104 Norwalk	3															
1st	Beau Mantanona	Palm Desert	1st	Caleb Vanbuskirk	Palm Desert	1st	Daniel Herrera	Palm Desert	31	28	104 Norwalk	3															
2nd	Marcus Medina	Servite	2nd	Ryan Arrington	San Marino	2nd	Angelo Franco	Serrano	32	26.5	104 Rancho Mirage	3															
3rd	Abel Gaitan	Temecula Valley	3rd	Nicholas Sahakian	St. John Bosco	3rd	Brian Thorpe	St. John Bosco	32	26.5	104 Rancho Mirage	3															
4th	Kenneth Rodgers	Esperanza	4th	Cristian Brito	Westminster	4th	Jetro Preciado	Calvary Chapel (sa)	33	25.5	104 Romona	3															
5th	Kade Ayres	Fountain Valley	5th	Ryan Escamilla	Marina	5th	Eugenio Franco	Corona Del Mar	34	25	104 Romona	3															
6th	Aidan Hansen	Royal	6th	Hector Haro	Cathedral City	6th	Matt Porras Diamond	Temecula Valley	35	25	104 Romona	3															
7th	Bryant Avila	Carter	7th	Alejandro Hernandez	Western	7th	Alejandro Hernandez	Western	36	24	104 Victor Valley	3															
8th	Luke Villaluz	Corona Del Mar	8th	Tyler Redfield	Calvary Chapel (sa)	8th	Tyler Redfield	Calvary Chapel (sa)	37	22	116 Barstow	2															
9th	Jack Estevez	Calvary Chapel (sa)	9th	Miles Kline	Camarillo	9th	Jagger Mosqueda	Mater Dei	37	22	116 Barstow	2															
145 Pounds			285 Pounds			220 Pounds			285 Pounds			37	22	116 Barstow	2												
1st	Alec Peralta	Temecula Valley	1st	Daniel Herrera	Palm Desert	1st	Caleb Vanbuskirk	Palm Desert	37	22	116 Barstow	2															
2nd	Koa Ruiz	Calvary Chapel (sa)	2nd	Angelo Franco	Serrano	2nd	Ryan Arrington	San Marino	38	21	116 Citrus Valley	2															
3rd	Zachary Parker	Fountain Valley	3rd	Andrew Prado	Mayfair	3rd	Nicholas Sahakian	St. John Bosco	39	21	116 Citrus Valley	2															
4th	Sammy Mendoza	Yucaipa	4th	Raymond Macias	Bishop Amat	4th	Cristian Brito	Westminster	40	20	116 Newport Harbor	2															
5th	Jacob Salcedo	Northview	5th	Michael Horta-Aviles	Western	5th	Ryan Escamilla	Marina	41	19	120 Bonita	1															
6th	Ryder Yoshitake	San Marino	6th	Isaac Lopez	Centennial/Corona	6th	Hector Haro	Cathedral City	41	19	120 Bonita	1															
7th	Garrett Boyd	San Clemente	7th	Luke Meyer	Capistrano Valley	7th	Alejandro Hernandez	Western	42	19	120 Cabrillo/Lompoc	1															
8th	Kyle Sakuda	Sonora (La Habra)	8th	Levi Banuelos	Fullerton	8th	Tyler Redfield	Calvary Chapel (sa)																			



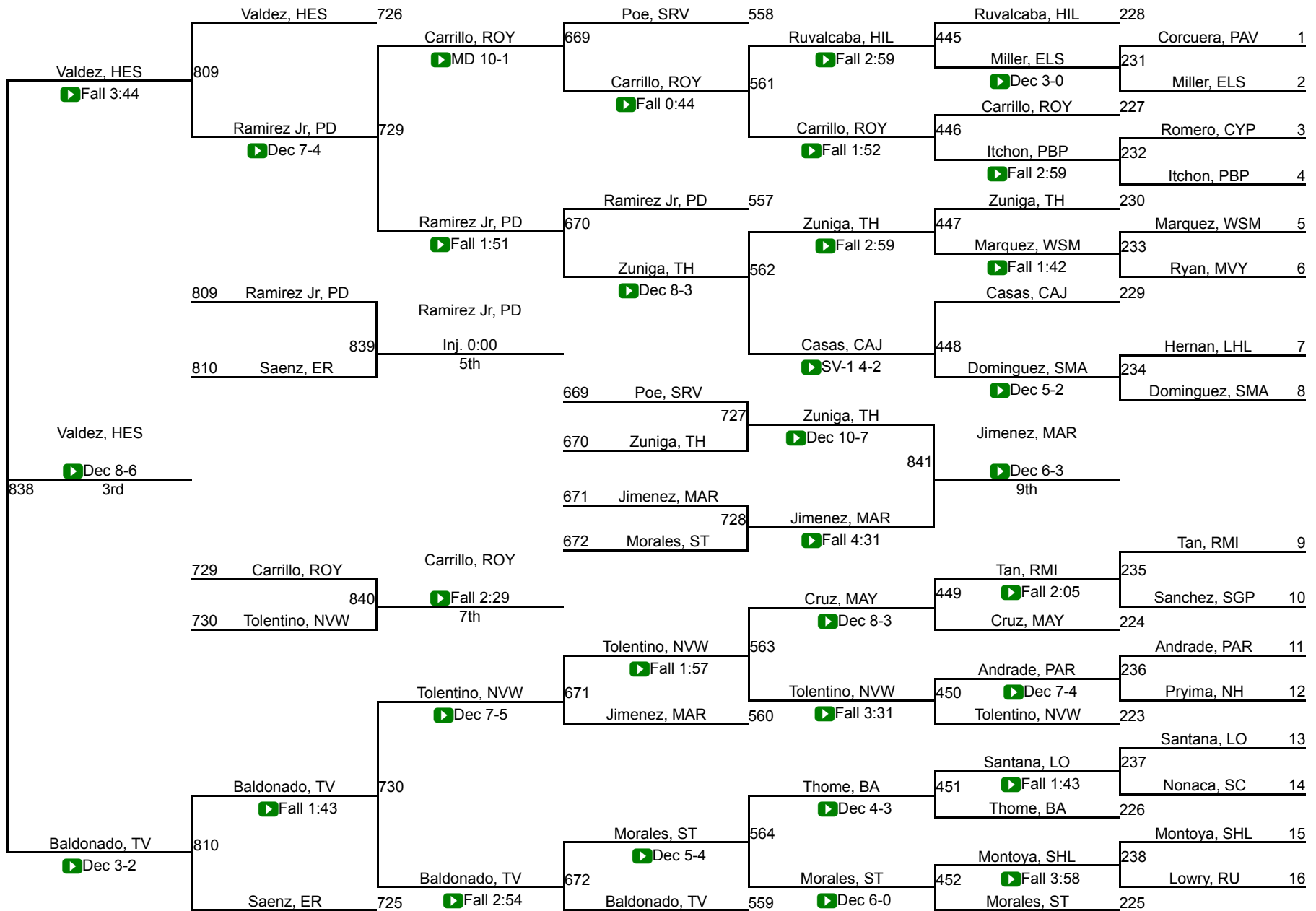



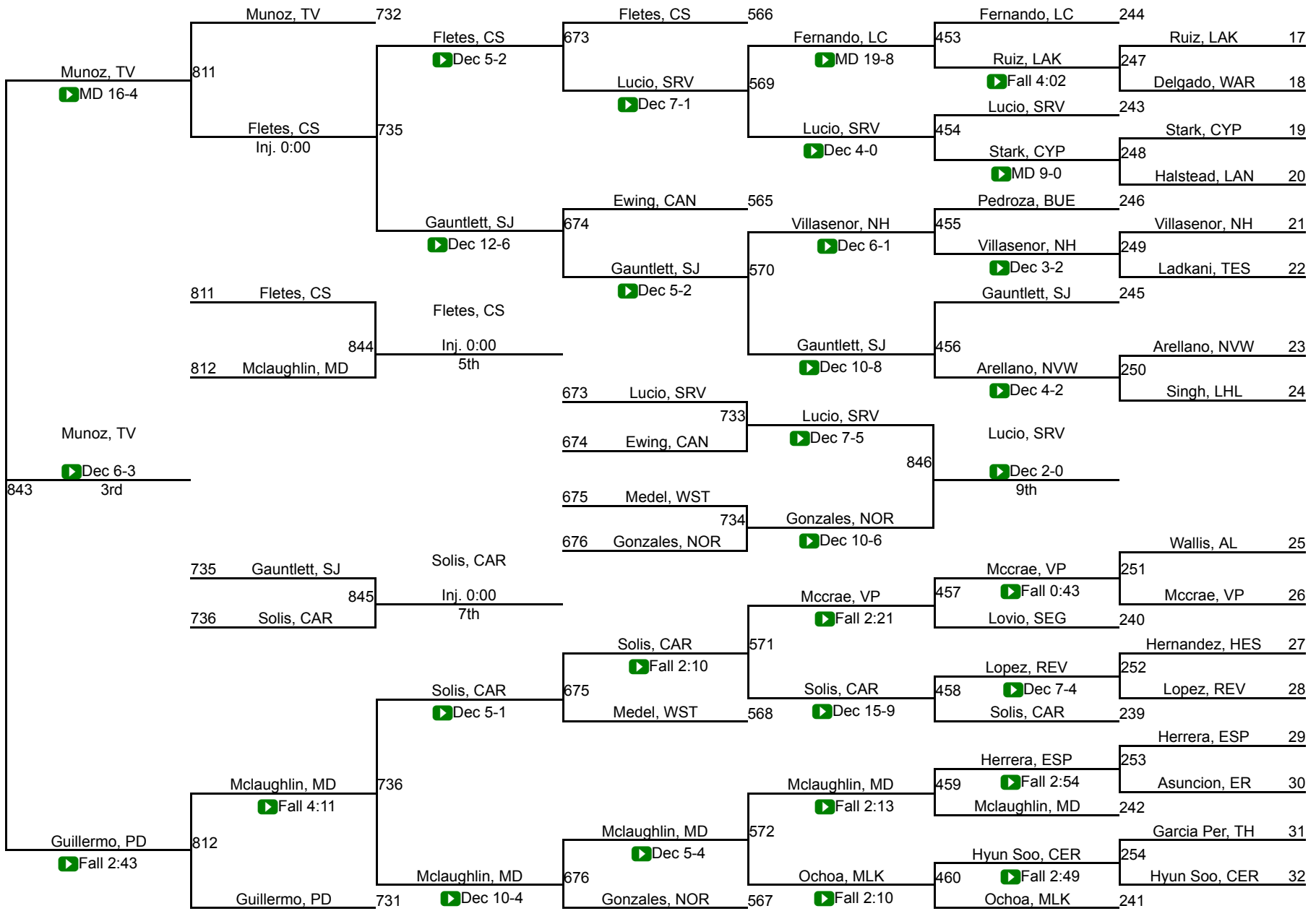





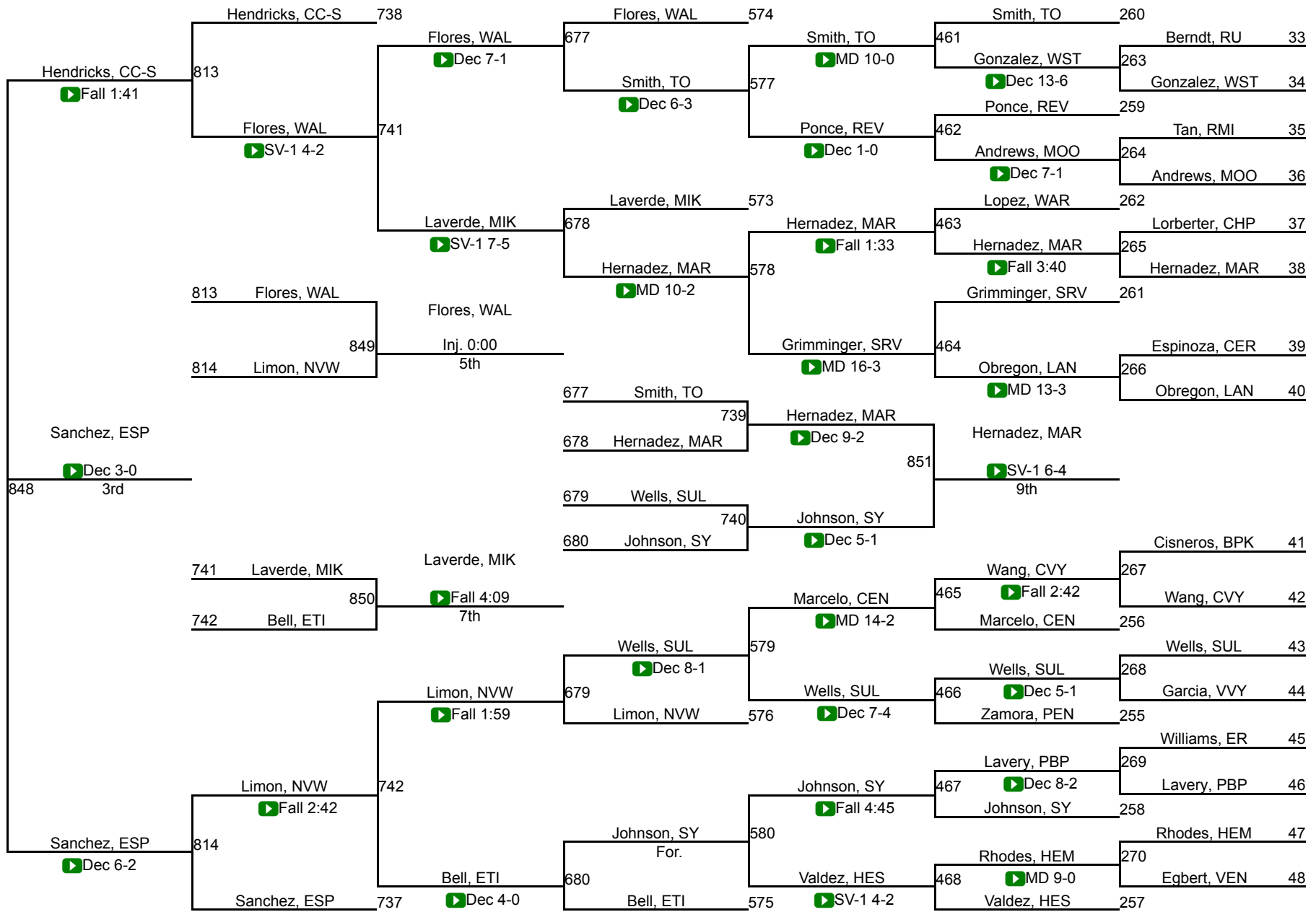

# CIF SS Boys Ford Masters Wrestling Meet

126

Grigor Cholakyan (St. John Bosco) D6-1st (10)					
John Strapp (Corona Del Mar) D3-6th (11)	49	Cholakyan, SJB		Cholakyan, SJB	
Javier Velez (Westminster) D1-4th (12)		▶ Fall 2:36	271	▶ Fall 3:35	
Ian Neeley (Walnut) D4-3rd (11)	50	Neeley, WAL			
Andrew Diaz (Sultana) D5-4th (&n)		▶ Fall 5:15			
Mario Sandoval (Northview) D3-2nd (11)	51	Sandoval, NVW		581	Cholakyan, SJB
Diego S Diego S (Jurupa Valley) D1-5th (12)		▶ MD 14-0	272	▶ Dec 1-0	▶ Dec 2-1
Nathan Perryman (Temecula Valley) D2-2nd (10)	52	Perryman, TV			
Brock Mantanona (Palm Desert) D5-1st (10)		▶ Fall 2:42			743
Alex Newman (Servite) D6-6th (10)	53	Mantanona, PD			Mantanona, PD
Justin Herrera (Chaparral) D2-3rd (11)		▶ Fall 1:16	273		▶ Dec 6-4
Travis Ewing (Esperanza) D3-3rd (12)	54	Ewing, ESP		582	
Kieran Daugherty (Yucaipa) D6-5th (11)		▶ Fall 1:33			Mantanona, PD
Diego Laverde (Millikan) D4-2nd (12)	55	Laverde, MIK			▶ Fall 0:42
Diego Jasso (South Torrance) D5-5th (12)		▶ Dec 8-6	274		
Thomas Le (Laguna Hills) D1-1st (12)	56	Le, LHL			Mantanona, PD
Anthony Pererya (Lakeside) D4-1st (12)		▶ Fall 0:58			▶ Dec 6-4
Vincenzo Bebenati (Aliso Niguel) D2-5th (11)	57	Pererya, LAK			1st
Robert Estrada (Highland) D5-3rd (12)		▶ Fall 2:21	275		852
Emilio Gonzales (Camarillo) D6-3rd (11)	58	Estrada, HIG			
David Guerra (Centennial/Coro) D1-2nd (12)		▶ Fall 2:37			
Isaac Mendoza (El Toro) D2-4th (11)	59	Guerra, CEN		583	
Cristian Mier (Paloma Valley) D4-5th (11)		▶ Fall 3:52	276		Romney, CHA
Zeth Romney (Chaminade Colle) D3-1st (12)	60	Romney, CHA			▶ Fall 2:58
Dustin Serizawa (Orange Lutheran) D6-2nd (12)		▶ Fall 0:48			
Tristan Fernandez (Bonita) D4-4th (9)	61	Serizawa, OL			744
Giovanni Sabatasso (Newport Harbor) D3-5th (12)		▶ Dec 13-9	277		Romney, CHA
Ricardo Valdez (Hesperia) D5-2nd (12)	62	Valdez, HES			▶ Dec 6-4
Jose Garcia (Victor Valley) D1-3rd (12)		▶ Fall 3:58			
Peter Mitchell (Foothill (sa)) D3-4th (12)	63	Mitchell, FOO		584	
Michael Barretto (West Torrance) D5-6th (12)		▶ MD 9-0	278		Funakoshi, CC-S
Yoshiya Funakoshi (Calvary Chapel) D2-1st (12)	64	Funakoshi, CC-S			▶ Fall 2:50
		▶ Fall 0:35			

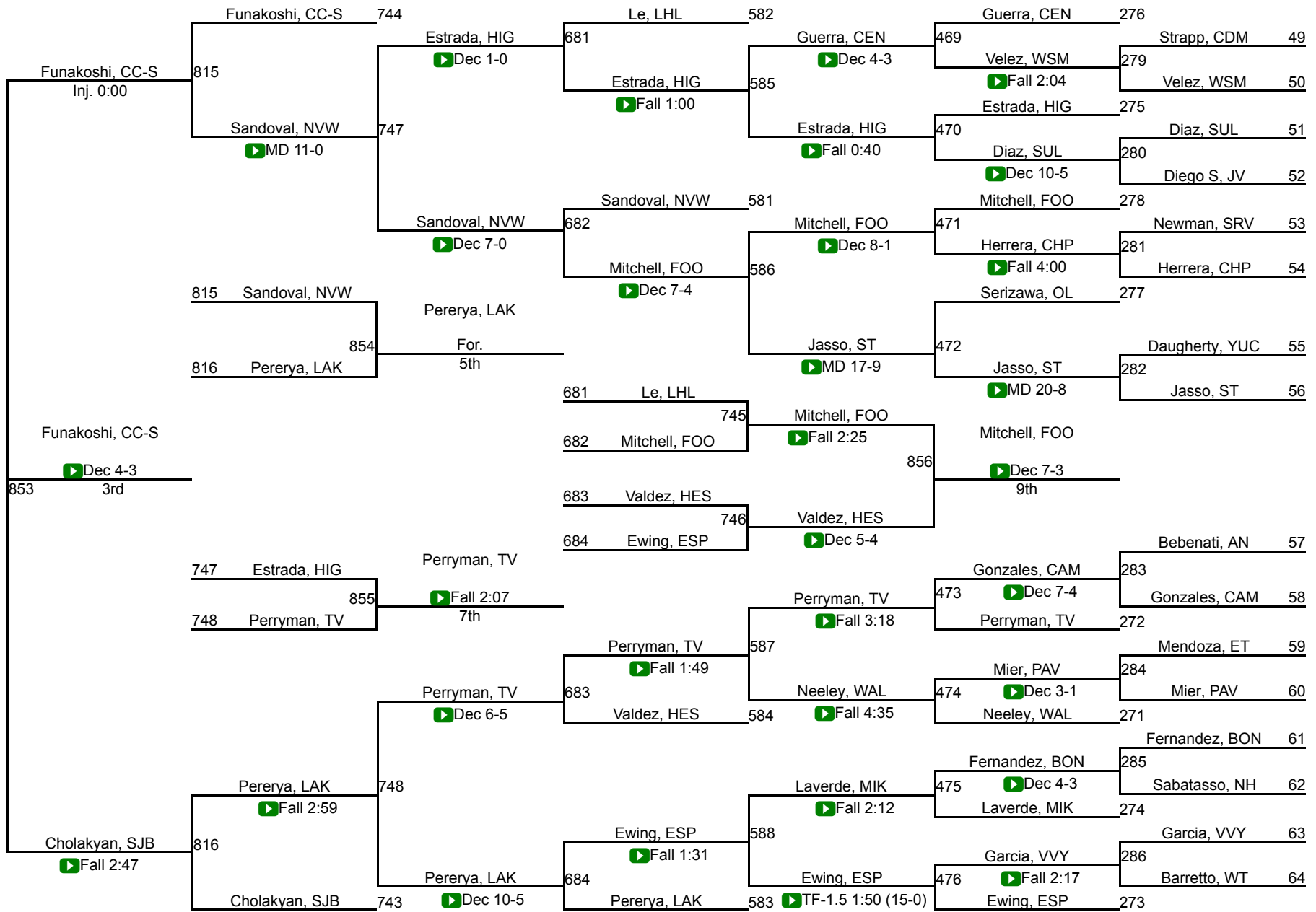

# CIF SS Boys Ford Masters Wrestling Meet

132

Devin Avedissian (Temecula Valley) D2-1st (12)							
Gabe Balingit (Etiwanda) D1-6th (11)	65	Avedissian, TV	▶ Fall 3:26	287	Avedissian, TV	▶ Dec 4-2	
Elijah Robledo (Mayfair) D6-4th (10)		Arrey, RP					
Kris Arrey (Riverside Poly) D4-3rd (11)	66		▶ TF-1.5 3:55 (16-1)		589	Avedissian, TV	▶ Dec 3-1
Gianluca Munoz (Bishop Amat) D3-4th (10)		Fukanaga, WOO					
Enzo Fukanaga (Woodbridge) D1-2nd (&n)	67		▶ Fall 3:11	288	Fukanaga, WOO	▶ Fall 0:46	
Cooper O`neil (Royal) D6-5th (12)		Guillermo, PD					
Dylan Guillermo (Palm Desert) D5-2nd (10)	68		▶ Dec 11-4				
Sean Solis (Fountain Valley) D3-1st (12)		Solis, FV					
Gabriel Canela (Chaparral) D2-5th (11)	69		▶ Fall 2:40	289	Solis, FV	▶ TF-1.5 5:03 (18-1)	
Finn Long (Arroyo) D5-3rd (11)		Long, ARR					
Isaac Rea (Norco) D1-3rd (9)	70		▶ Fall 0:50		590	Antonio, SJB	▶ Fall 4:49
Trevor Wagstaff (Estancia) D2-4th (12)		Wells, LAK					
Justin Wells (Lakeside) D4-2nd (11)	71		▶ Fall 1:00	290	Antonio, SJB	▶ Dec 4-0	
Viviano Gutierrez (Sonora (La Habr) D3-5th (10)		Antonio, SJB					
Joseph Antonio (St. John Bosco) D6-1st (9)	72		▶ Fall 4:51				
Fernando Barreto (Walnut) D4-1st (12)		Barreto, WAL					
Daniel Simons (Camarillo) D6-6th (12)	73		Fall 0:00	291	Barreto, WAL	▶ Fall 1:46	
Jordan Mallo (Chino) D3-3rd (11)		Mallo, CHI					
Benjamin Hernandez (San Clemente) D2-3rd (11)	74		▶ Dec 3-1		591	Barreto, WAL	▶ MD 15-5
Lucas Paschia (Valencia/Valenc) D6-2nd (12)		Paschia, VA-V					
Jaden Boquete (Paramount) D5-5th (10)	75		▶ Dec 6-0	292	Qureshi, POR	▶ MD 13-4	
Ezekiel Lazcano (Hueneme) D4-5th (12)		Qureshi, POR					
Ethan Qureshi (Portola) D1-1st (12)	76		▶ Fall 4:36				
Joaquin Arroyo (Calvary Chapel ) D2-2nd (12)		Arroyo, CC-S					
Samuel Winters (Millikan) D4-4th (12)	77		▶ Fall 0:53	293	Arroyo, CC-S	▶ Dec 3-1	
Cade Braun (Centennial/Coro) D1-5th (12)		Leon, NVW					
Julian Leon (Northview) D3-2nd (12)	78		▶ Fall 5:57		592	Arroyo, CC-S	▶ TF-1.5 4:07 (15-0)
Anthony Zuniga (Carter) D6-3rd (11)		Leon, ER					
Brian Leon (Eleanor Roosevelt) D1-4th (10)	79		▶ TF-1.5 5:28 (20-5)	294	Leon, ER	▶ Fall 1:24	
Seth Delgado (Paloma Valley) D4-6th (12)		Roy, BUR					
Evan Roy (Burroughs) D5-1st (&n)	80		▶ Fall 1:40				
749 Avedissian, TV ▶ Dec 3-2							
750 Barreto, WAL ▶ Dec 11-4 1st 857							
750 Barreto, WAL ▶ Fall 0:54							

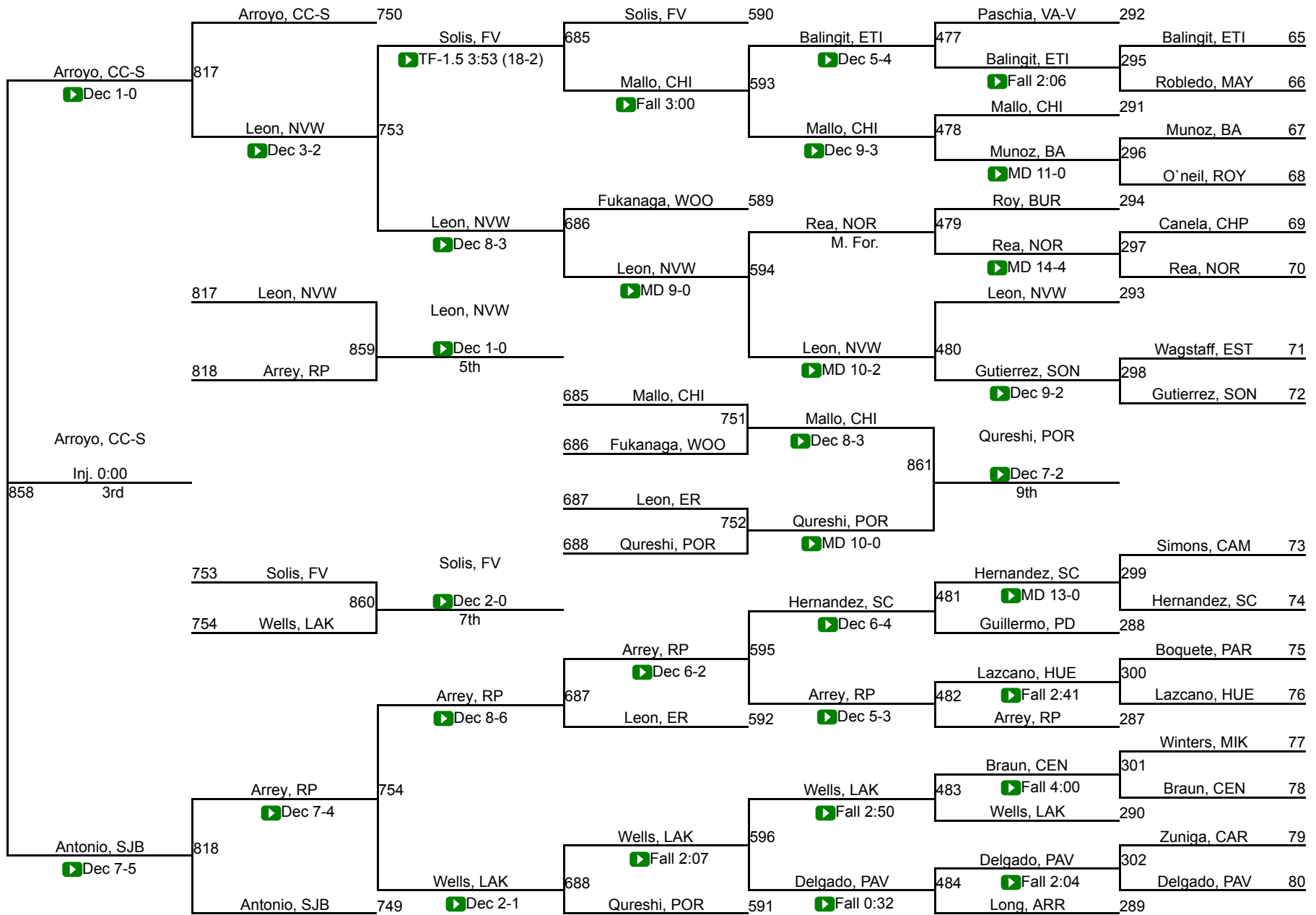

# CIF SS Boys Ford Masters Wrestling Meet

138

Noah Elliott (Chaminade Colle) D3-1st (11)		Elliott, CHA				
Isaac Hernandez (Oak Hills) D5-6th (&n)	81	Fall 1:36	303	Elliott, CHA		
Charley Newman (Buena) D5-4th (12)		Tellez, SJB		Fall 2:59		
Yazir Tellez (St. John Bosco) D6-3rd (10)	82	Fall 3:20				
Avian Singh (Victor Valley) D1-4th (10)		Gaitan, TV			597	Gaitan, TV
Abel Gaitan (Temecula Valley) D2-2nd (12)	83	Fall 3:10	304	Gaitan, TV		Fall 3:56
Felicito Nunez (Shadow Hills) D5-5th (10)		Castillilo, MIK		Fall 3:05		
Alister Castillilo (Millikan) D4-2nd (11)	84	Dec 8-4				
Aldo Quintero (Centennial/Coro) D1-1st (12)		Quintero, CEN				755
Jacob Leon (Northview) D3-5th (12)	85	Fall 3:29	305	Maxwell, EST		Mantanona, PD
Dakota Rhodes (Hemet) D4-3rd (12)		Maxwell, EST		Dec 2-1		Fall 4-0
Zach Maxwell (Estancia) D2-3rd (12)	86	Dec 5-0				
Luke Villaluz (Corona Del Mar) D3-4th (12)		Avila, CAR			598	Mantanona, PD
Bryant Avila (Carter) D6-2nd (12)	87	Dec 8-4	306	Mantanona, PD		Fall 1:27
Victor Figueroa (Westminster) D1-5th (12)		Mantanona, PD		M. For.		
Beau Mantanona (Palm Desert) D5-1st (11)	88	Fall 0:20				Mantanona, PD
Marcus Medina (Servite) D6-1st (12)		Medina, SRV				Fall 1:10
Joesph Christenson (Lb Poly) D4-5th (11)	89	Fall 1:36	307	Medina, SRV		1st 862
Nathaniel Chang (Corona) D1-3rd (12)		Rodgers, ESP		Dec 8-3		
Kenneth Rodgers (Esperanza) D3-3rd (11)	90	Fall 1:32			599	Medina, SRV
Heric Obregon (Lancaster) D5-2nd (11)		Obregon, LAN				Dec 9-5
Jonathon Perdomo (Romona) D4-4th (12)	91	TF-1.5 5:40 (17-0)	308	Estevez, CC-S		
Xander Dewitt (Yucaipa) D6-5th (11)		Estevez, CC-S		Fall 2:22		
Jack Estevez (Calvary Chapel ) D2-1st (10)	92	Fall 1:58				756
Kade Ayres (Fountain Valley) D3-2nd (12)		Ayres, FV				Medina, SRV
Andrew Lopez (Cajon) D6-4th (12)	93	Fall 3:33	309	Ayres, FV		Dec 5-4
Dominic Morales (San Clemente) D2-5th (11)		Fajardo, LHL		Dec 7-3		
Carlos Fajardo (Laguna Hills) D1-2nd (12)	94	Dec 10-4			600	Ayres, FV
Larry Cruz (Arroyo) D5-3rd (11)		Asbury, TH				Dec 5-3
Andrew Asbury (Trabuco Hills) D2-4th (11)	95	Fall 3:09	310	Hansen, ROY		
Aidan Hansen (Royal) D6-6th (12)		Hansen, ROY		Fall 2:47		
Elijah Benavidez (Paloma Valley) D4-1st (11)	96	Dec 11-7				



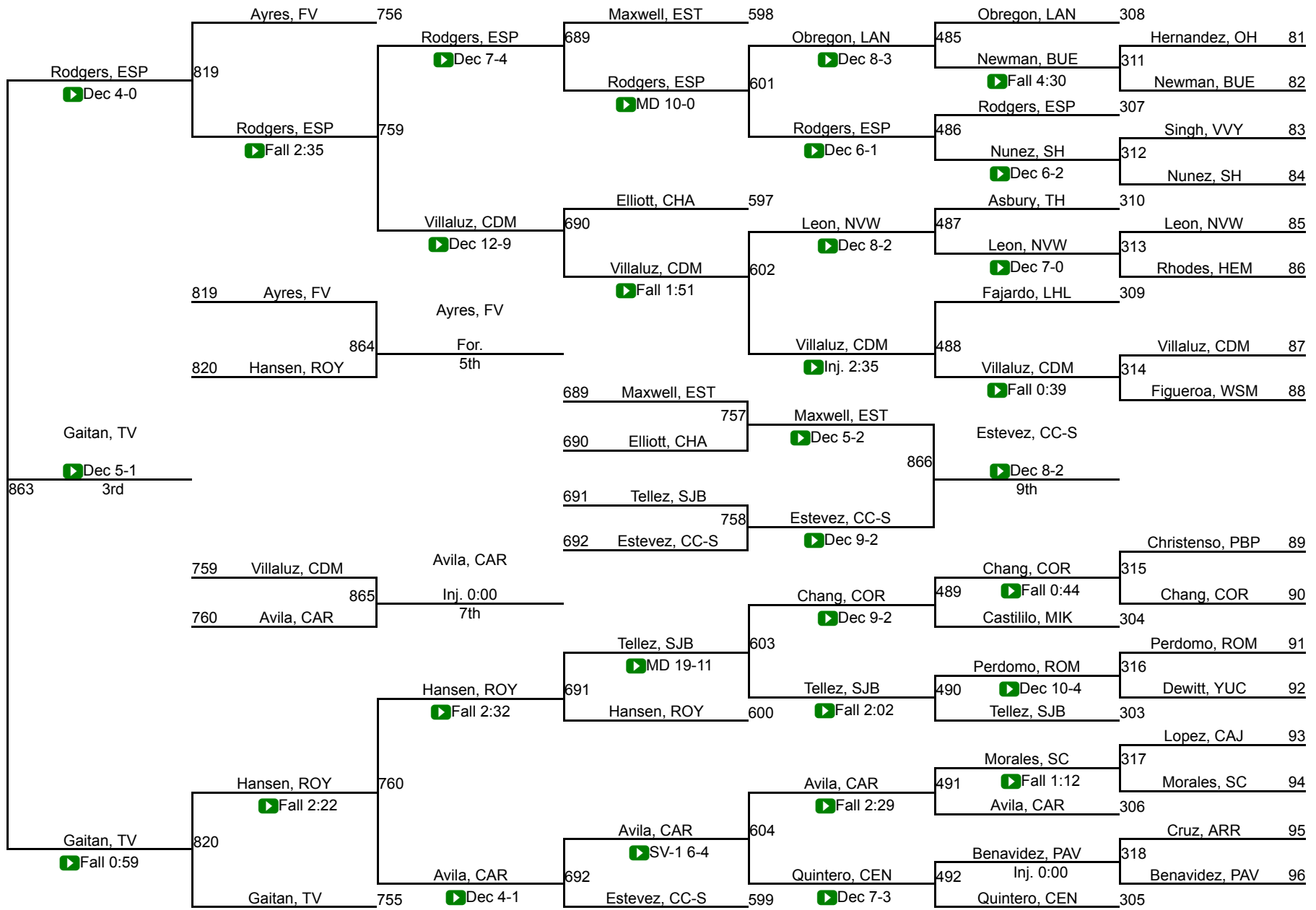



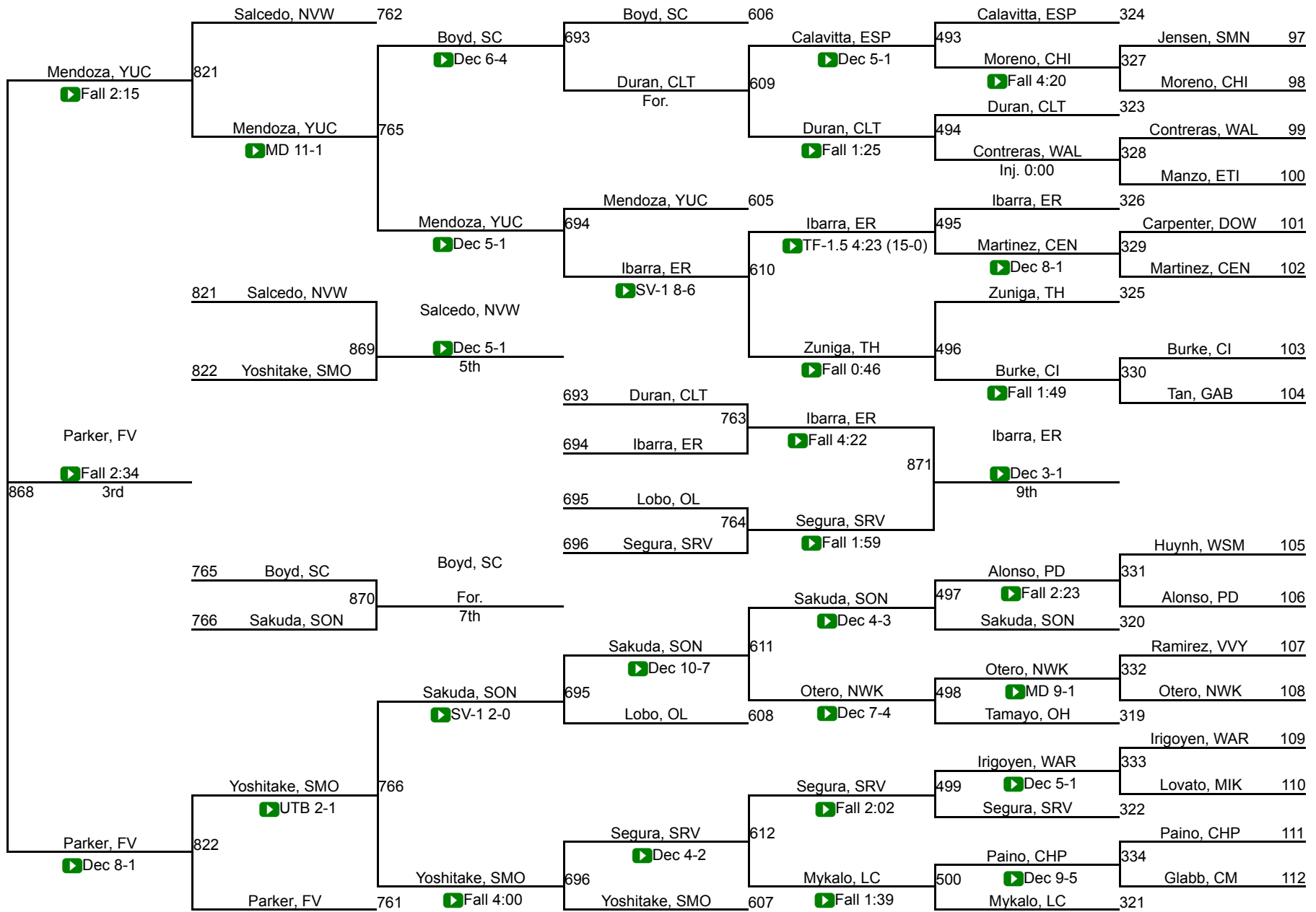

# CIF SS Boys Ford Masters Wrestling Meet

152

Nicco Ruiz (St. John Bosco) D6-1st (11)		Ruiz, SJB			
Zion Hernandez (Corona Del Mar) D3-6th (10)	113	▶ Fall 1:09	335	Ruiz, SJB	
Ace Garcia (Yorba Linda) D3-4th (12)		▶ Dean, TES		▶ Fall 0:56	
Billy Dean (Tesoro) D2-3rd (12)	114	▶ MD 13-4		613	Ruiz, SJB
Kevin Courseault (Etiwanda) D1-4th (12)		Lima, MIK		▶ TF-1.5 5:21 (16-1)	
Kydyn Lima (Millikan) D4-2nd (12)	115	▶ Fall 1:24	336	Lima, MIK	
Sonny Acuna Zepeda (Northview) D3-5th (10)		▶ Acuna Zepe, NVW		▶ Fall 1:43	
Evan Sepanlou (Quartz Hill) D5-2nd (10)	116	▶ Fall 5:01		767	Ruiz, SJB
Javier Montes (Centennial/Coro) D1-1st (11)		Dunwoody, OL		▶ Fall 3:35	
Lance Dunwoody (Orange Lutheran) D6-5th (11)	117	▶ Dec 11-4	337	Brown, PAV	
Luke Vanbuskirk (Palm Desert) D5-4th (10)		▶ Brown, PAV		▶ Fall 5:14	
Brandon Brown (Paloma Valley) D4-3rd (12)	118	▶ Fall 3:18		614	Che, CC-S
Jeremiah Voce (Rim Of The Worl) D6-4th (12)		Che, CC-S		▶ MD 17-5	
Devyn Che (Calvary Chapel ) D2-2nd (12)	119	▶ Fall 1:36	338	Che, CC-S	
Joeseph Perez (Chino Hills) D1-5th (11)		▶ Windrath, FV		▶ Dec 4-0	
Hercules Windrath (Fountain Valley) D3-1st (10)	120	▶ Fall 1:51			Ruiz, SJB
Mark Takara (Temecula Valley) D2-1st (12)		Takara, TV			▶ Dec 6-1
Amin Derekhshan (University) D1-6th (12)	121	▶ Fall 0:50	339	Takara, TV	1st 872
Damian Soto (Barstow) D1-3rd (12)		▶ Soto, BAR		▶ Fall 1:25	
Mason Hernandez (Citrus Valley) D6-3rd (10)	122	▶ Dec 5-4		615	Takara, TV
Arvin Khosravy (Chaminade Colle) D3-2nd (10)		Khosravy, CHA		▶ MD 14-1	
Justin Yu (West Torrance) D5-5th (12)	123	▶ Fall 5:19	340	Jauregui, AYA	
Tyler Thienngern (Cypress) D2-5th (11)		▶ Jauregui, AYA		▶ Dec 10-9	
Dominic Jauregui (Ayala) D4-1st (12)	124	▶ Fall 1:44		768	Takara, TV
Aidan Freeland (Fairmont Sjc) D6-2nd (12)		Freeland, FAI		▶ Dec 3-1	
Luciano Benenati (Aliso Niguel) D2-4th (11)	125	▶ Fall 5:31	341	Freeland, FAI	
Patrick Serio (South Hills) D4-5th (12)		▶ Blair, RU		▶ TF-1.5 4:00 (20-5)	
Brevin Blair (Redondo Union) D1-2nd (12)	126	▶ Dec 8-4		616	Freeland, FAI
Julius Soria (Chino) D3-3rd (11)		▶ Soria, CHI		▶ Dec 6-2	
Derrick Meza (Walnut) D4-4th (12)	127	▶ MD 12-2	342	Jeong, OH	
Eli Ocampo (Lakewood) D4-6th (12)		▶ Jeong, OH		▶ SV-1 6-4	
Julian Jeong (Oak Hills) D5-1st (&n)	128	▶ TF-1.5 4:56 (20-5)			



# CIF SS Boys Ford Masters Wrestling Meet

160

Oscar Aranda (St. John Bosco) D6-1st (12)		Aranda, SJB					
Adin Gallegos (Corona Del Mar) D3-6th (10)	129	Fall 0:32	351	Aranda, SJB	Fall 0:30		
Chet Lewis (South Hills) D4-4th (12)		Nichols, AN					
Nathan Nichols (Aliso Niguel) D2-3rd (11)	130	Fall 1:37					
Noah Morris (Palm Desert) D5-4th (12)		Morris, PD					
Noah Vasquez (Eleanor Roosevelt) D1-2nd (9)	131	Fall 2:53	352	Cruz, NVW	Fall 3:09		
Marquize Brown (Glendora) D4-5th (11)		Cruz, NVW					
Nathan Cruz (Northview) D3-2nd (11)	132	Fall 1:56					
John Miller (Buena) D5-1st (11)		Miller, BUE					
Juan Torres (San Marcos (San)) D6-5th (12)	133	Dec 10-5	353	Jaramillo, YL	Fall 1:47		
Mateo Jaramillo (Yorba Linda) D3-3rd (12)		Jaramillo, YL					
Benedek Magyar (Irvine) D1-3rd (11)	134	MD 12-2					
Jonah Fryer (Norwalk) D6-4th (12)		Gayer, CC-S					
Luke Gayer (Calvary Chapel ) D2-2nd (12)	135	Fall 3:00	354	Gayer, CC-S	MD 12-2		
Roger Castro (El Monte) D5-5th (12)		Pallares, MIK					
Jake Pallares (Millikan) D4-1st (12)	136	Fall 0:55					
Manuel Gaitan (Temecula Valley) D2-1st (12)		Gaitan, TV					
Seth Hoodye (San Dimas) D3-5th (11)	137	Fall 0:27	355	Gaitan, TV	Fall 1:27		
Dylan Bentz (Oak Hills) D5-3rd (&n)		Estrada, YUC					
Joseph Estrada (Yucaipa) D6-3rd (12)	138	Dec 7-0					
Junya Ishida (La Canada) D4-2nd (12)		Haroun, VP					
Roy Haroun (Villa Park) D3-4th (11)	139	OT 6-5	356	Ortiz, RC	Fall 2:36		
Victor Rodarte (Tesoro) D2-5th (11)		Ortiz, RC					
Dayton Ortiz (Rancho Cucamong) D1-1st (12)	140	Dec 10-6					
Julian Barajas (Mayfair) D6-2nd (11)		Barajas, MAY					
Vance Frabasilio (San Clemente) D2-4th (12)	141	Dec 9-3	357	Barajas, MAY	Fall 1:26		
Anthony Porter (Martin Luther K) D1-5th (10)		Guzman, LAW					
Trystan Guzman (Lawndale) D5-2nd (12)	142	MD 18-7					
Daniel Baker (Schurr) D4-3rd (12)		Rodriguez, GG					
Adrien Rodriguez (Garden Grove) D1-4th (12)	143	Fall 2:34	358	Khosravy, CHA	Fall 1:42		
Nicholas Madrigal (Royal) D6-6th (11)		Khosravy, CHA					
Arian Khosravy (Chaminade Colle) D3-1st (12)	144	MD 14-1					

621	Aranda, SJB	Fall 0:38	773	Gayer, CC-S	Dec 3-2	
622	Gayer, CC-S	Fall 3:04		Gayer, CC-S	UTB 3-2	1st 877
623	Gaitan, TV	Fall 0:37	774	Gaitan, TV	Fall 3:53	
624	Khosravy, CHA	Dec 11-10				





# CIF SS Boys Ford Masters Wrestling Meet

170

Evan Gilbert (Calvary Chapel ) D2-1st (12)					
Shea Gabriel (Oak Hills) D5-6th (&n)	145	Gilbert, CC-S	Fall 2:52	367	Gilbert, CC-S
Francisco Maldonado (Mayfair) D6-4th (12)		Montes, CEN	MD 9-0		Fall 3:05
Ray Montes (Centennial/Coro) D1-3rd (12)	146				
Blake Chaffee (Serrano) D5-4th (&n)		Chaffee, SER	TF-1.5 5:32 (21-5)	368	Chaffee, SER
Jonathan Granado (Temescal Canyon) D4-4th (12)	147				Fall 2:57
Daniel Gurovich (Camarillo) D6-5th (11)		Simons, EMD	Fall 2:46		
Jack Simons (El Modena) D3-2nd (12)	148				
Tyler Hanna (South Torrance) D5-1st (12)		Hanna, ST	Fall 3:00	369	Hanna, ST
Indiana Fightmaster (San Clemente) D2-5th (12)	149				Dec 7-1
Kristopher Castro (Chaminade Colle) D3-3rd (11)		Castro, CHA	Dec 10-3		
Broderick Foster (Hillcrest) D4-5th (11)	150				
Juan Segura (Capistrano Vall) D2-4th (12)		Grundmeyer, NOR	Fall 4:12	370	Munoz, VA-V
John Grundmeyer (Norco) D1-2nd (12)	151				Fall 4:18
Warren Koslow (Marshall) D5-5th (12)		Munoz, VA-V	MD 10-2		
Alex Munoz (Valencia/Valenc) D6-1st (11)	152				
Carson Thoe (Laguna Hills) D1-1st (12)		Madrigal, NVW	Fall 3:26	371	Galicia, SJB
Lewis Madrigal (Northview) D3-5th (12)	153				Fall 2:38
Abraham Galicia (St. John Bosco) D6-3rd (12)		Galicia, SJB	Fall 3:24		
Michael Mcgettigan (Tesoro) D2-3rd (12)	154				
Erik Mccown (Palm Desert) D5-2nd (11)		Mccown, PD	Fall 1:07	372	Mccown, PD
Khale Mcdonnell (Fountain Valley) D3-4th (9)	155				Fall 0:35
Devin Mccaw (Los Osos) D1-5th (12)		Major, PAV	TF-1.5 4:00 (17-2)		
Javon Major (Paloma Valley) D4-2nd (9)	156				
Matt York (Temecula Valley) D2-2nd (12)		York, TV	Fall 2:49	373	York, TV
Demetri Cantrell (Eleanor Roosevelt) D1-4th (12)	157				Dec 6-4
Bryan Gomez (Etiwanda) D1-6th (12)		Martindale, YUC	Fall 3:01		
Nathaniel Martindale (Yucaipa) D6-2nd (12)	158				
Rafael Guerra (Downey) D5-3rd (12)		Guerra, DOW	Fall 1:34	374	Centeno, ESP
Brian Ho (Colony) D4-6th (12)	159				Fall 1:02
Farid Sawaya (Valencia (Place) D2-6th (11)		Centeno, ESP	Fall 0:44		
Carlos Centeno (Esperanza) D3-1st (12)	160				

629	Gilbert, CC-S	Fall 0:55
779	Gilbert, CC-S	Dec 4-2
630	Hanna, ST	Dec 4-3
882	Mccown, PD	Fall 2:37
1st		
631	Mccown, PD	Fall 0:41
780	Mccown, PD	Fall 3:22
632	Centeno, ESP	Dec 5-0

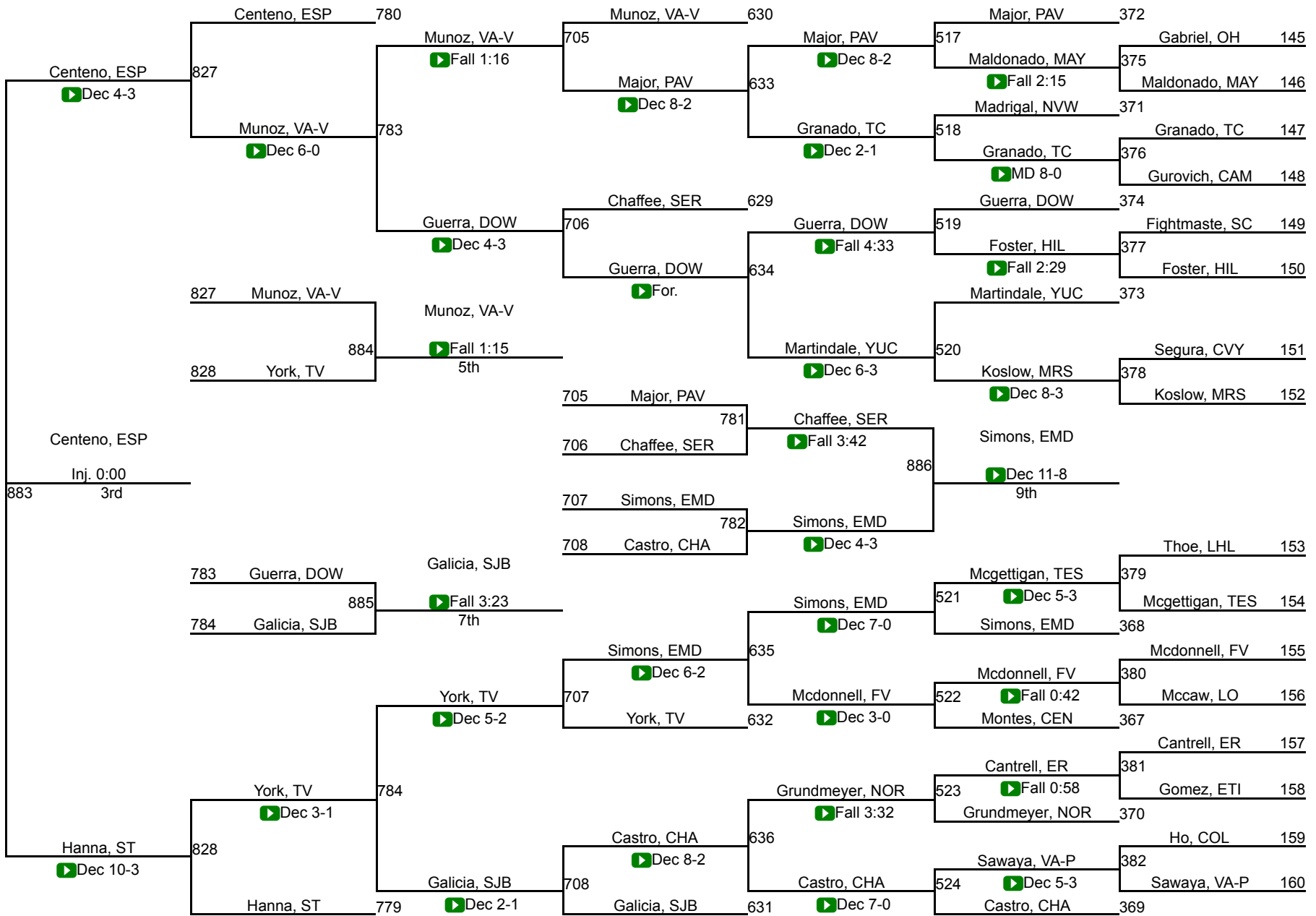

# CIF SS Boys Ford Masters Wrestling Meet

182

Isaiah Morales (Cathedral City) D2-1st (12)		Morales, CCY			
Javier Castaneda (Romona) D4-6th (11)	161	▶ Fall 1:05	383	Morales, CCY	
Max McWilliams (Fairmont Sjc) D6-4th (10)		Vasquez, WSM		▶ Fall 1:59	
Ruben Vasquez (Westminster) D1-3rd (&n)	162	▶ Fall 4:20			
Isiah Castellanos (Buena) D5-4th (12)		Gregg, HEM		637	Morales, CCY
Ethan Gregg (Hemet) D4-2nd (12)	163	▶ Fall 3:12	384	Gregg, HEM	▶ Dec 6-0
Angel Martinez (Cabrillo/Lompoc) D6-5th (12)		Sandoval, VP		▶ Fall 1:30	
Christophe Sandoval (Villa Park) D3-2nd (12)	164	▶ Dec 7-6			
Tanner Chaffee (Serrano) D5-1st (&n)		Chaffee, SER		785	Morales, CCY
Ray Gulmatico (Calvary Chapel ) D2-5th (12)	165	▶ Dec 6-1	385	Chaffee, SER	▶ Dec 4-3
Luke Ewell (Los Alamitos) D3-3rd (12)		Ewell, LAM		▶ Dec 9-8	
Daniel Diaz (Paloma Valley) D4-3rd (11)	166	▶ Dec 8-3		638	Ayala, SJB
Daniel Dominguez (Mission Viejo) D2-4th (12)		Hand, CEN		▶ Fall 1:23	
Jakob Hand (Centennial/Coro) D1-2nd (12)	167	▶ Dec 5-2	386	Ayala, SJB	
Bronson Swan (Palm Desert) D5-5th (11)		Ayala, SJB		▶ Fall 3:48	
Mark Ayala (St. John Bosco) D6-1st (11)	168	▶ Fall 2:31			Mcdonnell, FV
Caleb Smith (Etiwanda) D1-1st (11)		Catalano, CHA			▶ Dec 9-3
Primo Catalano (Chaminade Colle) D3-5th (9)	169	▶ Dec 10-5	387	Catalano, CHA	1st 887
Zerek Zeman (Oxnard) D5-3rd (12)		Franklin, VM		▶ UTB 3-3	
Victor Franklin (Vista Murrieta) D2-3rd (12)	170	▶ Fall 3:26		639	Costa, YUC
Diego Costa (Yucaipa) D6-2nd (10)		Costa, YUC			For.
Jeremy Kanter (Laguna Beach) D3-4th (11)	171	▶ Fall 1:58	388	Costa, YUC	
Austin South (Norco) D1-5th (11)		Brown, CS		▶ MD 17-6	
Samuel Brown (Canyon Springs) D4-1st (12)	172	▶ Fall 3:16			786
Nico Turturro (Temecula Valley) D2-2nd (12)		Turturro, TV			Mcdonnell, FV
Dontae Sheng (Peninsula) D1-4th (12)	173	▶ Dec 4-2	389	Gonzalez, WAR	▶ MD 13-3
Eric Race (Alta Loma) D4-5th (12)		Gonzalez, WAR		▶ Dec 7-4	
Isaac Gonzalez (Warren) D5-2nd (12)	174	▶ Fall 3:26		640	Mcdonnell, FV
William Fulgentes (Royal) D6-3rd (12)		Fulgentes, ROY			▶ Fall 1:12
Marco Rodriguez (Schurr) D4-4th (11)	175	▶ TF-1.5 6:00 (17-2)	390	Mcdonnell, FV	
Matthew Bahra (La Mirada) D6-6th (9)		Mcdonnell, FV		▶ Fall 1:43	
Timothy Mcdonnell (Fountain Valley) D3-1st (11)	176	▶ Fall 0:31			

